



Vendor 	ABT 360 KT/Y PP PLANT Project		Owner  سراج گستران رجال SERAJ GOSTARAN REJAL (سهایی خاص)
	NDE procedure		
	Vendor's Doc. No.: 23249-15	Rev.: 00	
PPEC Doc. No.: L03-RE037-QC-PCJ-002			



PPEC REQ. NO. : L03-RE037-QC-PCJ-002

ITEM NO. :

TOTAL PAGES : 60

<ul style="list-style-type: none"> ○ NO COMMENTS : Documents/Drawings Were Checked By PPEC And Further Step Can Be Followed. ○ COMMENTED AS MARKED: Documents/Drawings Were Checked By PPEC And Marked Comments Must Be Considered By Vendor. Vendor Shall Revise Documents/Drawing As Per Comments And The New Revision Of Documents/Drawings Must Be Revised Prior To Fabrication. ○ REJECTED: Documents/Drawings Were Checked And It Is Not In Comply With Purchase Requisition Requirements. ○ ACCEPTABLE WITH COMMENTS: Documents/Drawings Were Checked By PPEC And Comments Must Be Considered By Vendor. Fabrication Can Proceed Accordingly. Revised Document To Be Issued Either For Review Or As Final Certified. However PPEC Will Check The Revised Document For Proper Incorporation Of Comments. ○ NOT RETURNED: Document Was Received For Information And Not Returned To The Vendor. 		
Name :	Req. No. :	Seq. No.:
Signature:		
Date :		
PPEC review & comments does not absolve the vendor of the responsibility for the corrected design, manufacturing and operation of the equipment		

00	18-04-2025	Issue for Engineering	S.K.	S.K.	J.J.	
REV.	DATE	Description	Prepared by	Checked by	Approved by	Authorized by

Vendor 	ABT 360 KT/Y PP PLANT		Contractor (DEC)	Owner  سراج گستران رجال SERAJ GOSTARAN REJAL (سهامی خاص)
	NDE procedure			
	Vendor's Doc. No.: 2 3 2 4 9 - 1 5	Rev.: 00		
PPEC Doc. No.: L03-RE037-QC-PCJ-002				

PAGE NO.	CHANGE INDEX DURING FORMAL ISSUE							REASON OF LATEST CHANGE
	FIRST ISSUE	SECOND ISSUE	THIRTH ISSUE	FOURTH ISSUE	FIFTH ISSUE	SIXTH ISSUE		
	REV.00	REV.01	REV.02	REV.03	REV.04	REV.05		
1	X							
2	X							
3	X							
4	X							
5	X							
6	X							
7	X							
8	X							
9	X							
10	X							
11	X							
12	X							
13	X							
14	X							
15	X							
16	X							
17	X							
18	X							
19	X							
20	X							
21	X							
22	X							
23	X							
24	X							
25	X							
26	X							
27	X							
28	X							
29	X							
30	X							
31	X							
32	X							
33	X							
34	X							
35	X							
36	X							
37	X							
38	X							
39	X							
60	X							

MT - LIFTING
LUGS

Doc Ref : MT 19108
 Revision : 1
 Date : 08-03-2022
 Title : Magnetic testing procedure
 Client : Airpack Nederland B.V.

MAGNETIC TESTING PROCEDURE

Client : Airpack Nederland B.V.

Purpose of the examination : Magnetic particle inspection of welds.

Method : According to AWS D1.1 / D1.1M: 2015 (ASTM E709)

Issued by : Applus RTD BUA NL

Development – Revisions					
Revision no.	Prepared by	Date	Approved by	Date	Amendment details
1	Vincent Spieringhs	08-03-2022			Indicated in margin
0	Kevin Cocquyt	20-12-2019	Vincent Spieringhs	20-12-2019	

 VMJ Spieringhs MT3 ISO 9712/ N61954 2022.03.08 14:17:52 +01'00'					
		Date	08-03-2022	Date	

Address
 Delftweg 144, 3046 NC Rotterdam
 P.O. Box 10065, 3004 AB Rotterdam
 The Netherlands
 www.ApplusRTD.com

This publication is the intellectual property of Applus+ RTD and may not be used in whole or in part for any purpose other than the business of Applus+ RTD and may not be used for the business of the recipient and may not be passed to any other person without the permission of Applus+ RTD.

Contents

1	Scope	3
2	Referenced documents	3
2.1	<i>Applus+ RTD documents</i>	3
2.2	<i>Codes and standards</i>	3
2.3	<i>Abbreviations</i>	3
3	General requirements	4
3.1	<i>Personnel qualifications</i>	4
3.2	<i>Safety precautions</i>	4
3.3	<i>Surface preparation</i>	4
3.4	<i>Surface temperature</i>	4
3.5	<i>Identification and datum position</i>	5
3.6	<i>Viewing conditions</i>	5
4	Equipment and consumables	5
4.1	<i>Yokes</i>	5
4.2	<i>Light meters</i>	5
4.3	<i>Examination consumables</i>	5
5	Examination	7
5.1	<i>Examination method</i>	7
5.2	<i>Direction of magnetization</i>	7
5.3	<i>Extent of examination</i>	7
5.4	<i>Demagnetization</i>	7
5.5	<i>Post examination cleaning</i>	7
6	Evaluation of indications	8
7	Acceptance standard	8
7.1	<i>Choice of acceptance criteria</i>	8
7.2	<i>Acceptance criteria</i>	9
8	Report	10

1 Scope

This procedure describes the method and acceptance criteria to be used for magnetic testing on structural steel skids with AC yoke magnetisation. To be performed in conformity with the requirements of;

- AWS D1.1/D1.1M:2015 (ASTM E709)

2 Referenced documents

2.1 *Applus+ RTD documents*

NL-10	Written practice for the Training, Qualification, Certification and Authorization of NDT Personnel
CP 31201	Verification procedure for electric magnetic yokes
CP 31203	Verification procedure for magnetic particle suspensions
CP 31210	Verification procedure of light intensity meters

2.2 *Codes and standards*

ISO 9712	Qualification and certification of NDT personnel
SNT TC 1A: 2016	Personnel qualification and certification in NDT
AWS D1.1/D1.1M:2015 (ASTM E709)	Magnetic particle Examination
AWS D1.1/D1.1M:2015	Acceptance standard for magnetic particle examination

2.3 *Abbreviations*

AC	Alternating Current
HSE	Health Safety and Environment
kg	kilogram
MT	Magnetic Testing
NDE	Non Destructive Examination
CJP	Complete Joint Penetration
°C	Temperature in degree Celsius
mm	Millimetre
<	Less than
≥	Greater than or equal to
CJP	Complete joint penetration
NA	Not applicable

3 General requirements

3.1 Personnel qualifications

NDE - personnel shall be qualified and certified in accordance with the valid version of Applus+ RTD written practice, which is in conformity with the recommended practice SNT-TC-1A and ISO 9712, level MT 2 as minimum.

Shall have passed an eyesight examination within the past 12 months, according the ISO 9712 section 7.4 or equivalent.

3.2 Safety precautions

All applicable HSE laws and regulations and the HSE rules of our customers shall be observed at all times. Furthermore Applus+ RTD develops its own HSE rules.

In case of conflict between rules and regulations, the strictest will prevail.
Special consideration shall be given to:

- inflammable and/or volatile materials;
- contrast paint and aerosols as used in magnetic testing;
- Extra attention at magnetic testing on hot objects > 50°C.

Use of safety gloves and eye protection is recommended.

Note:

The vapors from the consumables may be hazardous. Proper ventilation shall be provided in the case of testing being performed in a confined space. At no time during examination, shall there be exposure to any naked flames or sparks due to the flammable nature of the materials.

The use of aerosol containers and dry powders in confined spaces is dangerous and therefore it is only permitted in accordance with the Applus+ RTD safety pocketbook "working in confined spaces".

3.3 Surface preparation

Prior to the magnetic examination the surface or weld surface plus at least 25 mm on both sides of the weld, shall be dry and free of dirt, grease, coating, preserving, scale, welding flux, weld spatter, oil and other matter, that could obscure surface openings or otherwise interfere with the examination.

Typical cleaning agents which may be used are detergents, organic solvents, de-scaling solutions, and paint removers. Degreasing and ultrasonic cleaning methods may also be used.

Surface preparation by grinding or machining may be necessary where surface irregularities could mask indications or produce false indications.

3.4 Surface temperature

The surface temperature of the part to be examined (only for the "wet method") shall be within the temperature range limitations set by the manufacturer of the particles.

3.4.1 High temperature

If the (surface) temperature is > 50°C suitable consumables shall be used.

3.5 Identification and datum position

The welds shall be identified in accordance with the client's requirements.

The marking of flaw indications on the tested component shall be considered necessary as the resultant indications found at the time of inspection cannot be considered permanent. The position of flaws shall be marked on the tested component by a method that will not affect the use of the component or prejudice any subsequent testing.

3.6 Viewing conditions

At all times during the examination with the non-fluorescent method, the light intensity at the surface to be examined shall be 1000 lux. as a minimum.

4 Equipment and consumables

4.1 Yokes

An AC magnet Yoke shall be used.

The lifting power shall be checked prior to examination, and shall be 4.5 kg as minimum at the maximum pole spacing that will be used.

The verification of the yoke shall be done once a year or whenever the yoke has been damaged or repaired, in accordance with procedure Applus+ RTD CP 31201.

A field indicator (e.g. Berthold field indicator) may be used, if necessary, to determine the field direction.

4.2 Light meters

Light meters shall be calibrated at least once a year (12 month period +/- 2 weeks) or whenever the meter has been repaired. If meters have not been in use for one year or more, calibration shall be done before being used.

The light meters have to be verified, according to Applus+ RTD verification procedure CP 31210.

4.3 Examination consumables

The examination consumables to be used must provide sufficient contrast with the surface to be examined. The examination medium shall be supplied by Applus+ RTD.

The preferred examination consumables are given on page 6; other products may be used after approval by Applus+ RTD level 3 specialist.

4.3.1 Black particles (wet method)

The magnetic particles, black and fluorescent, to be used in the examination shall meet the following requirements:

- Are oil or water suspended;
- The colour of the particles shall be such as to provide an adequate contrast with the surface being examined;
- The examination consumables shall be agitated (shaken) properly, as per manufacturers' recommendation, to ensure that the dispersion of particles is equal throughout the entire use of the containers contents.
- The test medium shall be applied by either flowing or spraying over the surface. The force of the application shall be such that weakly formed indications are not disturbed or removed.

Wet particles: MR Chemie:

<u>Type</u>	<u>Product</u>	<u>Temp. range</u>	<u>Suspension</u>
• MR 76 SAS	Magnetic testink (black)	+5° to +50°C	Oil based
• MR 221 GF	Magnetic testink (black)	+5° to +50°C	Water based

These wet particles have been tested by the manufacturer for conformity. Where necessary the examination medium will be tested in accordance with verification procedure Applus+ RTD CP 31203.

4.3.2 Contrast paint

If the contrast between the surface and the examination medium is too low, a very thin contrast paint layer shall be applied to the surface.

The preferred contrast paint is given below; other contrast paint may be used after approval by Applus+ RTD level 3 specialist.

<u>Type</u>	<u>Product</u>	<u>Temp. range</u>	<u>Suspension</u>
• MR 72	White contrast paint	+5° to +50°C	
• MR 721	White contrast paint	+5° to +50°C	Water based

5 Examination

5.1 Examination method

The magnetic particles used in an examination (wet or dry) shall be applied by the continuous method: The magnetizing current shall remain on while the examination medium is being applied and while excess of the examination medium will flow away, or the dry powder will be softly blown away. Following this, time shall be allowed for indications to form before removal of the magnetic field.

5.2 Direction of magnetization

To ensure detection of imperfections in all orientations, the area shall be magnetized in two directions approximately perpendicular to each other.

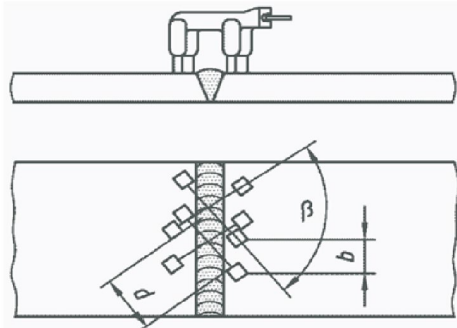

$$d = \geq 75, b = \leq 2d \text{ and } \beta = 90^\circ$$

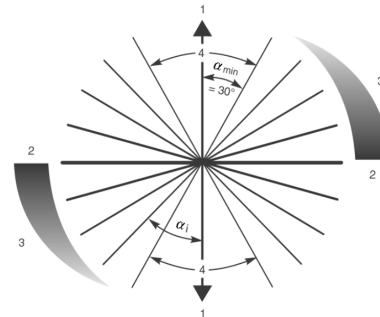

α = is the angle between the magnetic field and the direction of the imperfection
 α_{min} = is the minimum angle for imperfection detection.
 α_1 = is an example of imperfection orientation.
1 = magnetic field direction, 2 = optimum sensitivity,
3 = reducing sensitivity and 4 = insufficient sensitivity

5.3 Extent of examination

The examination has to be executed in such a manner that there is sufficient overlap to ensure that 100% examination has been executed.

5.4 Demagnetization

The examined areas shall not be demagnetized after examination.

After testing with AC current, residual magnetization will normally be low and generally there is no need for demagnetization of the tested object.

5.5 Post examination cleaning

The examined areas shall not be cleaned after examination.

6 Evaluation of indications

The evaluation of indications shall be done during the magnetization.

An indication of an imperfection may be larger than the real imperfection. However the size of the indication will be the basis for the evaluation.

A linear indication is an indication (piping porosity), of which the length is larger than 3 times the width.

A rounded (non-linear) indication (porosity) is an indication of circular- and/or elliptical shape with a length equal to or less than 3 times its width.

Note:

Not all of the indications are relevant, because excessive surface roughness, etc. may cause similar indications. Any questionable indications shall be re-examined, possibly after surface improvement, to determine whether or not it is relevant.

7 Acceptance standard

7.1 Choice of acceptance criteria

The client shall provide the load condition and load direction before examination.

Required info:

Statically loaded or cyclically loaded.

Tensile stress during any load condition: Yes or No.

When the load condition is unknown the used acceptance shall be cyclically loaded with tensile stress.

7.2 Acceptance criteria

Acceptance according AWS D1.1: 2015 Claus 6. Table 6.1 and Clause 9, Table 9.6.

Discontinuity Category and Inspection Criteria	Table 6.1		Table 9.6
	Statically Loaded Nontubular Connections	Cyclically Loaded Nontubular Connections	Tubular Connections (All Loads)
1) Crack Prohibition <i>Any crack shall be unacceptable, regardless of size or location.</i>	x	x	x
(2) Weld/Base Metal Fusion <i>Complete fusion shall exist between adjacent layers of weld metal and between weld metal and base metal.</i>	x	x	x
(7) Undercut <i>A) For material less than 1 in [25 mm] thick, undercut shall not exceed 1/32 in [1 mm], with the following exception: undercut shall not exceed 1/16 in [2 mm] for any accumulated length up to 2 in [50 mm] in any 12 in [300 mm]. For material equal to or greater than 1 in [25 mm] thick, undercut shall not exceed 1/16 in [2 mm] for any length of weld.</i>	x	NA	NA
<i>(B) In primary members, undercut shall be no more than 0.01 in [0.25 mm] deep when the weld is transverse to tensile stress under any design loading condition. Undercut shall be no more than 1/32 in [1 mm] deep for all other cases.</i>	NA	x	x
(8) Porosity <i>(A) CJP groove welds in butt joints transverse to the direction of computed tensile stress shall have no visible piping porosity. For all other groove welds and for fillet welds, the sum of the visible piping porosity 1/32 in [1 mm] or greater in diameter shall not exceed 3/8 in [10 mm] in any linear inch of weld and shall not exceed 3/4 in [20 mm] in any 12 in [300 mm] length of weld.</i>	x	NA	NA
<i>(B) The frequency of piping porosity in fillet welds shall not exceed one in each 4 in [100 mm] of weld length and the maximum diameter shall not exceed 3/32 in [2.5 mm]. Exception: for fillet welds connecting stiffeners to web, the sum of the diameters of piping porosity shall not exceed 3/8 in [10 mm] in any linear inch of weld and shall not exceed 3/4 in [20 mm] in any 12 in [300 mm] length of weld.</i>	NA	x	x
<i>(C) CJP groove welds in butt joints transverse to the direction of computed tensile stress shall have no piping porosity. For all other groove welds, the frequency of piping porosity shall not exceed one in 4 in [100 mm] of length and the maximum diameter shall not exceed 3/32 in [2.5 mm].</i>	NA	x	x

Discontinuities 3, 4, 5 and 6 shall only be subject to visual inspection.

Discontinuities 2, 7 and 8 shall only be evaluated on length in case of an MPI indication and shall not be evaluated on other dimensions.

X shall be evaluated

NA shall not be evaluated

8 Report

For each magnetic examination carried out a report shall be written. Each report shall contain the following information as minimum:

- Procedure number and revision;
- Examination standard, acceptance standard;
- Client;
- Date of examination;
- Equipment used and type of current;
- Magnetic particles used incl. batch numbers (wet or dry);
- Object data and examined parts;
 - base material;
 - extent of examination
 - in case of welds type of weld, welding process and filler material;
 - heat treatment (if applicable);
 - thickness;
 - temperature of the object;
- Viewing conditions(light intensity);
- Drawing or record of all indications exceeding the acceptance standard;
 - All relevant indications shall be reported with as minimum the type, location and extent (length, diameter or aligned);
- Name operator(s) qualification and signature operator(s) who performed examination.

RT - PIPING

Doc Ref : RT 21002
 Revision : 28
 Date : 17-12-2019
 Title : Radiographic examination
 Type : Standard procedure

RADIOGRAPHIC EXAMINATION PROCEDURE

Procedure for:

Radiographic Examination of fusion welded welds in metallic materials up to 75 mm.

To be performed in conformity with the requirements of:

- **ASME BPV Code Section V, article 2, edition 2019**

Development – Revisions					
Revision No.	Prepared By	Date	Approved By	Date	Amendment Details
28	M. Vondenhoff	17-12-2019	T.Cornelissen	17-12-2019	Complete revised and updated to ASME BPVC code V, 2019.
27		12-12-2017			
0		01-08-1991			
 Applus+ RTD L3 MT/PT/UT M. Vondenhoff		 Applus+ RTD L3 MT/PT/RT/UT T.A.F. Cornelissen		Digitally signed by Theo Cornelissen Date: 2020.01.07 14:42:29 +01'00'	
Date:	17-12-2019	Date:	17-12-2019	Date:	

Address
 Delftweg 144, 3046 NC Rotterdam
 P.O. Box 10065, 3004 AB Rotterdam
 The Netherlands
www.ApplusRTD.com

This publication is the intellectual property of Applus+ RTD and may not be used in whole or in part for any purpose other than the business of Applus+ RTD and may not be used for the business of the recipient and may not be passed to any other person without the permission of Applus+ RTD.

Contents

1	Scope	3
2	References and abbreviations	3
2.1	<i>Applus+ RTD documents</i>	3
2.2	<i>Codes and standards</i>	3
2.3	<i>Abbreviations</i>	3
3	Safety	4
3.1	<i>Radiation Safety</i>	4
4	Personnel qualifications	4
5	Equipment and materials	5
5.1	<i>Equipment</i>	5
5.2	<i>Films</i>	5
5.3	<i>Image Quality Indicator (IQI)</i>	5
5.4	<i>Densitometer</i>	6
5.5	<i>Facilities for viewing of radiographs</i>	7
6	Examination	7
6.1	<i>Choice of examination energy / radioactive source</i>	7
6.2	<i>Surface preparations</i>	7
6.3	<i>Weld reinforcement</i>	7
6.4	<i>Backscatter radiation check</i>	7
6.5	<i>System of identification</i>	8
6.6	<i>Monitoring density limitations of radiographs</i>	8
6.7	<i>Radiographic technique</i>	8
6.8	<i>Direction of radiation</i>	9
6.9	<i>Geometric un-sharpness</i>	9
6.10	<i>Location markers</i>	9
6.11	<i>IQI selection</i>	10
6.12	<i>IQI placement for welds</i>	10
6.13	<i>Number of IQIs</i>	11
6.14	<i>Shims under hole type IQIs</i>	11
6.15	<i>Number of exposures for circumferential welds</i>	11
7	Evaluation of the radiograph	11
7.1	<i>Quality of radiographs</i>	11
7.2	<i>Radiographic density</i>	12
7.3	<i>IQI sensitivity</i>	12
7.4	<i>Excessive backscatter</i>	12
7.5	<i>Acceptance criteria radiograph</i>	12
8	Report	13
8.1	<i>Radiograph review form.</i>	13
	Attachment A Exposure arrangements	14
	Attachment B Number of exposures table (guideline)	16
	Attachment C Weld reinforcement and Weld categories	18
	Attachment D Location markers	19
	Attachment E IQI wire / hole number, thickness and type	20

1 Scope

This procedure describes the method of examination of fusion welded welds in metallic materials up to 75 mm according to:

- ASME BPV Code Section V, article 2 edition 2019.

2 References and abbreviations

2.1 *Applus+ RTD documents*

- NL-10 Written practice for the Training, Qualification, Certification and Authorization of NDT Personnel.
- CP 31003 Verification procedure for film densitometers.
- CP 31014 Verification procedure for illuminators used for industrial radiographs.

2.2 *Codes and standards*

- ASME BPVC Section V ASME Boiler and Pressure Vessel Code, an International Code, Non-destructive Examination.
- ASTM E-747 Standard Guide for Design, Manufacturing and Material Grouping Classification of Wire IQI used for Radiology
- ASTM E-999 Standard Guide for Controlling the Quality of Industrial Radiographic Film Processing
- ASTM E-1025 Standard Practice for Design, Manufacture, and Material Grouping of Hole-Type IQI used for Radiology
- ASTM E1165 Standard Test Method for Measurement of Focal Spots of Industrial X-Ray Tubes by Pinhole Imaging
- ISO 19232-1 Non-destructive testing — Image quality of radiographs — Part 1: Determination of the image quality value using wire-type image quality indicators.
- ISO 9712 Qualification and certification of NDT personnel.
- SNT-TC-1a Personnel qualification and certification in non-destructive testing.
- CI 5A/5B Ionizing radiation course.

2.3 *Abbreviations*

b	Object to film distance.
D	Distance from source of radiation to weld or object being radiographed.
D _e	Nominal external diameter of the pipe
d	Distance from source side of weld or object being radiographed to the film.
DWE	Double Wall Exposure.
DWV	Double Wall Viewing.
F	Source size: the maximum projected dimension of the radiating source (or effective focal spot) in the plane perpendicular to the distance D from the weld or object being radiographed.
f _{min}	Minimum source to object distance.
HSE	Health Safety and Environment.
IQI	Image quality indicator.
kV	kilo Voltage.
mA	milli Amperage.
NDT	Non Destructive Testing.
RT	Radiographic Testing.
S	Radiation source.
SWE	Single Wall Exposure.
SWV	Single Wall Viewing.

Doc Ref : RT 21002
Revision : 28
Date : 17-12-2019
Title : Radiographic examination
Type : Standard procedure

t Nominal Wall thickness.
U_g Geometric unsharpness.
w Penetrated Thickness.

3 Safety

All applicable laws and regulations on HSE and the HSE rule of our customers shall be observed at all times. Furthermore Applus+ RTD develops its own HSE rules. In case of conflict between rules and regulations, the strictest will prevail.

Special consideration shall be given to:

- Inflammable and/or volatile materials.
- Radiation safety.
- Use of safety gloves on hot objects is recommended.

3.1 Radiation Safety

Exposure of any part of the human body to X-ray or γ -ray can be highly injurious to health. Wherever X-ray or γ -ray equipment is in use, adequate precautions shall be taken to protect the radiographer and any other person in the vicinity.

Established safety precautions shall be strictly observed and everyone working with ionising radiation shall be certified with a radiation safety course.

For radiation monitoring only calibrated dose rate meters shall be used.

Maximum radiation at the border marked with radiation signs of the radiation working shall be in accordance with local regulations.

At least one of the crew operators shall have followed and passed a radiation safety course like CI 5A/5B.

4 Personnel qualifications

NDE personnel shall be qualified and certified in accordance with the valid version of Applus+ RTD Written Practice, which is in conformity with ISO 9712 and SNT-TC-1a.

The radiographic examination shall be performed by personnel qualified with level RT 2 as minimum.

Personnel level 1 or instructed trainee shall be assigned to NDE under the supervision of personnel level 2 as minimum only.

5 Equipment and materials

5.1 Equipment

For X-ray:

Directional energy range up to 300 kV.

Panoramic energy range up to 300 kV.

For examination of aluminium welds an X-ray tube with Beryllium window shall be used.

For γ -ray:

Iridium 192 (Ir192).

Selenium 75 (Se75).

5.2 Films

The films to be used shall be class 2 (e.g. Agfa D7) or better.

The films must be free of defects that disturb the evaluation of the results of the radiographic examination.

The following disturbances are also unacceptable:

- Repairs carried out on films due to improper treatment or development.
- Scratches and contamination.
- Static discharge.
- Indications of defect screens or carrier errors.

5.2.1 Developing of films

Developing of films should be done automatically or manual in accordance to SE-999 and chemicals of the manufacturers developing machine conditions.

Tenability of the radiographs shall be at least 10 years. This can be verified with a Thiosulphate test.

5.2.2 Storage of films

All unexposed films shall be stored in a clean, dry place where the conditions will not detrimentally affect the emulsion. If any question arises about the condition of the unexposed film, sheets from the front and back of each package or a length of film equal to the circumference of each original roll shall be processed in the normal manner without exposure to light or radiation.

If the processed film shows fog, the entire box or roll from which the test film was removed shall be discarded, unless additional tests prove that the density of the remaining film is less than 0.3.

5.2.3 Screens

Ready pack films without lead screen shall be used when applied energy is below 100 kV.

Ready pack films with lead screens 0.027 mm thickness on front and back side of the film shall be used when applied energy is over 100 kV.

5.3 Image Quality Indicator (IQI)

IQIs shall be either the wire type or hole type. Wire-type IQIs shall be manufactured and identified in accordance with the requirements as per ASME BPVC V SE-747, except that the largest wire number or the identity number may be omitted. Hole-type IQIs shall be manufactured and identified in accordance with the requirements as per ASME BPVC V SE-1025.

ASME BPVC V standard IQIs shall consist of those in Table T-233.2 for wire type and those in Table T-233.1 for hole type (refer to Attachment E: IQI-wire / hole number).

Alternate IQIs (e.g. ISO 19232-1) are acceptable if the sensitivity is at least the thinnest required visible wire/hole as described in the ASME BPVC V article 2, as shown in table 1: ASME and ISO material groups of this procedure.

In addition, any group IQI may be used for any material with a higher group number provided the applicable quality level is maintained.

Table 1: ASME and ISO material groups				
ASME BPVC V material group		IQI material	Examined material	Equivalent IQI ISO 19232-1
Light materials	01	Titanium	Titanium and alloys of which Titanium is the predominant alloying constituent	EN - TI
	02	Aluminium	Aluminium and alloys of which Aluminium is the predominant alloying constituent	EN - AL
Heavy materials	1	Carbon steel or Type 300 series Stainless steel	Carbon steel, low-alloy steels, stainless steels, and manganese-nickel-aluminium bronze (Superston).	EN - FE
	2	Aluminium Bronze (Alloy No. 623 of Specification B150M) or equivalent, or Nickel-Aluminium Bronze (Alloy No. 630 of Specification B150M) or equivalent	Aluminium Bronzes and all Nickel-Aluminium Bronzes	EN - CU
	3	Nickel-chromium-iron alloy (UNS No. N06600) (Inconel)	Nickel-chromium-iron alloy and 18 % nickel-maraging steel	EN - CU
	4	70 to 30 nickel-Copper alloy (Monel) (Class A or B of Specification B164) or equivalent, or 70 to 30 Copper-Nickel alloy (Alloy G of Specification B161) or equivalent	Nickel, copper, all nickel-copper series, or copper-nickel series of alloys, and all brasses (copper-zinc alloys). Group 4 IQI's may include the leaded brasses since leaded brass increases in attenuation with increase in lead content.	EN - CU
	5	Tin bronze (Alloy D of Specification B139/B139M).	Tin bronzes including gun-metal and valve bronze, or leaded-tin bronze of higher lead content than valve bronze. Group 5 IQI's may include bronze of higher lead content since leaded bronze increases in attenuation with increase in lead content. This would be equivalent to using a lower group IQI.	EN - CU
In addition, any group IQI may be used for any material with a higher group number provided the applicable quality level is maintained				

5.4 Densitometer

A densitometer with valid verification according Applus+ RTD verification procedure CP-31003 shall be used.

5.5 Facilities for viewing of radiographs

The proper assessment of image quality and accurate reporting on the diagnostic information of the radiographs shall be achieved by:

- The maximum density of the film assessed shall never exceed the light intensity incident of the viewer.
- The film viewer and lamps used shall be acceptable according Applus+ RTD verification procedure CP 31014.
- No light sources with a strength > 50 lux shall be visible when assessing the radiograph, to avoid dazzling.
- Means for magnifying details in the displayed radiographic image should be available. The magnifying glass shall be max. 10x.
- The ambient light intensity measured on the film viewer (with the film viewer off) shall be ≤ 20 lux.

6 Examination

6.1 Choice of examination energy / radioactive source

The radiation energy employed for any radiographic technique shall achieve the density and IQI image requirements.

6.1.1 Examination with γ -ray sources.

Except as provided in the special conditions below, the recommended minimum penetrated thickness for which radioactive isotopes will be used as follows:

- For Ir192 applicable for penetrated wall thickness 20 mm till 100 mm.
- For Se75 applicable for penetrated wall thickness 10 mm till 40 mm.

When it is not practical to perform radiography within the limitations outlined above, the procedure shall be proven satisfactory by actual demonstration of IQI image requirements on the required thickness of the material radiographed.

6.2 Surface preparations

The weld ripples or weld surface irregularities on both the inside (where accessible) and outside shall be removed by any suitable process to such a degree that the image of surface irregularities cannot mask or be confused with the image of any discontinuity on the resulting radiograph.

6.3 Weld reinforcement

As stated in ASME BPVC Section VIII division 1, UW-35 simply stated the following.

If there is a question regarding the surface condition of the weld when interpreting a radiographic film, the film shall be compared to the actual weld surface for determination of acceptability.

The thickness of the weld reinforcement on each face shall be not exceeding the following, refer to Attachmend C - Weld reinforment.

6.4 Backscatter radiation check

A lead symbol "B", with minimum dimensions of 11 mm in height and 1.5 mm in thickness, shall be attached to the back of each pre packed film during each exposure to determine if backscatter radiation is exposing the film.

The lead symbol "B" shall be placed in a location so that it would appear within an area on the radiograph that meets the density requirement.

6.5 System of identification

A system of identification shall be used to produce permanent identification on the radiograph traceable to:

- The contract.
- Component.
- Weld or weld seam or Part numbers.
- Date.

On clients request the following items can amended to the radiograph:

- The manufacturer's or stamp holder's symbol or name.
- NDT contractor's name or symbol.

This identification system does require that the information which is not appearing as radiographic image shall be recorded in another permanent way. In all cases, this information shall not obscure the area of interest.

6.5.1 Repair identification

Radiographs of repairs shall be identified by the letter R and may include -1, -2 etc. for the number of repairs or as otherwise agreed.

6.6 Monitoring density limitations of radiographs

A calibrated densitometer shall be used for measuring film density (see paragraph 5.4).

6.7 Radiographic technique

A single-wall exposure technique shall be used for radiography whenever practical.

When it is not practical to use a single-wall technique, a double-wall technique may be used. For exposure arrangements see Attachement A: Exposure arrangements.

6.7.1 Single-wall technique.

In the single-wall technique, the radiation passes through only one wall of the weld (material), which is viewed for acceptance on the radiograph.

6.7.2 Double-wall technique.

When it is not practical to use a single-wall technique, one of the following double-wall techniques shall be used.

(a) Single-wall viewing. For materials and for welds in components, a technique may be used in which the radiation passes through two walls and only the weld (material) on the film-side wall is viewed for acceptance on the radiograph. When complete coverage is required for circumferential welds (materials), a minimum of three exposures taken 120° to each other shall be made.

(b) Double-wall viewing. For materials and for welds in components 89 mm or less in nominal outside diameter, a technique may be used in which the radiation passes through two walls and the weld (material) in both walls is viewed for acceptance on the same radiograph.

For double-wall viewing, only a source-side IQI shall be used.

(1) For welds, the radiation beam may be offset from the plane of the weld at an angle sufficient to separate the images of the source-side and film-side portions of the weld so that there is no overlap of the areas to be interpreted. When complete coverage is required, a minimum of two exposures taken 90 degree to each other shall be made for each joint.

(2) As an alternative, the weld may be radiographed with the radiation beam positioned so that the images of both walls are superimposed. When complete coverage is required, a minimum of three exposures taken at either 60° or 120° to each other shall be made for each joint.

(3) Additional exposures shall be made if the required radiographic coverage cannot be obtained using the minimum number of exposures indicated in (1) or (2) above.

6.8 *Direction of radiation*

The direction of the central beam of radiation should be centred on the area of interest whenever practical.

6.9 *Geometric un-sharpness*

Geometric unsharpness of the radiograph shall be determined in accordance with:

$$U_g = \frac{Fd}{D}$$

Geometric unsharpness of the radiograph shall not exceed:

- 0.51 mm for wall thickness under 50 mm.
- 0.76 mm for wall thickness from 50 through 75 mm.

6.10 *Location markers*

Location markers or measure tape markers (max. interval 50mm) shall be placed on the part, and shall appear as radiographic images on the film. Their locations or "0" point shall be permanently marked on the surface of the part being radiographed or on a map, in a manner that the area of interest on the radiograph is accurately traceable to its location and provide evidence on the radiograph that the required coverage of the region being examined has been obtained.

Location markers shall be placed as follows according to Attachment D - location markers.

6.10.1 *Single-wall viewing*

(a) *Source side markers* Location markers shall be placed on the source side when radiographing the following:

1. Flat bottom components or longitudinal joints in cylindrical or conical components.
2. Curved or spherical components whose concave side is toward the source and when the source to material distance is less than the inside radius of the component.
3. Curved or spherical components whose convex side is toward the source.

(b) *Film side markers* Location markers shall be placed on the film side when radiographing either curved or spherical components whose concave side is toward the source and when the source to material distance is equal to or greater than the inside radius.

6.10.2 *Double-wall viewing method*

For double-wall viewing at least one location marker shall be placed on the source side surface adjacent to the weld (or on the material in the area of interest) for each radiograph.

Note:

For material and welds in components ≤ 89mm in nominal outside diameter only a source side IQI shall be used.

6.10.3 Mapping the placement of location markers

When inaccessibility or other limitations prevent the placement of markers as stipulated before dimensioned map of the actual marker placement shall accompany the radiographs and shall show that full coverage has been obtained.

6.11 IQI selection

IQI(s) shall be selected from either the same alloy material group or grade, or from a group with less radiation absorption than the material being radiographed. The designated hole or essential wire shall be as specified in the table below.

A smaller hole or a thinner wire than listed for each range may be used, provided equivalent penetrameter sensitivity and all other requirements for radiography are met.

The IQI selection is based on the nominal (drawing size) single wall thickness plus the estimated weld reinforcement (see table 2: IQI selection) not to exceed the maximum permitted by the reference Code Section. The actual measurement of the weld reinforcement is not required.

Backing rings or strips shall not be considered as part of the thickness in IQI selection.

Required sensitivity for hole-type IQI is the 2T-hole and for wire-type IQI is the essential wire number see table IQI selection.

Table 2: IQI selection						
Single Wall Material Thickness Range plus estimated weld reinforcement [mm]	Source Side			Film Side		
	Essential EN/ISO wire	Essential ASTM wire	Plate No. 2T hole	Essential EN/ISO wire	Essential ASTM wire	Plate No. 2T hole
Up to 6.4 incl.	13	5	12	14	4	10
Over 6.4 through 9.5	12	6	15	13	5	12
Over 9.5 through 12.7	11	7	17	12	6	15
Over 12.7 through 19.0	10	8	20	11	7	17
Over 19.0 through 25.4	9	9	25	10	8	20
Over 25.4 through 38.1	8	10	30	9	9	25
Over 38.1 through 50.8	7	11	35	8	10	30
Over 50.8 through 63.5	6	12	40	7	11	35
Over 63.5 through 75	5	13	50	6	12	40

Note:

On request where IQI(s) are placed on the film side, the technique shall be qualified by demonstrating the required sensitivity of a source side IQI on a test piece.

6.12 IQI placement for welds

The IQI identification and the letter "F" if used shall not in the area of interest.

6.12.1 IQI location for welds

The hole type IQI(s) will be placed adjacent to or on the weld. The wire type IQI(s) will be placed on the weld so that the length of the wires is across the length of the weld.

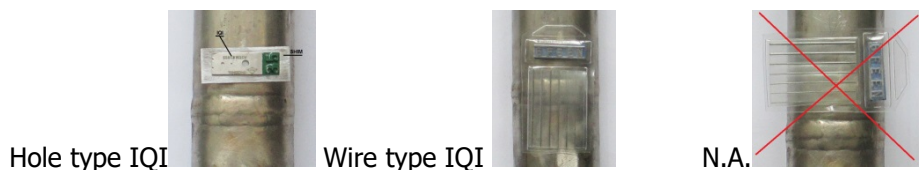

6.12.2 *Source side IQI(s)*

The IQI(s) shall be placed on the source side of the part being examined, except in the condition as described below.

6.12.3 *Film side IQI(s)*

For diameter > 89 mm and where inaccessibility prevents hand placing the IQI(s) on the source side, it shall be placed on the film side in contact with the part being examined. A lead letter "F" at least as high as the IQI identification number(s) shall be placed adjacent to or on the IQI(s).

6.13 *Number of IQIs*

For welds where one or more films are used for an exposure, at least one IQI image shall appear on each radiograph except for cylindrical welds where the source is placed on the axis of the object and one or more film holders are used for a single exposure of a complete circumference three IQIs shall be spaced approximately 120° apart. Where sections of longitudinal welds adjoining the circumferential weld are radiographed simultaneously, an additional IQI shall be placed on each longitudinal weld at the end of each section most remote from the junction with the circumferential weld being radiographed.

6.14 *Shims under hole type IQIs*

A shim of material radiographically similar to the weld metal shall be placed between the part and the hole type IQI, if needed, so that the radiographic density throughout the area of interest is no more than minus 15% (lighter than) the radiographic density through the IQI. The shim dimensions shall exceed the IQI dimensions such that the outline of at least three sides of the IQI image shall be visible on the radiograph.

6.15 *Number of exposures for circumferential welds*

An adequate number of exposures shall be made to demonstrate that the required coverage has been obtained.

Number of exposures (as shown in Attachment D) can be used as a guide line, for x-rays and gamma-rays. (exposure arrangements E + D).

For diameters ≤ 89mm, the DW-DI (Double wall-Double image) technique F and G shall be performed.

7 Evaluation of the radiograph

7.1 Quality of radiographs

All radiographs shall be free from mechanical, chemical, or other blemishes to the extent that they cannot mask or be confused with the image of any discontinuity in the area of interest of the object being radiographed.

Such blemishes include, but are not limited to:

- Fogging.
- Processing defects such as streaks, watermarks, or chemical stains.
- Scratches, finger marks, crimps, dirtiness, static marks, smudges, or tears.
- False indications due to defective screens.

7.2 Radiographic density

7.2.1 Density limitations

The transmitted film density through the radiographic image of the body of the designated IQI and the area of interest shall be 1.8 minimum for single film viewing for radiographs made with an X-ray source and 2.0 minimum for radiographs made with a gamma ray source.

The maximum density shall be 4.0 for single film viewing. A tolerance of 0.05 in density is allowed for variations between densitometer readings.

7.2.2 Density variation

If the density of the radiograph anywhere through the area of interest varies more than minus 15% or plus 30% from the density through the body of the hole type IQI or adjacent to the designated wire of the wire IQI, within the minimum/maximum allowable density ranges specified above, then an additional IQI shall be used for each exceptional area or areas and the radiograph retaken. When calculating the allowable variation in density, the calculation may be rounded to the nearest 0.1 within the range specified above.

When shims are used the plus 30% density restriction may be exceeded and the minimum mentioned above does not apply, provided the required IQI sensitivity is met.

7.3 IQI sensitivity

Radiography shall be performed with a technique of sufficient sensitivity to display the designated hole type IQI image and the essential hole or essential wire of the wire type IQI. The radiographs shall also display the IQI identifying numbers and letters. For wire-type IQIs, the essential wire shall be visible within the area of interest representing the thickness used for determining the essential wire, inclusive of the allowable density variations.

7.4 Excessive backscatter

If a light image of the "B", specified in 6.4, appears on a darker background of the radiograph, protection from backscatter is insufficient and the radiograph shall be considered unacceptable. A dark image of the "B" on a lighter background will be acceptable if the image cannot be confused with a defect.

7.5 Acceptance criteria radiograph

Density X-ray 1.8 – 4.0 according paragraph to 7.2.

Density Y-ray 2.0 – 4.0 according paragraph to 7.2.

Required IQI visible in area of interest according paragraph to 6.11.

No excessive backscatter or light B according paragraph to 6.4.

Film identification, weld number, date, manufacture logo and object according paragraph to 6.5.

Text and measurement markers not in area of interest.

Number of films considering effective film length.

8 Report

For a proper interpretation of the radiographs, the report accompanying each group of radiographs shall contain, as a minimum, the following information:

- Procedure and revision number used.
- Identification to the contract, component and weld.
- Identification of exposure arrangement.
- Map of location marker placement, when applicable.
- Number of exposures.
- Isotope or applied X-ray kV.
- Effective focal spot sizes (F).
- Material type and thickness range, weld thickness and reinforcement.
- Source-to-object distance (D).
- Distance from source side of object to film (d).
- Film brand and designation.
- Number of films per cassette.
- Single- or double-wall exposure/viewing.
- Date of examination.
- Name and level personnel.

8.1 Radiograph review form.

The Manufacturer shall be responsible for the preparation of a radiograph review form. As a minimum, the following information shall be provided:

- A listing of each radiograph location.
- Evaluation and disposition of the weld(s) examined.
- Identification of the manufacturer's representative who performed the final acceptance of the radiographs (if applicable).
- Date of manufacturer's evaluation (if applicable).

Attachment A Exposure arrangements

**Figure A-210-1
Single-Wall Radiographic Techniques**

Pipe O.D.	Exposure Technique	Radiograph Viewing	Source-Weld-Film Arrangement		IQI		Location Marker Placement
			End View	Side View	Selection	Placement	
Any	Single-Wall T-271.1	Single-Wall	 <p>Exposure Arrangement — A</p>		T-276 and Table T-276	Source Side T-277.1(a)	Either Side T-275.3 T-275.1(c)
				Film Side T-277.1(b)			
Any	Single-Wall T-271.1	Single-Wall	 <p>Exposure Arrangement — B</p>		T-276 and Table T-276	Source Side T-277.1(a)	Film Side T-275.1 (b)(1)
				Film Side T-277.1(b)			
Any	Single-Wall T-271.1	Single-Wall	 <p>Exposure Arrangement — C</p>		T-276 and Table T-276	Source Side T-277.1(a)	Source Side T-275.1 (a)(3)
				Film Side T-277.1(b)			

Figure A-210-2
Double-Wall Radiographic Techniques

O.D.	Exposure Technique	Radiograph Viewing	Source-Weld-Film Arrangement		IQI		Location Marker Placement
			End View	Side View	Selection	Placement	
Any	Double-Wall: T-271.2(a) at Least 3 Exposures 120 deg to Each Other for Complete Coverage	Single-Wall	 <p>Exposure arrangement — D</p>		T-276 and Table T-276	Source Side T-277.1(a) Film Side T-277.1(b)	Film Side T-275.1(b) (1)
Any	Double-Wall: T-271.2(a) at least 3 Exposures 120 deg to Each Other for Complete Coverage	Single-Wall	 <p>Exposure arrangement — E</p>		T-276 and Table T-276	Source Side T-277.1(a) Film Side T-277.1(b)	Film Side T-275.1(b) (1)
3 1/2 in. (89 mm) or Less	Double-Wall T-271.2(b)(1) at Least 2 Exposures at 90 deg to Each Other for Complete Coverage	Double-Wall (Ellipse): Read Offset Source Side and Film Side Images	 <p>Exposure arrangement — F</p>		T-276 and Table T-276	Source Side T-277.1(a)	Either Side T-275.2
3 1/2 in. (89 mm) or Less	Double-Wall: T-271.2(b)(2) at Least 3 Exposures at 60 deg or 120 deg to Each Other for Complete Coverage	Double-Wall: Read Super-imposed Source Side and Film Side Images	 <p>Exposure arrangement — G</p>		T-276 and Table T-276	Source Side T-277.1(a)	Either Side T-275.2

Attachment B Number of exposures table (guideline)

The table 3 and 4 are a guideline for the number of exposures, the number of exposures shall be chosen based on the effective film length.

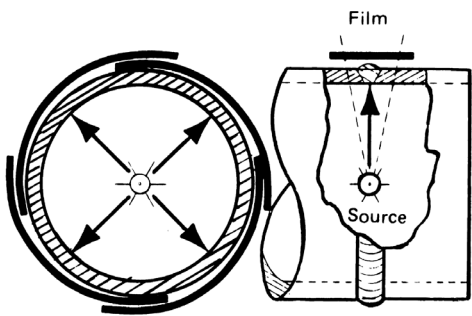
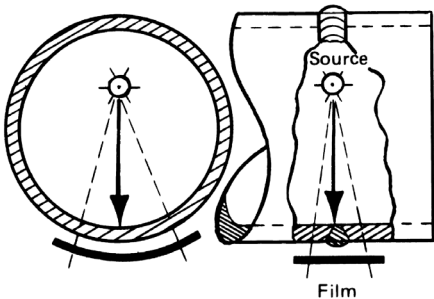
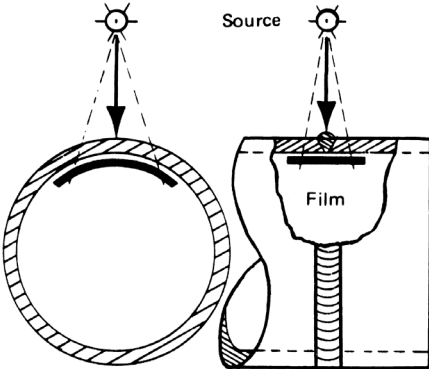
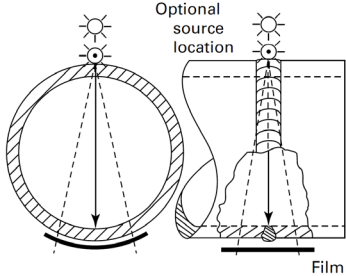
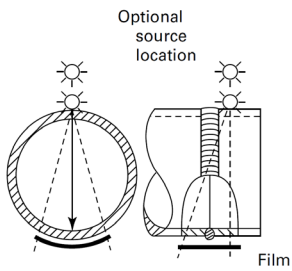
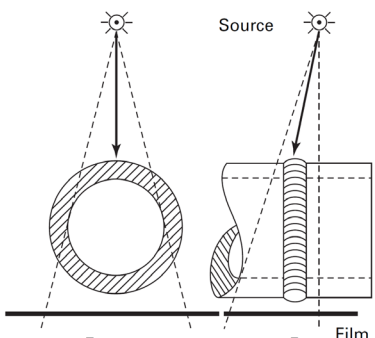
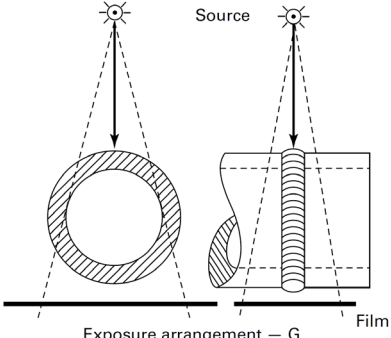
Table 3: X-Ray exposure guideline.

X-ray		Schedule																
Diameter		5s	10s	10	20	30	STD 40s	40	60	XS 80s	80	100	120	140	160	XXS	inch	
inch	mm																	
1/2	21,3	2/3	2/3	---	---	---	2/3	2/3	---	2/3	2/3	---	---	---	2/3	2/3	1/2	
3/4	26,7	2/3	2/3	---	---	---	2/3	2/3	---	2/3	2/3	---	---	---	2/3	3	3/4	
1	33,4	2/3	2/3	---	---	---	2/3	2/3	---	2/3	2/3	---	---	---	2/3	3	1	
1 1/4	42,2	2/3	2/3	---	---	---	2/3	2/3	---	2/3	2/3	---	---	---	2/3	3	1 1/4	
1 1/2	48,3	2/3	2/3	---	---	---	2/3	2/3	---	2/3	2/3	---	---	---	2/3	3	1 1/2	
2	60,3	2/3	2/3	---	---	---	2/3	2/3	---	2/3	2/3	---	---	---	3	3	2	
2 1/2	73,0	2/3	2/3	---	---	---	2/3	2/3	---	2/3	2/3	---	---	---	3	3	2 1/2	
3	88,9	2/3	2/3	---	---	---	2/3	2/3	---	2/3	2/3	---	---	---	3	3	3	
3 1/2	101,6	5	5	---	---	---	5	5	---	5	5	---	---	---	---	---	3 1/2	
4	114,3	5	5	---	---	---	5	5	---	5	5	---	5	---	5	6	4	
5	141,3	5	5	---	---	---	5	5	---	5	5	---	5	---	5	5	5	
6	168,3	5	5	---	---	---	5	5	---	5	5	---	5	---	5	5	6	
8	219,1	4	4	---	4	4	5	5	5	5	5	5	5	5	5	5	8	
10	273,1	4	4	---	4	4	4	4	4	4	4	4	4	4	4	4	10	
12	323,9	4	4	---	4	4	4	4	4	4	4	4	4	4	5	5	12	
14	355,6	4	4	4	4	4	4	4	4	4	4	4	4	4	4	5	14	
16	406,4	4	4	4	4	4	4	4	4	4	4	4	4	4	4	4	16	
18	457,2	4	4	4	4	4	4	4	4	4	4	4	4	4	4	4	18	
20	508,0	4	4	4	4	4	4	4	4	4	4	4	4	4	4	4	20	
22	558,8	---	---	4	4	4	4	---	4	4	4	4	4	4	4	---	22	
24	609,6	4	4	4	4	4	4	4	4	4	4	4	4	4	4	---	24	
26	660,4	---	---	4	4	---	4	---	---	4	---	---	---	---	---	---	26	
28	711,2	---	---	4	4	4	4	---	---	4	---	---	---	---	---	---	28	
30	762,0	---	---	4	4	4	4	---	---	4	---	---	---	---	---	---	30	
32	812,8	---	---	4	4	4	4	4	---	4	---	---	---	---	---	---	32	
34	863,8	---	---	4	4	4	4	4	---	4	---	---	---	---	---	---	34	
36	914,4	---	---	4	4	4	4	4	---	4	---	---	---	---	---	---	36	
42	1067,0	Wallthickness 8,74 up to including 25,4 mm					4				4							42
48	1219,0	Wallthickness 8,74 up to including 25,4 mm					4				4							48

Code 2/3 means: 2 exposures, the elliptical technique "F" at 90° to each other or
3 exposures, superimposed technique "G" at 60° or 120° to each other.

Doc Ref : RT 21002
Revision : 28
Date : 17-12-2019
Title : Radiographic examination
Type : Standard procedure

Table 4: Y-Ray exposure guideline

Se75 / Ir192		Schedule																
Diameter		5s	10s	10	20	30	STD 40s	40	60	XS 80s	80	100	120	140	160	XXS	inch	
inch	mm																	
1/2	21,3	2/3	2/3	---	---	---	2/3	2/3	---	2/3	2/3	---	---	---	2/3	2/3	1/2	
3/4	26,7	2/3	2/3	---	---	---	2/3	2/3	---	2/3	2/3	---	---	---	2/3	3	3/4	
1	33,4	2/3	2/3	---	---	---	2/3	2/3	---	2/3	2/3	---	---	---	2/3	3	1	
1 1/4	42,2	2/3	2/3	---	---	---	2/3	2/3	---	2/3	2/3	---	---	---	2/3	3	1 1/4	
1 1/2	48,3	2/3	2/3	---	---	---	2/3	2/3	---	2/3	2/3	---	---	---	2/3	3	1 1/2	
2	60,3	2/3	2/3	---	---	---	2/3	2/3	---	2/3	2/3	---	---	---	3	3	2	
2 1/2	73,0	2/3	2/3	---	---	---	2/3	2/3	---	2/3	2/3	---	---	---	3	3	2 1/2	
3	88,9	2/3	2/3	---	---	---	2/3	2/3	---	2/3	2/3	---	---	---	3	3	3	
3 1/2	101,6	3	3	---	---	---	3	3	---	4	4	---	---	---	---	---	3 1/2	
4	114,3	3	3	---	---	---	3	3	---	4	4	---	4	---	4	4	4	
5	141,3	3	3	---	---	---	3	3	---	3	3	---	4	---	4	4	5	
6	168,3	3	3	---	---	---	3	3	---	3	3	---	4	---	4	4	6	
8	219,1	3	3	---	3	3	3	3	3	3	3	3	4	4	4	4	8	
10	273,1	3	3	---	3	3	3	3	3	3	3	3	4	4	4	4	10	
12	323,9	3	3	---	3	3	3	3	3	3	3	3	4	4	4	4	12	
14	355,6	3	3	3	3	3	3	3	3	3	3	3	4	4	4	---	14	
16	406,4	3	3	3	3	3	3	3	3	3	3	3	4	4	4	---	16	
18	457,2	3	3	3	3	3	3	3	3	3	3	3	4	4	4	---	18	
20	508,0	3	3	3	3	3	3	3	3	3	3	3	4	4	4	---	20	
22	558,8	3	3	3	3	3	3	---	3	3	3	3	4	4	4	---	22	
24	609,6	3	3	3	3	3	3	3	3	3	3	3	4	4	4	---	24	
26	660,4	---	---	3	3	---	3	---	---	3	---	---	---	---	---	---	26	
28	711,2	---	---	3	3	3	3	---	---	3	---	---	---	---	---	---	28	
30	762,0	3	3	3	3	3	3	---	---	3	---	---	---	---	---	---	30	
32	812,8	---	---	3	3	3	3	3	---	3	---	---	---	---	---	---	32	
34	863,8	---	---	3	3	3	3	3	---	3	---	---	---	---	---	---	34	
36	914,4	---	---	3	3	3	3	3	---	3	---	---	---	---	---	---	36	
42	1067,0	Wallthickness 8,74 up to including 25,4 mm					3				3							42
48	1219,0	Wallthickness 8,74 up to including 25,4 mm					3				3							48

Code 2/3 means: 2 exposures, the elliptical technique "F" at 90° to each other or
3 exposures, superimposed technique "G" at 60° or 120° to each other.

Attachment C Weld reinforcement and Weld categories

The thickness of the weld reinforcement on each face shall not exceed the following:

Nominal material thickness [mm]	Maximum reinforcement	
	Category B & C butt welds [mm]	Other welds [mm]
< 2.4	2.5	0.8
≥ 2.4 ≤ 4.8	3.0	1.5
> 4.8 ≤ 13.0	4.0	2.5
> 13.0 ≤ 25.0	5.0	2.5
> 25.0 ≤ 51.0	6.0	3.0

Figure UW-3
Illustration of Welded Joint Locations Typical of Categories A, B, C, and D

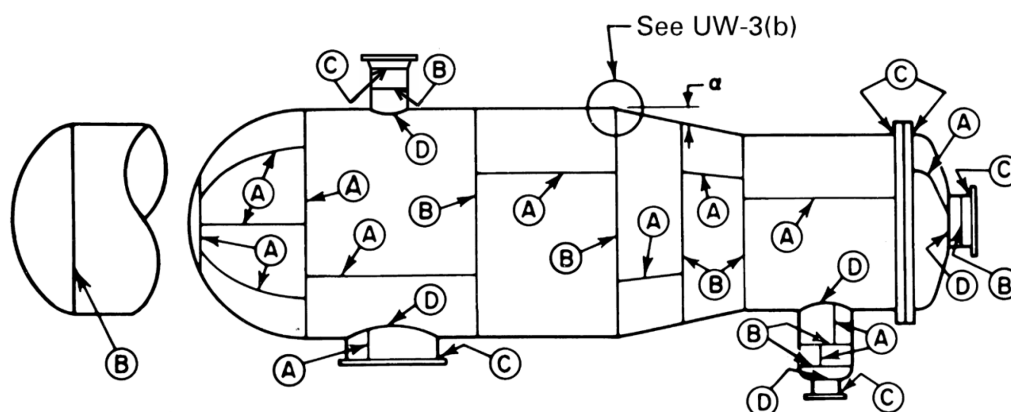

Category A. Longitudinal and spiral welded joints within the main shell, communicating chambers, transitions in diameter, or nozzles; any welded joint within a sphere, within a formed or flat head, or within the side plates of a flat-sided vessel; circumferential welded joints connecting hemispherical heads to main shells, to transitions in diameters, to nozzles, or to communicating chambers.

Category B. Circumferential welded joints within the main shell, communicating chambers, nozzles, or transitions in diameter including joints between the transition and a cylinder at either the large or small end; circumferential welded joints connecting formed heads other than hemispherical to main shells, to transitions in diameter, to nozzles, or to communicating chambers. Circumferential welded joints are butt joints if the half apex angle, α , is equal to or less than 30° and angle joints when α is greater than 30° (See Figure UW-3.)

Category C. Welded joints connecting flanges, tube sheets, or flat heads to main shell, to formed heads, to transitions in diameter, to nozzles, or to communicating chambers any welded joint connecting one side plate to another side plate of a flat-sided vessel.

Category D. Welded joints connecting communicating chambers or nozzles to main shells, to spheres, to transitions in diameter, to heads, or to flat-sided vessels, and those joints connecting nozzles to communicating chambers (for nozzles at the small end of a transition in diameter, see Category B).

Attachment D Location markers

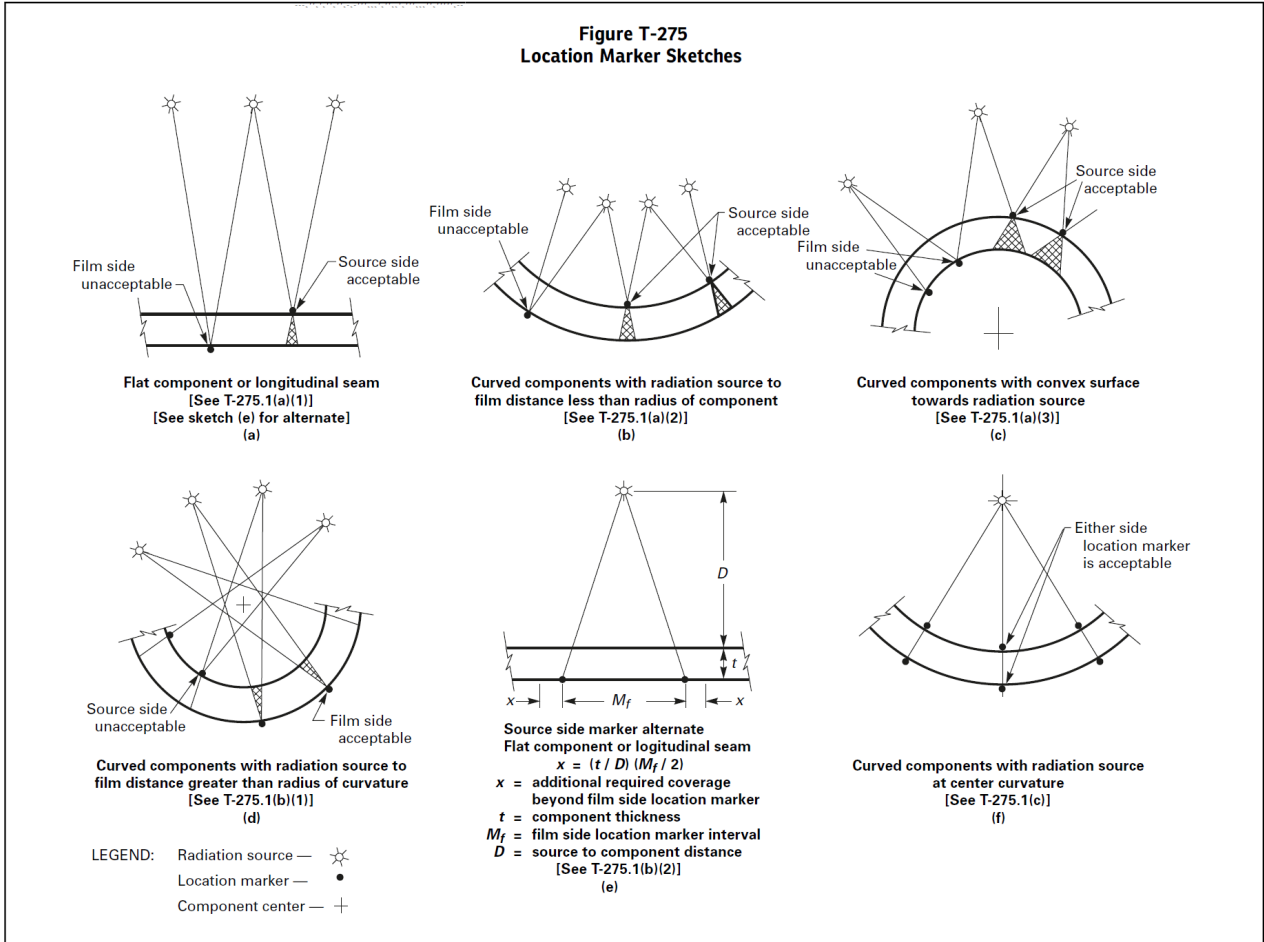

Location marker(s) on a small bore pipe

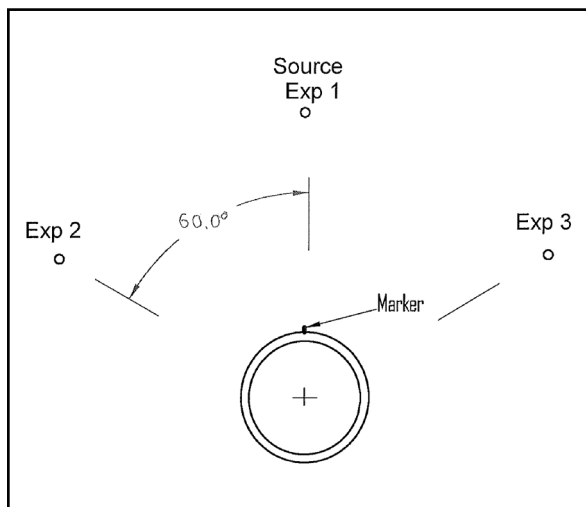

Attachment E IQI wire / hole number, thickness and type

IQI wire / hole number, thickness and type according ASME BPVC V, article 2 as shown below.

Set A		Set B	
Wire Diameter, in. (mm)	Wire Identity	Wire Diameter, in. (mm)	Wire Identity
0.0032 (0.08)	1	0.010 (0.25)	6
0.004 (0.10)	2	0.013 (0.33)	7
0.005 (0.13)	3	0.016 (0.41)	8
0.0063 (0.16)	4	0.020 (0.51)	9
0.008 (0.20)	5	0.025 (0.64)	10
0.010 (0.25)	6	0.032 (0.81)	11
Set C		Set D	
Wire Diameter, in. (mm)	Wire Identity	Wire Diameter, in. (mm)	Wire Identity
0.032 (0.81)	11	0.100 (2.54)	16
0.040 (1.02)	12	0.126 (3.20)	17
0.050 (1.27)	13	0.160 (4.06)	18
0.063 (1.60)	14	0.200 (5.08)	19
0.080 (2.03)	15	0.250 (6.35)	20
0.100 (2.54)	16	0.320 (8.13)	21

IQI Designation	IQI Thickness, in. (mm)	1T Hole Diameter, in. (mm)	2T Hole Diameter, in. (mm)	4T Hole Diameter, in. (mm)
5	0.005 (0.13)	0.010 (0.25)	0.020 (0.51)	0.040 (1.02)
7	0.0075 (0.19)	0.010 (0.25)	0.020 (0.51)	0.040 (1.02)
10	0.010 (0.25)	0.010 (0.25)	0.020 (0.51)	0.040 (1.02)
12	0.0125 (0.32)	0.0125 (0.32)	0.025 (0.64)	0.050 (1.27)
15	0.015 (0.38)	0.015 (0.38)	0.030 (0.76)	0.060 (1.52)
17	0.0175 (0.44)	0.0175 (0.44)	0.035 (0.89)	0.070 (1.78)
20	0.020 (0.51)	0.020 (0.51)	0.040 (1.02)	0.080 (2.03)
25	0.025 (0.64)	0.025 (0.64)	0.050 (1.27)	0.100 (2.54)
30	0.030 (0.76)	0.030 (0.76)	0.060 (1.52)	0.120 (3.05)
35	0.035 (0.89)	0.035 (0.89)	0.070 (1.78)	0.140 (3.56)
40	0.040 (1.02)	0.040 (1.02)	0.080 (2.03)	0.160 (4.06)
45	0.045 (1.14)	0.045 (1.14)	0.090 (2.29)	0.180 (4.57)
50	0.050 (1.27)	0.050 (1.27)	0.100 (2.54)	0.200 (5.08)
60	0.060 (1.52)	0.060 (1.52)	0.120 (3.05)	0.240 (6.10)
70	0.070 (1.78)	0.070 (1.78)	0.140 (3.56)	0.280 (7.11)
80	0.080 (2.03)	0.080 (2.03)	0.160 (4.06)	0.320 (8.13)
100	0.100 (2.54)	0.100 (2.54)	0.200 (5.08)	0.400 (10.16)
120	0.120 (3.05)	0.120 (3.05)	0.240 (6.10)	0.480 (12.19)
140	0.140 (3.56)	0.140 (3.56)	0.280 (7.11)	0.560 (14.22)
160	0.160 (4.06)	0.160 (4.06)	0.320 (8.13)	0.640 (16.26)
200	0.200 (5.08)	0.200 (5.08)	0.400 (10.16)	...
240	0.240 (6.10)	0.240 (6.10)	0.480 (12.19)	...
280	0.280 (7.11)	0.280 (7.11)	0.560 (14.22)	...

Doc Ref : RT 21002
Revision : 28
Date : 17-12-2019
Title : Radiographic examination
Type : Standard procedure



ASME BPVC V IQI set versus ISO 19232-1 IQI set.

IQI according ASME BPVC V SE-747					IQI according EN-ISO 19232-1				
Ø wire		IQI set			Ø wire	IQI set			
[In.]	[mm]	A	B	C	[mm]	13-19	10-16	6-12	1-6
					0.050	19			
					0.063	18			
0.0032	0.08	1			0.080	17			
0.004	0.1	2			0.100	16	16		
0.005	0.13	3			0.125	15	15		
0.0063	0.16	4			0.16	14	14		
0.008	0.2	5			0.20	13	13		
0.010	0.25	6	6		0.25		12	12	
0.013	0.33		7		0.32		11	11	
0.016	0.4		8		0.40		10	10	
0.020	0.51		9		0.50			9	
0.025	0.64		10		0.63			8	
0.032	0.81		11	11	0.80			7	7
0.040	1.02			12	1.00			6	6
0.050	1.27			13	1.25				5
0.063	1.6			14	1.60				4
0.080	2.03			15	2.00				3
0.100	2.5			16	2.50				2
					3.20				1

RADIOGRAPHIC ASSESSMENT PROCEDURE

Assessment of radiographic examination of welded joints in accordance with the requirements of one of the following standards:

- ASME BPVC Section I, edition 2021, paragraph PW 51**
- ASME BPVC Section VIII Division 1, edition 2021, paragraph UW 51**
- ASME BPVC Section VIII Division 1, edition 2021, paragraph UW 52**
- ASME BPVC Section VIII Division 2, edition 2021, paragraph 7.5.3.2**
- ASME BPVC Section IX, edition 2021, paragraph QW 191.1.2**
- ASME code for Power Piping, B31.1: 2020, table 136.4.5**
- ASME code for Process Piping, B31.3: 2020, table 341.3.2**

Development – Revisions					
Revision No.	Prepared By	Date	Approved By	Date	Amendment Details
28	T. Cornelissen	16-12-2021	T. Speelmeijer	16-12-2021	
27		02-04-2021			
0		01-08-1991			
		Digitally signed by Theo Cornelissen Date: 2021.12.17 08:56:43 +01'00'		Theo Speelmeijer MT3 PT3 RT3 UT3 	
Date:	16-12-2021	Date:	16-12-2021	Date:	

Address
 Delftweg 144, 3046 NC Rotterdam
 P.O. Box 10065, 3004 AB Rotterdam
 The Netherlands
www.ApplusRTD.com

This publication is the intellectual property of Applus+ and may not be used in whole or in part for any purpose other than the business of Applus+ and may not be used for the business of the recipient and may not be passed to any other person without the permission of Applus+.

Revision History

Revision Number	Date	Section	Brief Description of change	Author of Change
0	01-08-1991		Issued as new document	
18	14-12-2010	1, 2.1	updated to the ASME BPVC VIII 2010	R. Coenen
19	14-12-2011	1, 2.1	updated to the ASME BPVC VIII 2010 addenda 2011	R. Coenen
20	01-06-2012	2.1		R. Coenen
21	10-01-2014	2.1, 2.2, 2.3		R. Coenen
22	21-10-2015		updated to the ASME BPVC VIII 2015 edition	P. Briggeman
23	13-12-2017		updated to the ASME BPVC VIII 2017 edition	P. Briggeman
24	07-01-2020		Complete revised and updated to the ASME BPVC VIII 2019 edition	T. Cornelissen
25	01-12-2020		Amended several ASME acceptance standards	T. Cornelissen
26	05-03-2021	10 update ASME B31.1 Table removed from 5.1.2, 6.1.1, 8.3	Updated ASME B31.1 to 2020 version and typo's corrected, indicated in margins	T. Cornelissen
27	02-04-2021	5.1.1, 6.1.6, 10.2	References corrected	T. Cornelissen
28	16-12-2021	1, 10.2	Updated to the latest ASME editions	T. Cornelissen

Contents

1	Scope	4
2	References and abbreviations	4
2.1	<i>Applus+ documents</i>	4
2.2	<i>Codes and standards</i>	4
2.3	<i>Abbreviations</i>	4
2.4	<i>Definitions</i>	5
3	Personnel qualifications	5
4	General requirements	5
4.1	<i>Facilities for viewing of radiographs</i>	5
4.2	<i>Radiographic quality</i>	5
4.3	<i>Report</i>	6
5	ASME BPVC Section I, paragraph PW 51	7
5.1	<i>Evaluation</i>	7
5.2	<i>Rounded indication charts</i>	8
5.3	<i>Acceptance criteria</i>	10
6	ASME BPVC Section VIII Division 1, paragraph UW 51	11
6.1	<i>Evaluation</i>	11
6.2	<i>Acceptance criteria</i>	14
7	ASME BPVC Section VIII Division 1, paragraph UW 52	15
7.1	<i>Acceptance criteria</i>	15
8	ASME BPVC Section VIII Division 2, paragraph 7.5.3.2	16
8.1	<i>Evaluation</i>	16
8.2	<i>Acceptance criteria</i>	16
8.3	<i>Rounded indication charts</i>	16
9	ASME BPVC Section IX, paragraph QW 191.1.2	20
9.1	<i>Acceptance Criteria</i>	20
9.2	<i>Rounded indication chart</i>	20
10	ASME B31.1, paragraph 136.4.5	21
10.1	<i>Acceptance criteria linear indications</i>	21
10.2	<i>Acceptance criteria for rounded indications</i>	21
11	ASME B31.3, table 341.3.2	22
11.1	<i>Acceptance criteria for rounded indications</i>	22
11.2	<i>Table 341.3.2 Acceptance criteria for welds</i>	23

1 Scope

This procedure defines the radiographic assessment of radiographs which has been performed in accordance with the requirements of the ASME BPVC Section V, article 2.

Assessment of radiographic examination of welded joints will be in accordance with the requirements of one of the following standards and shall be specified by the client:

- ASME BPVC Section I, edition 2021, paragraph PW 51.
- ASME BPVC Section VIII Division 1, edition 2021, paragraph UW 51.
- ASME BPVC Section VIII Division 1, edition 2021, paragraph UW 52 (spot examination).
- ASME BPVC Section VIII Division 2, edition 2021, paragraph 7.5.3.2.
- ASME BPVC Section IX, edition 2021, paragraph QW 191.1.2.
- ASME code for Power Piping, B31.1: 2020, table 136.4.5.
- ASME code for Process Piping, B31.3: 2020, table 341.3.2.

2 References and abbreviations

For dated references, only the edition cited applies. For undated references, the latest edition of the referenced document (including any amendments) applies.

2.1 *Applus+ documents*

- NL-10 Written practice for the Training, Qualification, Certification and Authorization of NDT Personnel.
- CP 31003 Procedure for calibration of film densitometers.
- CP 31014 Verification procedure for illuminators used for industrial radiographs.

2.2 *Codes and standards*

- ASME BPVC I ASME Boiler and Pressure Vessel Code, an International Code, Rules for construction of power boilers.
- ASME BPVC V ASME Boiler and Pressure Vessel Code, an International Code, Non-destructive Examination.
- ASME BPVC VIII.1 ASME Boiler and Pressure Vessel Code, Division 1.
- ASME BPVC VIII.2 ASME Boiler and Pressure Vessel Code, Division 2.
- ASME BPVC IX ASME Boiler and Pressure Vessel Code, an International Code, Qualification Standard for Welding, Brazing, and Fusing Procedures; Welders; Brazers; and Welding, Brazing, and Fusing Operators.
- ASME B31.1 Power piping, ASME code for pressure piping, B31.
- ASME B31.3 Process piping, ASME code for pressure piping, B31.
- ISO 9712: 2012 Qualification and certification of NDT personnel.
- SNT-TC-1A: 2016 Personnel qualification and certification in NDT.

2.3 *Abbreviations*

ASME BPVC	ASME Boiler Pressure Vessel code
IQI	Image Quality Indicator
NDT	Non Destructive Testing
RT	Radiographic Testing
<i>t</i>	Nominal thickness of the parent material only where manufacturing tolerances do not have to be taken into account.

2.4 Definitions

Rounded indications

Indications with a maximum length of three times the width or less on the radiograph are defined as rounded indications. These indications may be circular, elliptical, conical or irregular in shape and may have tails. When evaluating the size of an indication, the tail shall be included. The indication may be from any imperfection in the weld, such as porosity, slag or tungsten.

Aligned indications

A sequence of four or more rounded indications shall be considered to be aligned when they touch a line parallel to the length of the weld drawn through the centre of the two outer rounded indications.

Elongated indications

Indications, not being a crack, lack of fusion or incomplete penetration, with a length greater than 3 times the width on the radiograph are defined as elongated indications.

Thickness (t)

t is the thickness of the weld, excluding any allowable reinforcement. For a butt weld joining two members having different thicknesses at the weld, t is the thinner of these two thicknesses. If a full penetration weld includes a fillet weld, the thickness of the fillet weld throat shall be included in t .

3 Personnel qualifications

NDT-personnel shall be qualified and certified in accordance with the valid version of Applus+ Written Practice NL-10, which is in conformity with the SNT-TC-1A and ISO 9712.

The assessment of the radiographs shall be performed only by certified personnel RT level 2 including Film Interpretation level 2 as minimum.

Shall have passed an eyesight examination within the past 12 months, according the ISO 9712 section 7.4 or equivalent.

4 General requirements

4.1 Facilities for viewing of radiographs

The proper assessment of image quality and accurate reporting on the diagnostic information of the radiographs shall be achieved by:

- The densitometer shall be verified according Applus+ procedure CP 31003 and shall have a valid certificate.
- The maximum density of the film assessed shall never exceed the light intensity incident of the film viewer.
- The film viewer and lamps shall be verified according Applus+ procedure CP 31014 and shall have a valid certificate.
- No light sources with a strength > 50 lux shall be visible when assessing the radiograph, to avoid dazzling.
- Means for magnifying details in the displayed radiographic image should be available. The magnifying glass shall be max 7x.
- The ambient light intensity measured on the film viewer (with the film viewer off) shall be ≤ 20 lux.

4.2 Radiographic quality

If the minimum requirement as described in the ASME BPVC V art.2 summerized in section 4.2.1 and 4.2.2 of this procedure are not met, the radiograph shall be rejected due to quality issues. If agreed between contracted parties the radiograph can maybe accepted.

4.2.1 Radiographic density limitations

The transmitted film density through the radiographic image of the body of the appropriate IQI and the area of interest shall be 1.8 minimum for single film viewing for radiographs made with an X-ray source and 2.0 minimum for radiographs made with a gamma-ray source.

The maximum density shall be 4.0 for either single or composite viewing, the maximum density of the film assessed shall never exceed the light intensity incident of the viewer.

A tolerance of ± 0.05 in density is allowed for variations between densitometer readings.

4.2.1 Weld reinforcement

If there is a question regarding the surface condition of the weld and the weld reinforcement when interpreting a radiographic film, the film shall be compared to the actual weld surface for determination of acceptability.

The values used for the estimated weld reinforcement thicknesses shall be representative of the weld conditions and shall not exceed the maximums permitted by the referencing Code Section. Physical measurement of the actual weld reinforcements is not required.

4.2.2 IQI sensitivity

The minimum sensitivity requirements of the radiographs shall be as mentioned in Table 1 below.

The thickness on which the IQI is based is the nominal single-wall material thickness plus the weld reinforcement thickness estimated to be present on both sides of the weld (I.D. and O.D.).

Backing rings or strips shall not be considered as part of the thickness in IQI selection.

Single Wall Material Thickness Range plus estimated weld reinforcement [mm]	Source Side			Film Side		
	Essential ISO wire	Essential ASTM wire	Plate No. 2T hole	Essential ISO wire	Essential ASTM wire	Plate No. 2T hole
Up to 6.4 incl.	13	5	12	14	4	10
Over 6.4 through 9.5	12	6	15	13	5	12
Over 9.5 through 12.7	11	7	17	12	6	15
Over 12.7 through 19.0	10	8	20	11	7	17
Over 19.0 through 25.4	9	9	25	10	8	20
Over 25.4 through 38.1	8	10	30	9	9	25
Over 38.1 through 50.8	7	11	35	8	10	30
Over 50.8 through 63.5	6	12	40	7	11	35
Over 63.5 through 101.6	5	13	50	6	12	40

Table 1: IQI sensitivity requirements

4.3 Report

The report shall be finalized with the results of the assessment, the following information shall be add to the report made for the examination as minimum by the radiograph interpreter:

- Procedure and revision number used.
- Relevant indications.
- Results of the assessment.
- Date of interpretation.
- Name and level personnel

5 ASME BPVC Section I, paragraph PW 51

5.1 Evaluation

5.1.1 Relevant indications

Only those rounded indications which exceed the following dimensions shall be considered relevant.

1/10t	for $t < 3.0$ mm.
0.4 mm	for $3 \text{ mm} \leq t \leq 6$ mm.
0.8 mm	for $6 \text{ mm} < t \leq 50$ mm.
1.6 mm	for $t > 50$ mm.

5.1.2 Maximum size of rounded indications

The maximum permissible size of any indication shall be $1/4t$, or 4 mm, whichever is smaller; except that an isolated indication separated from an adjacent indication by 25 mm or more may be $1/3t$, or 6 mm, whichever is less. For t greater than 50 mm, the maximum permissible size of an isolated indication shall be increased to 10 mm.

5.1.3 Aligned rounded indications

Aligned rounded indications are acceptable when the summation of the diameters of the indications is less than t in a length of $12t$, refer to: rounded indication charts A-250-3.4-1.

The length of groups of aligned rounded indications and the spacing between the groups shall meet the requirements of: rounded indication charts A-250-3.4-2.

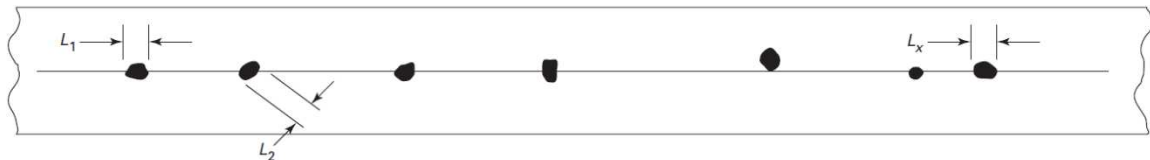

General note: Sum of L_2 to L_x shall be less than t in a length of $12t$.

Figure A-250 3.4-1. Aligned rounded indications

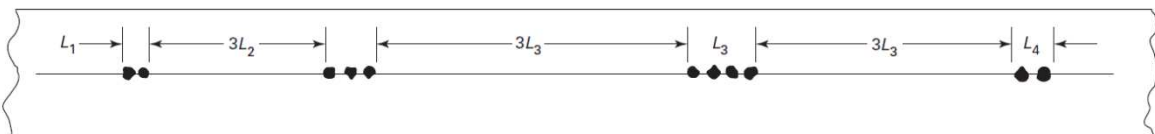

Maximum Group Length

L	=	6 mm for t less than 19 mm
L	=	$1/3t$ for t 19 mm to 57 mm
L	=	19 mm for t greater than 57 mm

Minimum Group Spacing

$3L$ where L is the length of the longest adjacent group being evaluated

GENERAL NOTE: Sum of the group lengths shall be less than t in a length of $12t$

Figure A-250 3.4-2. Groups of aligned rounded indications

5.1.4 Spacing

The distance between adjacent rounded indications is not a factor in determining acceptance or rejection, except as required for isolated indications or groups of aligned indications.

5.1.5 Weld thickness t less than 3.0 mm

For t less than 3.0 mm the maximum number of rounded indications shall not exceed 12 in any 150 mm weld length. A proportionally fewer number of indications shall be permitted in welds less than 150 mm in length.

5.1.6 Clustered indications

The illustrations for clustered indications show up to four times as many indications in a local area, as that shown in the illustrations for random indications. The length of an acceptable cluster shall not exceed the lesser of 25 mm or $2t$. Where more than one cluster present, the sum of the lengths of the clusters shall not exceed 25 mm in any 150 mm weld length.

5.2 Rounded indication charts

The rounded indications are characterized as imperfections shall not exceed that shown in the charts A-250.3.6-1 through A-250.3.6-5. These charts represent the maximum acceptable concentration limits for rounded indications in any 150 mm weld length.

Maximum size of individual rounded indications in the Figures A-250.3.6-1 up to A-250.3.6-5 shall be as per section 5.1.2.

The distributions shown are not necessarily the patterns that may appear on the radiograph, but are typical of the concentration and size of indications permitted.

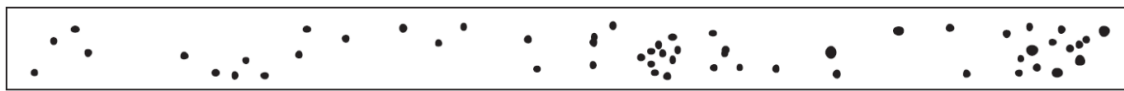

(a) Random Rounded Indications
 Typical concentration and size permitted in any 150 mm length of weld.

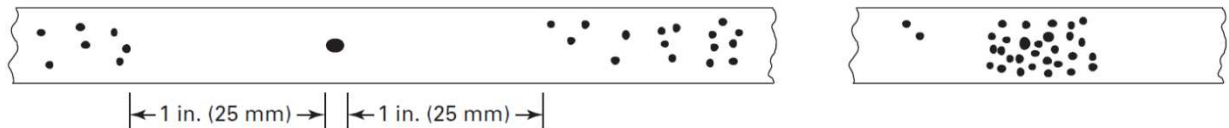

(b) Isolated Indication

(c) Cluster

Figure A-250 3.6-1. Charts for t 3 mm to 6 mm, inclusive



(a) Random Rounded Indications
 Typical concentration and size permitted in any 150 mm length of weld.

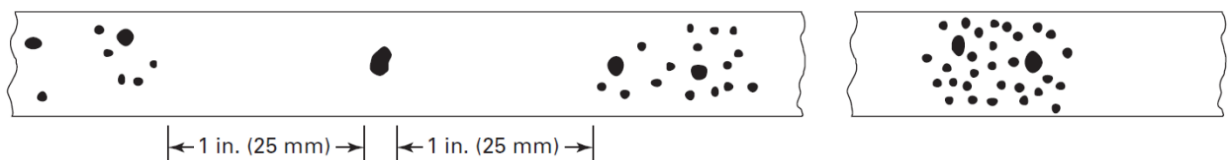

(b) Isolated Indication

(c) Cluster

Figure A-250 3.6-2. Charts for t 6 mm to 10 mm, inclusive

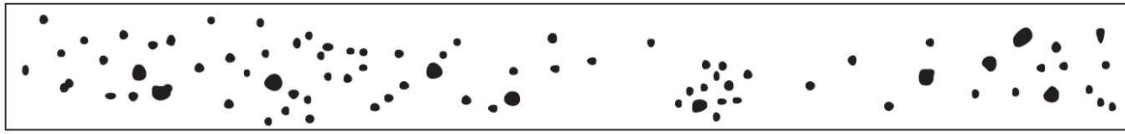

(a) Random Rounded Indications
 Typical concentration and size permitted in any 150 mm length of weld.

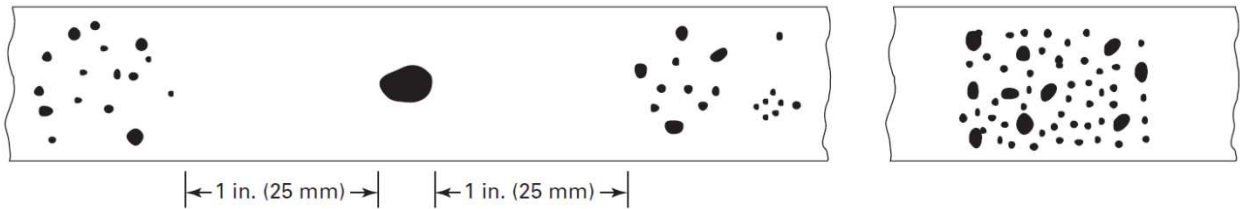

(b) Isolated Indication

(c) Cluster

Figure A-250.3.6-3. Charts for t over 10 mm to 19 mm, inclusive

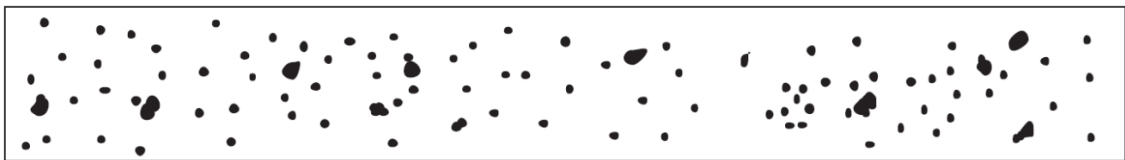

(a) Random Rounded Indications
 Typical concentration and size permitted in any 150 mm length of weld.

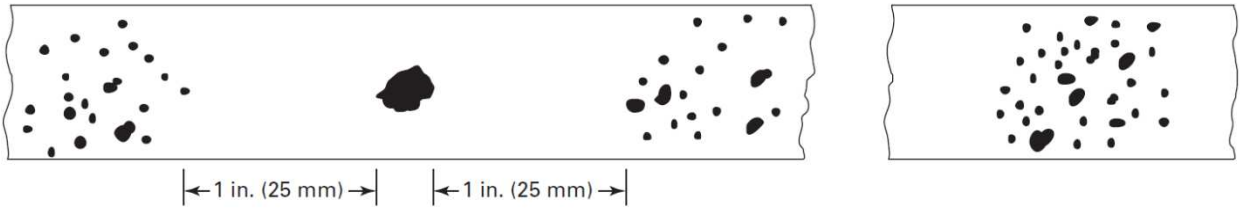

(b) Isolated Indication

(c) Cluster

Figure 250.3.6-4. Charts for t over 19 mm to 50 mm, inclusive

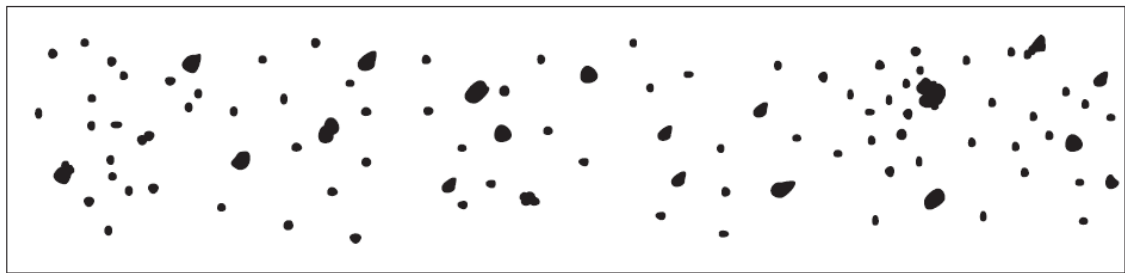

(a) Random Rounded Indications
 Typical concentration and size permitted in any 150 mm length of weld.

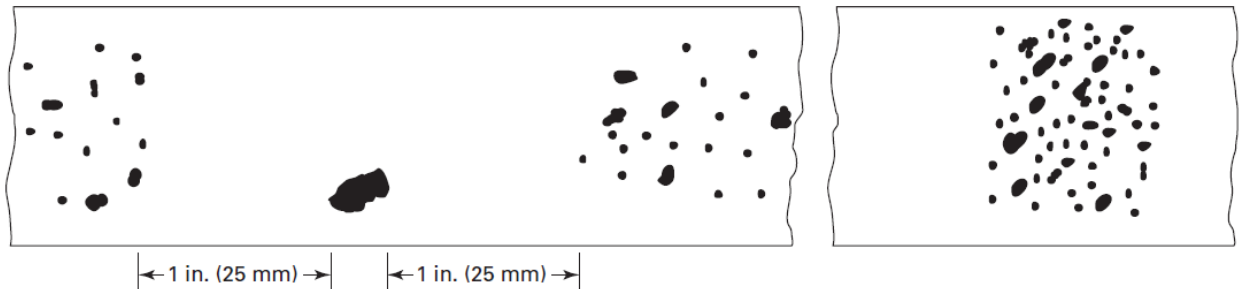

(b) Isolated Indication

(c) Cluster

Figure A-250.3.6-5. Charts for t over 50 mm to 100 mm, inclusive

5.3 Acceptance criteria

Density within the image of the indication may vary and is not a criterion for acceptance or rejection.

Indications shown on radiographs of welds and characterized as imperfections are unacceptable under the following conditions.

- Any indication characterized as a crack or zone of incomplete fusion or penetration.
- Any other elongated indication on the radiograph which has length greater than:
 - 6 mm for $t \leq 19$ mm.
 - $1/3t$ for $19 \text{ mm} < t \leq 57$ mm.
 - 19 mm for $t > 57$ mm.
- Any group of aligned indications that have an aggregate length greater than t in a length of $12t$ except when the distance between the successive imperfections exceeds $6L$ where L is the length of the longest imperfection in the group.
- Rounded indications in excess of that specified by the acceptance standards given in paragraph 5.1.2 up to 5.2.

6 ASME BPVC Section VIII Division 1, paragraph UW 51

6.1 Evaluation

6.1.1 Maximum size of rounded relevant indications

Only those rounded indications which exceed the following dimensions shall be considered relevant:

1/10 t	for $t < 3.0$ mm.
0.4 mm	for $3 \text{ mm} \leq t \leq 6$ mm.
0.8 mm	for $6 \text{ mm} < t \leq 50$ mm.
1.6 mm	for $t > 50$ mm.

The maximum permissible size of any indication shall be $1/4t$, or 4 mm, whichever is smaller; except that an isolated indication separated from an adjacent indication by 25 mm or more may be $1/3t$, or 6 mm, whichever is less. For t greater than 50 mm, the maximum permissible size of an isolated indication shall be increased to 10 mm.

6.1.2 Aligned rounded indications

Aligned rounded indications are acceptable when the summation of the diameters of the indications is less than t in any length of $12t$; refer to section 6.1.6 Rounded indication charts.

The length of groups of aligned rounded indications and the spacing between the groups shall meet the requirements of section 6.1.6.

6.1.3 Spacing

The distance between adjacent rounded indications is not a factor in determining acceptance or rejection, except as required for isolated indications or groups of aligned indications.

6.1.4 Weld thickness t less than 3.0 mm

For t less than 3.0 mm the maximum number of rounded indications shall not exceed 12 in any 150 mm weld length. A proportionally fewer number of indications shall be permitted in welds less than 150 mm in length.

6.1.5 Clustered indications

The illustrations for clustered indications show up to four times as many indications in a local area, as that shown in the illustrations for random indications. The length of an acceptable cluster shall not exceed the lesser of 25 mm or $2t$. Where more than one cluster is present, the sum of the lengths of the clusters shall not exceed 25 mm in any 150 mm weld length.

6.1.6 Rounded indication charts

The rounded indications characterized as imperfections shall not exceed that shown in the charts. The Figures 4-1 through 4-7 illustrate various types of assorted, randomly dispersed and clustered rounded indications for different weld thicknesses greater than 3.0 mm.

These charts represent the maximum acceptable concentration limits for rounded indications. The charts for each thickness range represent full-scale 150 mm radiographs.

Maximum size of individual rounded indications in the Figures 4-1 up to 4-7 shall be as per section 6.1.1.

The distributions shown are not necessarily the patterns that may appear on the radiograph, but are typical of the concentration and size of indications permitted.

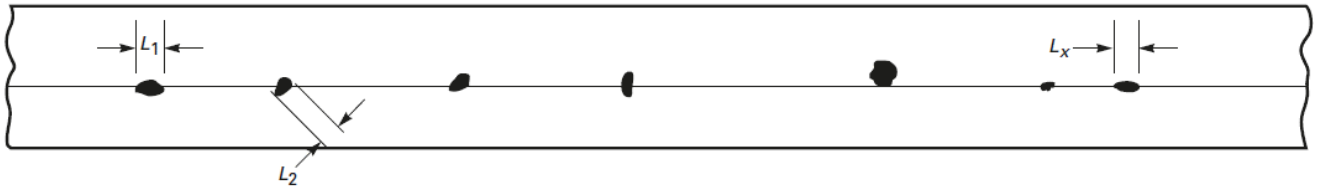

General note: Sum of L_1 to L_x shall be less than t in a length of $12t$.

Figure 4-1. Aligned rounded indications

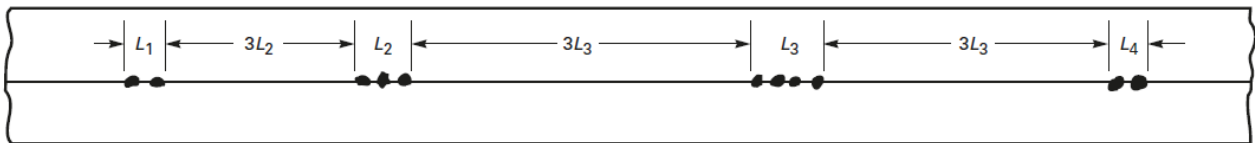

Maximum Group Length

- L = 6 mm for t less than 19 mm.
- L = $1/3t$ for t 19 mm to 57 mm.
- L = 19 mm for t greater than 57 mm.

Minimum Group Spacing

$3L$ where L is the length of the longest adjacent group being evaluated.

General note: Sum of the group lengths shall be less than t in a length of $12t$.

Figure 4-2. Groups of aligned rounded indications

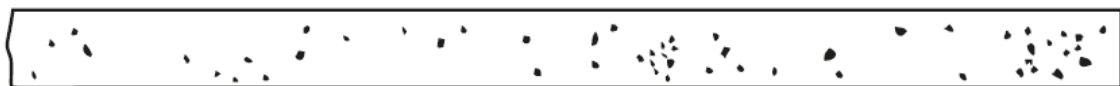

(a) Random rounded indications

Typical concentration and size permitted in any 150 mm length of weld.



(b) Isolated indications

Figure 4-3. Charts for t equal to 3 mm to 6 mm, inclusive

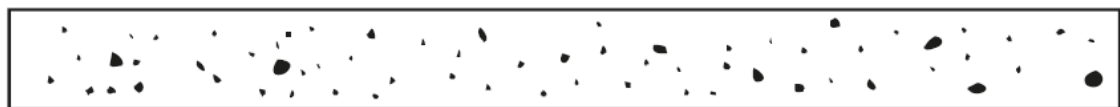

(a) Random Rounded Indications

Typical concentration and size permitted in any 150 mm length of weld.

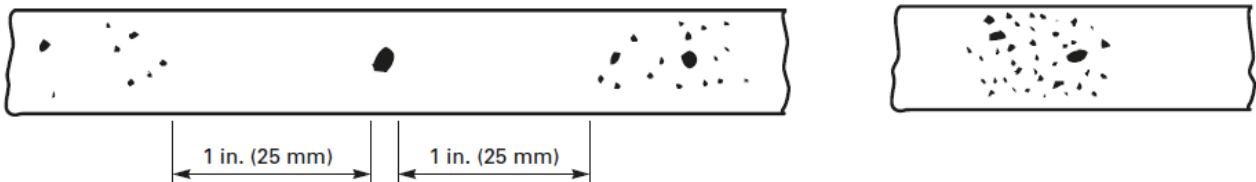

(b) Isolated Indication

(c) Cluster

Figure 4-4. Charts for t over 6 mm to 10 mm, inclusive

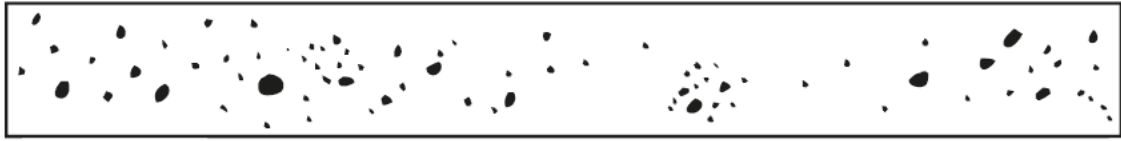

(a) Random Rounded Indications
 Typical concentration and size permitted in any 150 mm length of weld.

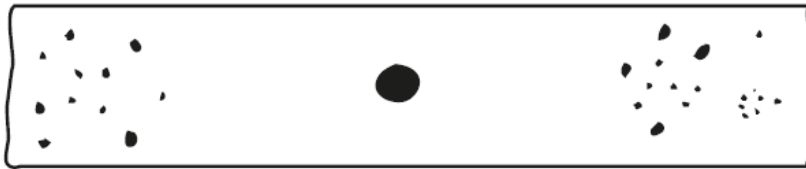

1 in. (25 mm) 1 in. (25 mm)

(b) Isolated Indication

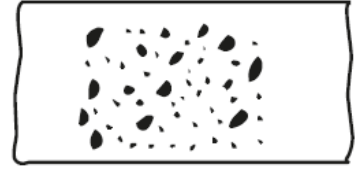

(c) Cluster

Figure 4-5. Charts for t over 10 mm to 19 mm, inclusive

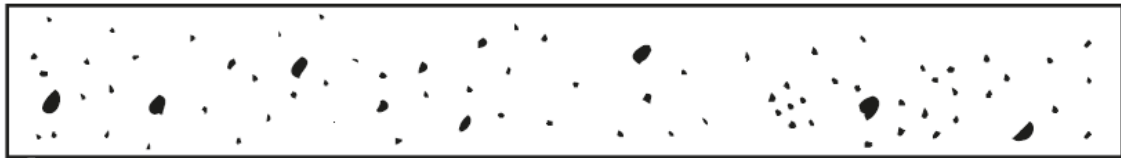

(a) Random Rounded Indications
 Typical concentration and size permitted in any 150 mm length of weld.

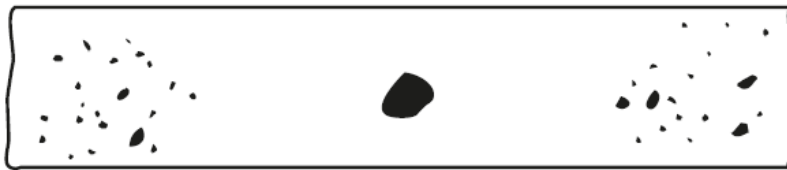

1 in. (25 mm) 1 in. (25 mm)

(b) Isolated Indication



(c) Cluster

Figure 4-6. Charts for t over 19 mm to 50 mm, inclusive

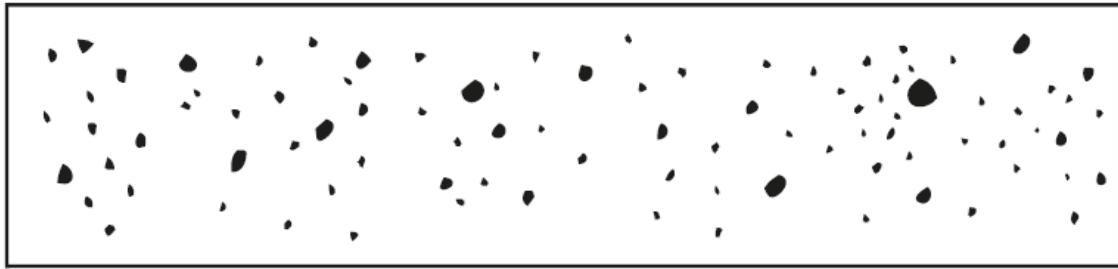

(a) Random Rounded Indications

Typical concentration and size permitted in any 150 mm length of weld.

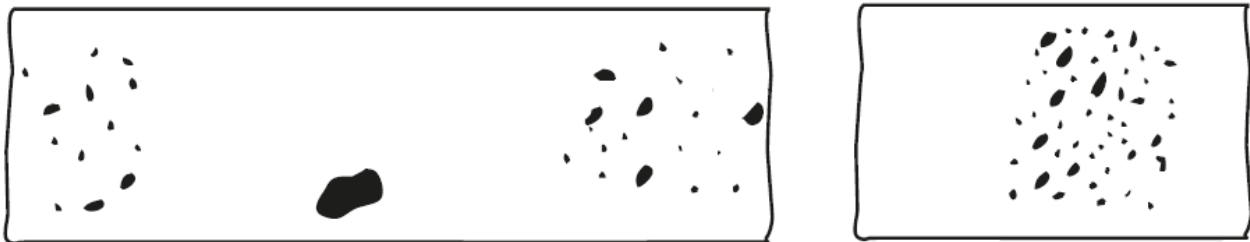

(b) Isolated Indication

(c) Cluster

Figure 4-7. Charts for t over 50 mm to 100 mm, inclusive

6.2 Acceptance criteria

Indications shown on radiographs of welds and characterized as imperfections are unacceptable under the following conditions.

- Any indication characterized as a crack or zone of incomplete fusion or penetration.
- Any other elongated indication on the radiograph which has length greater than:
 - 6 mm for $t < 19$ mm.
 - $1/3t$ for $19 \text{ mm} \leq t \leq 57$ mm.
 - 19 mm for $t > 57$ mm.
- Any group of aligned indications that have an aggregate length greater than t in a length of $12t$ except when the distance between the successive imperfections exceeds $6L$ where L is the length of the longest imperfection in the group.
- Rounded indications in excess of that specified by the acceptance standards given in paragraph 6.1.

7 ASME BPVC Section VIII Division 1, paragraph UW 52

7.1 Acceptance criteria

The acceptability of welds examined by spot radiography shall be judged by the following standard.

- Welds in which indications characterised as cracks or zones of incomplete fusion or penetration shall be unacceptable.
- Welds having indications characterized as slag inclusions or cavities are unacceptable when the indication length exceeds $2/3t$. For all thicknesses, indications less than 6 mm are acceptable, and indications greater than 19 mm are unacceptable.
- Multiple aligned indications meeting these acceptance criteria are acceptable when the sum of their longest dimensions indications does not exceed t within a length of $6t$ (or proportionally for radiographs shorter than $6t$), and when the longest length L for each indication is separated by a distance not less than $3L$ from adjacent indications.
- Rounded indications are not a factor in the acceptability of welds not required to be fully radiographed.

8 ASME BPVC Section VIII Division 2, paragraph 7.5.3.2

8.1 Evaluation

8.1.1 Maximum size of rounded relevant indications

Only those rounded indications which exceed the following dimensions shall be considered relevant:

1/10 t	for $t < 3.0$ mm.
0.4 mm	for $3 \text{ mm} \leq t \leq 6$ mm.
0.8 mm	for $6 \text{ mm} < t \leq 50$ mm.
1.5 mm	for $t > 50$ mm.

8.2 Acceptance criteria

8.2.1 Aligned rounded indications

Aligned rounded indications are acceptable when the summation of the diameters of the indications is less than t in any length of $12t$.

8.2.2 Spacing

The distance between adjacent rounded indications is not a factor in determining acceptance or rejection, except as required for isolated indications or groups of aligned indications.

8.2.3 Weld thickness t less than 3.0 mm

For t less than 3.0 mm the maximum number of rounded indications shall not exceed 12 in every 150 mm weld length. A proportionally fewer number of indications shall be permitted in welds less than 150 mm in length.

8.2.4 Clustered indications

The illustrations for clustered indications show up to four times as many indications in a local area, as that shown in the illustrations for random indications. The length of an acceptable cluster shall not exceed the lesser of 25 mm or $2t$. Where more than one cluster is present, the sum of the lengths of the clusters shall not exceed 25 mm in any 150 mm weld length.

8.3 Rounded indication charts

The rounded indications characterized as imperfections shall not exceed that shown in the charts. The Figures 7-3 up to 7-9 illustrate various types of assorted, randomly dispersed and clustered rounded indications for different weld thicknesses greater than 3.0 mm.

These charts represent the maximum acceptable concentration limits for rounded indications. The charts for each thickness range represent full-scale 150 mm radiographs.

Maximum size of individual rounded indications in the Figures 7-3 up to 7-9 shall be as per section 8.1.1.

The distributions shown are not necessarily the patterns that may appear on the radiograph, but are typical of the concentration and size of indications permitted.

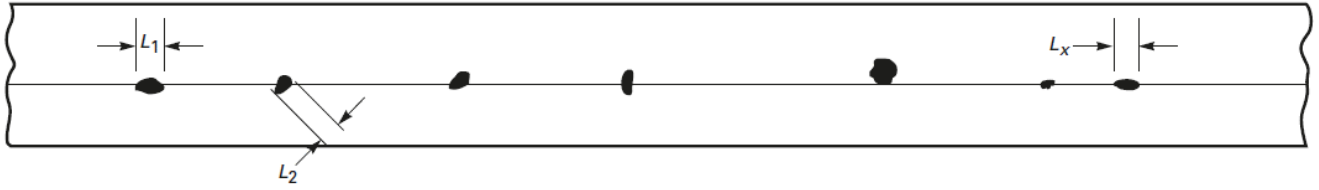

General note: Sum of L_1 to L_x shall be less than t in a length of $12t$.

Figure 7-3. Aligned rounded indications

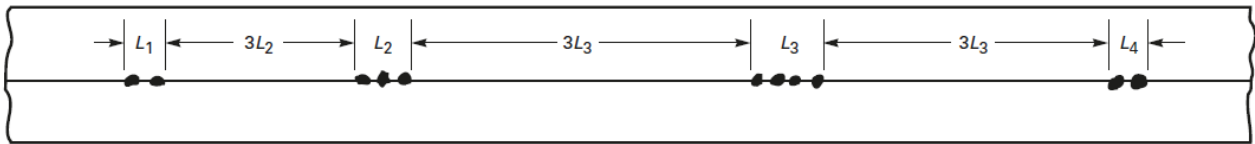

Maximum Group Length

- L = 6 mm for t less than 19 mm.
- L = $1/3t$ for t 19 mm to 57 mm.
- L = 19 mm for t greater than 57 mm.

Minimum Group Spacing

$3L$ where L is the length of the longest adjacent group being evaluated.

General note: Sum of the group lengths shall be less than t in a length of $12t$.

Figure 7-4. Groups of aligned rounded indications

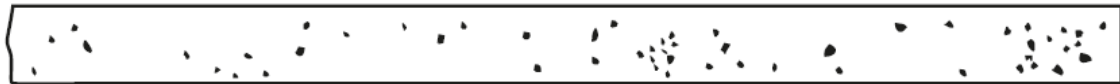

(c) Random rounded indications
 Typical concentration and size permitted in any 150 mm length of weld.

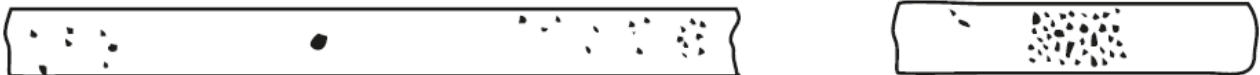

(d) Isolated indications

Figure 7-5. Charts for t equal to 3 mm to 6 mm, inclusive

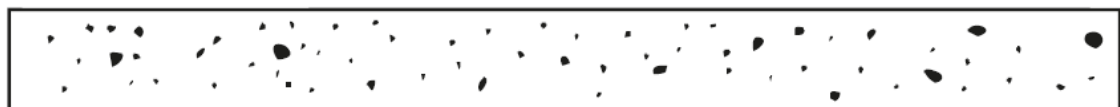

(a) Random Rounded Indications
 Typical concentration and size permitted in any 150 mm length of weld.



(b) Isolated Indication

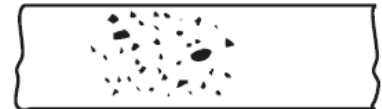

(c) Cluster



Figure 7-6. Charts for t over 6 mm to 10 mm, inclusive

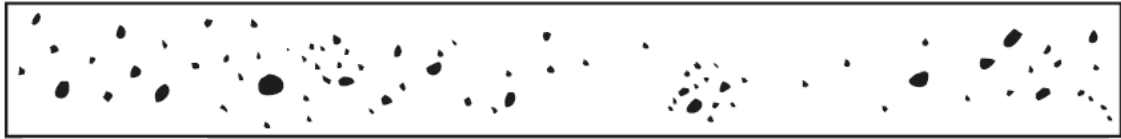

(a) Random Rounded Indications
 Typical concentration and size permitted in any 150 mm length of weld.

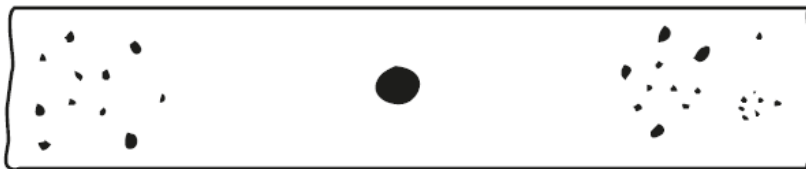

(b) Isolated Indication

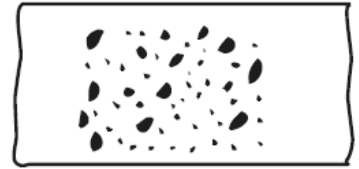

(c) Cluster

Figure 7-7. Charts for t over 10 mm to 19 mm, inclusive



(a) Random Rounded Indications
 Typical concentration and size permitted in any 150 mm length of weld.



(b) Isolated Indication



(c) Cluster

Figure 7-8. Charts for t over 19 mm to 50 mm, inclusive

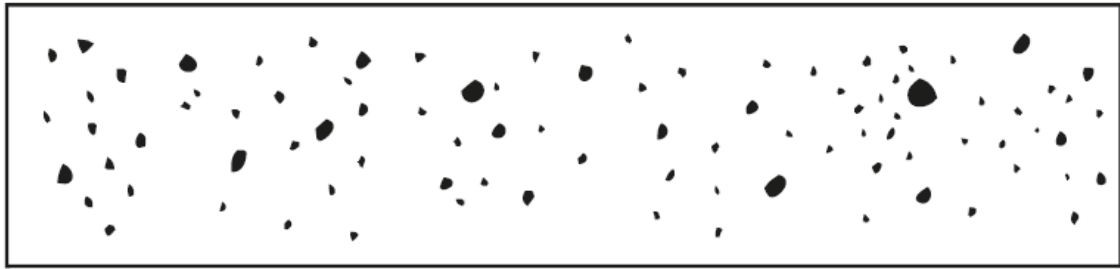

(a) Random Rounded Indications

Typical concentration and size permitted in any 150 mm length of weld.

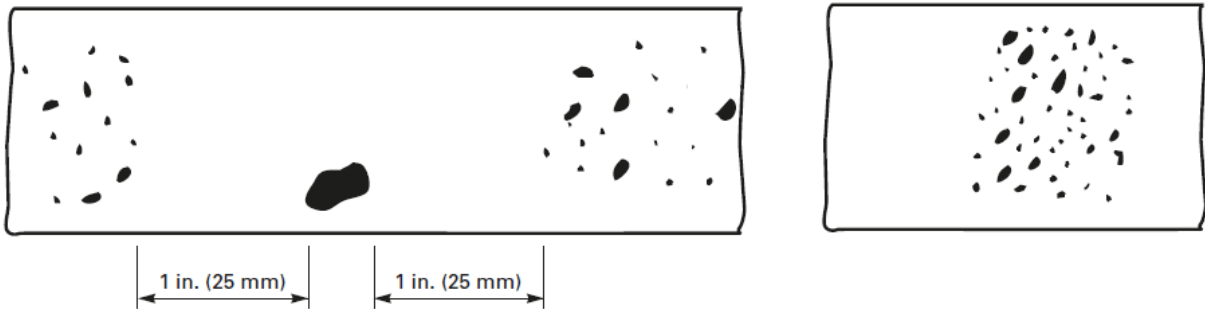

(b) Isolated Indication

(c) Cluster

Figure 7-9. Charts for t over 50 mm to 100 mm, inclusive

Indications shown on radiographs of welds and characterized as imperfections are unacceptable under the following conditions.

- Any indication characterized as a crack or zone of incomplete fusion or penetration.
- Any other elongated indication on the radiograph which has length greater than:
 - 6 mm for $t \leq 19$ mm.
 - $1/3t$ for $19 \text{ mm} \leq t \leq 57$ mm.
 - 19 mm for $t > 57$ mm.
- Any group of aligned indications that have an aggregate length greater than t in a length of $12t$ except when the distance between the successive imperfections exceeds $6L$ where L is the length of the longest imperfection in the group.
- Internal root conditions are acceptable when the density or image brightness change as indicated in the radiograph is not abrupt. Linear indication on the radiograph at either edge of such conditions shall be evaluated with bullet above.
- Rounded indications in excess of that specified by the acceptance standards given below.

The maximum permissible size of any indication shall be $1/4t$, or 4 mm, whichever is smaller; except that an isolated indication separated from an adjacent indication by 25 mm or more may be $1/3t$, or 6 mm, whichever is less. For t greater than 50 mm, the maximum permissible size of an isolated indication shall be increased to 10 mm.

9 ASME BPVC Section IX, paragraph QW 191.1.2

9.1 Acceptance Criteria

Welder and welding operator performance test by radiography of welds in test assemblies shall be judged unacceptable when the radiograph exhibits any imperfections in excess of the limits specified below.

9.1.1 Linear indications

- Any type of crack or zone of incomplete fusion or penetration.
- Any elongated slag inclusion which has a length greater than:
 - 3 mm for $t \leq 10$ mm.
 - $1/3t$ for $10 \text{ mm} < t \leq 57$ mm.
 - 19 mm for $t > 57$ mm.
- Any group or slag inclusion in line that have an aggregate length greater than t in a length of $12t$, except when the distance between the successive imperfections exceeds $6L$ where L is the length of the longest imperfection in the group.

9.1.2 Rounded indications

- The maximum permissible dimension for rounded indications shall be 20% of t or 3 mm, whichever is smaller.
- For welds in material less than 3 mm in thickness, the maximum number of acceptable rounded indications shall not exceed 12 in a 150 mm length of weld. A proportionally fewer number of rounded indications shall be permitted in welds less than 150 mm in length.
- For welds in material 3 mm or greater in thickness, the charts in section 9.2 represent the maximum acceptable type of rounded indications illustrated in typically clustered, assorted and randomly dispersed configurations. Rounded indications less than 0.8 mm in maximum diameter shall not be considered in the radiographic acceptance tests of welders and welding operators in these ranges of material thicknesses.

9.2 Rounded indication chart

These charts represent the maximum acceptable concentration limits for rounded indications. The charts for each thickness range represent full-scale 150 mm radiographs.

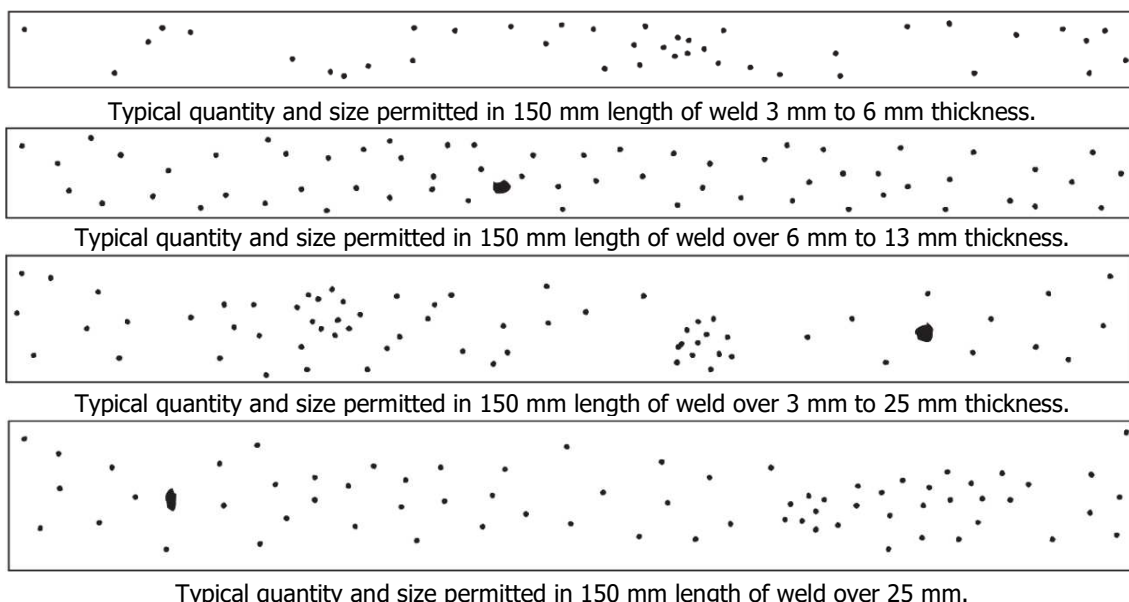

Figure QW-191.1.2.2(b)(4) Rounded indication charts

10 ASME B31.1, paragraph 136.4.5

10.1 Acceptance criteria linear indications

Indications shown on radiographs of welds and characterized as imperfections are unacceptable under the following conditions:

Any type of crack or zone of incomplete fusion or penetration.

Any other elongated indication that has a length greater than:

- 6.0 mm for $t \leq 19.0$ mm.
- $1/3t$ for $19.0 \text{ mm} < t \leq 57.0$ mm.
- 19.0 mm for $t > 57.0$ mm.

If a weld joins two members having different thickness at the weld, t is the thinner of these two thicknesses.

Any group of indications in line that have an aggregate length greater than t in a length of $12t$, except where the distance between the successive indications exceeds $6L$ where L is the longest indication in the group.

Root concavity when there is an abrupt change in density, as indicated on the radiograph.

10.2 Acceptance criteria for rounded indications

Porosity in excess of that shown as acceptable in non-mandatory appendix A, A-250 of ASME BPVC section I, refer to section 5.1.1 up to 5.3 of this procedure.

11 ASME B31.3, table 341.3.2

Indications shown on radiographs of welds and characterized as imperfections are unacceptable under the following conditions as stated into, table 341.3.2 (as shown in section 11.2) for the service conditions discussed.

If no service condition is given the "Severe Cyclic Condition" shall be used.

11.1 Acceptance criteria for rounded indications

The acceptance criteria for rounded indications shall be as per Table 341.3.2, symbol D and E,(refer to section 11.2) and to the ASME BPVC, section VIII, Division 1, Appendix 4 as described in section 6.1.1 through 6.2 of this procedure.

11.1.1 Image density

Density within the image of the indication may vary and is not a criterion for acceptance or rejection.

11.2 Table 341.3.2 Acceptance criteria for welds

Table 341.3.2 Acceptance Criteria for Welds — Visual and Radiographic Examination

Normal and Category M Fluid Service		Severe Cyclic Conditions				Category D Fluid Service				Examination Methods	
		Longitudinal Groove Weld [Note (3)]	Fillet Weld [Note (4)]	Girth, Miter Groove, and Branch Connection Welds [Note (2)]	Longitudinal Groove Weld [Note (3)]	Fillet Weld [Note (4)]	Girth and Miter Groove Welds	Longitudinal Groove Weld [Note (3)]	Fillet Weld [Note (4)]	Branch Connection Weld [Note (2)]	Visual
A	A	A	A	A	A	A	A	A	A	✓	✓
A	A	A	A	A	C	A	A	N/A	A	✓	✓
B	A	N/A	N/A	A	C	A	A	N/A	B	✓	✓
E	N/A	N/A	N/A	D	N/A	N/A	N/A	N/A	N/A	...	✓
G	N/A	N/A	N/A	F	N/A	N/A	N/A	N/A	N/A	...	✓
H	H	A	A	A	I	A	A	H	H	✓	✓
A	A	A	A	A	A	A	A	A	A	✓	...
N/A	N/A	N/A	J	J	N/A	N/A	N/A	N/A	N/A	✓	...
K	N/A	N/A	K	K	K	K	K	N/A	K	✓	✓
L	L	L	L	L	M	M	M	M	M	✓	...

GENERAL NOTES:

- (a) Weld imperfections are evaluated by one or more of the types of examination methods given, as specified in paras. 341.4.1, 341.4.2, 341.4.3, and M341.4, or by the engineering design.
 - (b) "N/A" indicates the Code does not establish acceptance criteria or does not require evaluation of this kind of imperfection for this type of weld.
 - (c) Check (✓) indicates examination method generally used for evaluating this kind of weld imperfection.
 - (d) Ellipsis (...) indicates examination method not generally used for evaluating this kind of weld imperfection.
- NOTES:**
- (1) Criteria given are for required examination. More-stringent criteria may be specified in the engineering design. See also paras. 341.5 and 341.5.3.
 - (2) Branch connection weld includes pressure containing welds in branches and fabricated laps.
 - (3) Longitudinal groove weld includes straight and spiral (helical) seam. Criteria are not intended to apply to welds made in accordance with a standard listed in Table A-1, Table A-1M, or Table 326.1. Alternative Leak Test requires examination of these welds; see para. 345.9.
 - (4) Fillet weld includes socket and seal welds, and attachment welds for slip-on flanges, branch reinforcement, and supports.
 - (5) These imperfections are evaluated only for welds ≤5 mm ($\frac{3}{16}$ in.) in nominal thickness.

Criterion Value Notes for Table 341.3.2

Symbol	Criterion	Measure	Acceptable Value Limits [Note (1)]
A	Extent of imperfection		Zero (no evident imperfection)
B	Cumulative length of incomplete penetration		≤38 mm (1.5 in.) in any 150 mm (6 in.) weld length or 25% of total weld length, whichever is less
C	Cumulative length of lack of fusion and incomplete penetration		≤38 mm (1.5 in.) in any 150 mm (6 in.) weld length or 25% of total weld length, whichever is less
D	Size and distribution of rounded indications		See ASME BPVC, Section VIII, Division 1, Appendix 4 [Note (2)]
E	Size and distribution of rounded indications		For $\bar{T}_w \leq 6$ mm ($\frac{1}{4}$ in.), limit is same as D [Note (2)] For $\bar{T}_w > 6$ mm ($\frac{1}{4}$ in.), limit is $1.5 \times D$ [Note (2)]
F	Linear indications		≤ $\bar{T}_w/3$
	Individual length		≤2.5 mm ($\frac{3}{32}$ in.) and ≤ $\bar{T}_w/3$
	Individual width		≤ \bar{T}_w in any 12 \bar{T}_w weld length [Note (2)]
G	Cumulative length		≤2 \bar{T}_w
	Linear indications		≤3 mm ($\frac{1}{8}$ in.) and ≤ $\bar{T}_w/2$
	Individual length		≤4 \bar{T}_w in any 150 mm (6 in.) weld length [Note (2)]
	Individual width		≤1 mm ($\frac{1}{32}$ in.) and ≤ $\bar{T}_w/4$
H	Cumulative length		≤38 mm (1.5 in.) in any 150 mm (6 in.) weld length or 25% of total weld length, whichever is less
	Depth of undercut		≤1.5 mm ($\frac{1}{16}$ in.) and ≤ $\bar{T}_w/4$ or 1 mm ($\frac{1}{32}$ in.)
I	Cumulative length of internal and external undercut		≤38 mm (1.5 in.) in any 150 mm (6 in.) weld length or 25% of total weld length, whichever is less
	Depth of undercut		≤38 mm (1.5 in.) in any 150 mm (6 in.) weld length or 25% of total weld length, whichever is less
J	Surface roughness		≤12.5 μm (500 μin.) R_a in accordance with ASME B46.1
K	Depth of surface concavity, root concavity, or burn-through		Total joint thickness, including weld reinforcement, ≥ \bar{T}_w [Notes (3) and (4)]
L	Height of reinforcement or internal protrusion [Note (5)] in any plane through the weld shall be within limits of the applicable height value in the tabulation at right, except as provided in Note (6). Weld metal shall merge smoothly into the component surfaces.	For \bar{T}_w , mm (in.)	Height, mm (in.)
		≤6 ($\frac{1}{4}$)	≤1.5 ($\frac{1}{16}$)
		>6 ($\frac{1}{4}$), ≤13 ($\frac{1}{2}$)	≤3 ($\frac{1}{8}$)
		>13 ($\frac{1}{2}$), ≤25 (1)	≤4 ($\frac{5}{32}$)
		>25 (1)	≤5 ($\frac{3}{16}$)
M	Height of reinforcement or internal protrusion [Note (5)] as described in L. Note (6) does not apply.		Limit is twice the value applicable for L above

NOTES:

(1) Where two limiting values are separated by "and," the lesser of the values determines acceptance. Where two sets of values are separated by "or," the larger value is acceptable. \bar{T}_w is the nominal wall thickness of the thinner of two components joined by a butt weld.

Criterion Value Notes for Table 341.3.2 (Cont'd)

NOTES: (Cont'd)

- (2) Porosity and inclusions such as slag or tungsten are defined as rounded indications where the maximum length is three times the width or less. These indications may be circular, elliptical, or irregular in shape; may have tails; and may vary in density. Indications where the length is greater than three times the width are defined as linear indications and may also be slag, porosity, or tungsten.
- (3) For circumferential groove welded joints in pipe, tube, and headers made entirely without the addition of filler metal, external concavity shall not exceed the lesser of 1 mm ($1/32$ in.) or 10% of the joint nominal thickness. The contour of the concavity shall blend smoothly with the base metal. The total joint thickness, including any reinforcement, shall not be less than the minimum wall thickness, t_m .
- (4) For radiography, acceptability may be determined by comparing the density of the image through the affected area to the density through the adjacent base metal (\bar{T}_w). If digital radiography is used, brightness comparison may be utilized. A density or brightness darker than the adjacent base metal is cause for rejection.
- (5) For groove welds, height is the lesser of the measurements made from the surfaces of the adjacent components; both reinforcement and internal protrusion are permitted in a weld. For fillet welds, height is measured from the theoretical throat, [Figure 328.5.2A](#); internal protrusion does not apply.
- (6) For welds in aluminum alloy only, internal protrusion shall not exceed the following values:
 - (a) 1.5 mm ($1/16$ in.) for thickness ≤ 2 mm ($5/64$ in.)
 - (b) 2.5 mm ($1/8$ in.) for thickness > 2 mm and ≤ 6 mm ($1/4$ in.)For external reinforcement and for greater thicknesses, see the tabulation for symbol L.