











OWNER:  شرکت سست و سویی گستره ایران (سهامی خاص)	BUSHEHR PETROCHEMICAL COMPANY MEG PLANT						EPC CONTRACTOR:  Chagalesh-Enerchimi-Steam Joint Venture BUPC-MEG PLANT PROJECT		
	UCP/LCP/JB GENERAL ARRANGEMENT DRAWING & TERMINAL DETAILS FOR EMERGENCY INSTRUMENT AIR COMPRESSOR INCL. BOM						 Netherlands		
MC :  شرکت سست و سویی گستره ایران (سهامی خاص)	Project	Area	Phase	Unit	Dis.	Doc.	Seq.	Contract No: 52-98/445	
Owner Document Number: 17811-07B	BU	20	VD	303	IN	DWG	0089	Rev.:	Page
								02	1 of 8

UCP/LCP/JB GENERAL ARRANGEMENT DRAWING & TERMINAL DETAILS FOR EMERGENCY INSTRUMENT AIR COMPRESSOR INCL. BOM

 شرکت سست و سویی گستره ایران (سهامی خاص)	 Chagalesh-Enerchimi-Steam Joint Venture BUPC-MEG PLANT PROJECT	BUSHEHR PETROCHEMICAL COMPANY MEG PLANT
Document Review		
Issue Purpose:	IFA	
Result Code: AP,AN,CM,RE,NC	CM	
Next Status : IFC,IFA,IFI,AFC,AB	IFA	
Responsible Department	MECHANICAL	
Commented Date	7/6/2022	
Approval or review hereunder shall not be construed to relieve Vendor / Subcontractor of his responsibilities and liability under the contract.		

02	16/06/2022	For approval	BK	RB	KP	
02	14/12/2021	For approval	HT	RB	KP	
01	19/10/2021	For approval	HT	RB	KP	
00	24/11/2020	For approval	HT	RB	KP	
Rev.	Date	Purpose of Issue	Prepared	Checked	Approved	AC Code
					Class: 1	Phase: P

OWNER:  شرکت مست و سوبی نوسا ایرانیا (سهامی خاص)	BUSHEHR PETROCHEMICAL COMPANY MEG PLANT						EPC CONTRACTOR  Chagalesh-Enerchimi-Steam Joint Venture BUPC-MEG PLANT PROJECT		
	UCP/LCP/JB GENERAL ARRANGEMENT DRAWING & TERMINAL DETAILS FOR EMERGENCY INSTRUMENT AIR COMPRESSOR INCL. BOM						 Netherlands		
MC :  شرکت مست و سوبی نوسا ایرانیا (سهامی خاص)	Project	Area	Phase	Unit	Dis.	Doc.	Seq.	Contract No: 52-98/445	
Owner Document Number: 17811-07B	BU	20	VD	303	IN	DWG	0089	Rev.:	Page
								02	2 of 8

TABULATION OF REVISED PAGES

Page	D00	D01	D02	D03	D04
1.	X	X	X	X	
2.	X	X	X	X	
3.	X	X	X	X	
4.	X	X	X	X	
5.	X	X	X	X	
6.	X	X	X	X	
7.	X	X	X	X	
8.	X	X	X	X	
9.	X				
10.	X				
11.	X				
12.	X				
13.	X				
14.					
15.					
16.					
17.					
18.					
19.					
20.					
21.					
22.					
23.					
24.					
25.					
26.					
27.					
28.					
29.					
30.					
31.					
32.					
33.					
34.					

Page	D00	D01	D02	D03	D04
35.					
36.					
37.					
38.					
39.					
40.					
41.					
42.					
43.					
44.					
45.					
46.					
47.					
48.					
49.					
50.					
51.					
52.					
53.					
54.					
55.					
56.					
57.					
58.					
59.					
60.					
61.					
62.					
63.					
64.					
65.					
66.					
67.					

Nr	Description	Tagnumber	Make	Qty
1.	Panel power on lamp (white)	2H19	Schneider	1
2.	Display	8A9	Siemens	1
3.	Hourmeter	16U12	Bauser	1
4.	Operational lamp (green)	16H4	Schneider	1
5.	Running lamp (green)	16H6	Schneider	1
6.	Common alarm lamp (amber)	16H8	Schneider	1
7.	Common trip lamp (red)	16H10	Schneider	1
8.	Start pushbutton (green)	10S4	Schneider	1
9.	Stop pushbutton (red)	10S6	Schneider	1
10.	Accept pushbutton (black)	10S10	Schneider	1
11.	Reset pushbutton (black)	10S12	Schneider	1
12.	Lamp test pushbutton (black)	10S8	Schneider	1
13.	ESD button	3S3	Schneider	1
14.	Maintenance switch	2S2, 2S4, 2S6	Schneider	3
15.	Panel fan + outlet filter	2M11	Rittal	1
16.	PLC power supply	5M2, 5M11	Siemens	2
17.	CPU	5M3, 5M12	Siemens	2
18.	Panel light	2H10	Rittal	1
19.	Ethernet switch	5M18	Siemens	1
20.	Profibus DP module	6M2, 6M3, 7M2, 7M3	Siemens	4
21.	CP 343-1 module	6M4, 7M4	Siemens	2
22.	32 Digital input module	6M7, 7M7	Siemens	2
23.	8 Analog input module	6M9, 6M10, 7M9, 7M10	Siemens	4
24.	32 Digital output module	6M11, 7M11	Siemens	2
25.	Interface relay	3K16/17, 17K16, 18K4/6/8/10/12, 19K4/6/10, 20K14, 32K4/6/8/10/12/14, 33K4, 34K4	Phoenix contact	21
26.	ESD relay	3ESDR2, 3ESDR8	Pilz	2
27.	Miniature circuit breaker 1P+N 110VAC / 230VAC	2F9, 2F11, 2F13, 2F15, 2F17	Schneider	5
28.	Thermostat	2TH11, 2TH13	Rittal	2
29.	Panel power supply	2V15, 2V17	Phoenix contact	2
30.	Miniature circuit breaker 1P	215.1, 2F17.1	Schneider	2
31.	Loop splitter	9U4/5/6/6.1/7/8/9/10/11/12/13	Pepperl+Fuchs	11
32.	Panel heater	2U13	Rittal	1
33.	Miniature circuit breaker 1P+N 24VDC	5F2, 5F11	Schneider	2
34.	Diode	9V4, 9V4.1, 16V4/6/8/10/12/14, 17V4/6/8/10/12/14/16, 18V4/6/8/10/12, 19V4/6/10, 27V4/6/8/10/12/14, 28V4/6/8/10/12/14/16, 29V4/6/8/10/12, 30V4/6/10	Phoenix contact	44
35.	PID controller	34U2	Pepperl+Fuchs	1
36.	Quint diode	2G15	Phoenix contact	1

All components model no. shall be added.



Nr	Description	Tagnumber	Make	Qty
X0	Terminal strip	X0....	Weidmuller	9
X1	Terminal strip	X1....	Weidmuller	10
X2	Terminal strip	X2....	Weidmuller	20
X3	Terminal strip	X3....	Weidmuller	8
X4	Terminal strip	X4....	Weidmuller	16
X5	Terminal strip	X5....	Weidmuller	26
X8	Terminal strip	X8....	Weidmuller	20
X9	Terminal strip	X9....	Weidmuller	9
X10	Terminal strip	X10....	Weidmuller	4
X11	Terminal strip	X11....	Weidmuller	4

GENERAL NOTES
 1. Tag numbers correspond with electrical diagram
 2. All the parts that are on the list in the panel layout will be included in the IOM.

REFERENCE DRAWINGS	DWG.No.
xxxxxxx	xxxxxxx

REV.	DATE	PURPOSE OF ISSUE (P.O.I.)	PREP.	CHKD.	APPR.	AC.
02	15/06/22	For approval	BK	RB	RB	-
01	18/10/21	For approval	HT	RB	RB	-
00	24/11/20	For approval	HT	RB	RB	-

Modify the MC logo

OWNER:  MC:  CONTRACTOR: 

PROJECT: BUSHEHR PETROCHEMICAL COMPANY
MEG PLANT

DRAWING TITLE: 17811-07B
 BUSHEHR PETROCHEMICAL COMPANY
 GENERAL ARRANGEMENT DRAWING & TERMINAL DETAILS FOR EMERGENCY INSTRUMENT AIR COMPRESSOR

CONTRACT NO.	SCALE	SIZE	CLASS	PHASE
52-98/445	XX	A0	1	P

DOCUMENT NO.	PROJECT	AREA	PHASE	MIRQ No.	DIS.	DOC.	SEQ.	SHEET	REV. NO.
BU-20-VD-303-IN-0089	BU-20-VD	303-IN	DWG	0089	1	6	02		

UCP-C7080-01

FRONT SIDE (OUTSIDE) VIEW

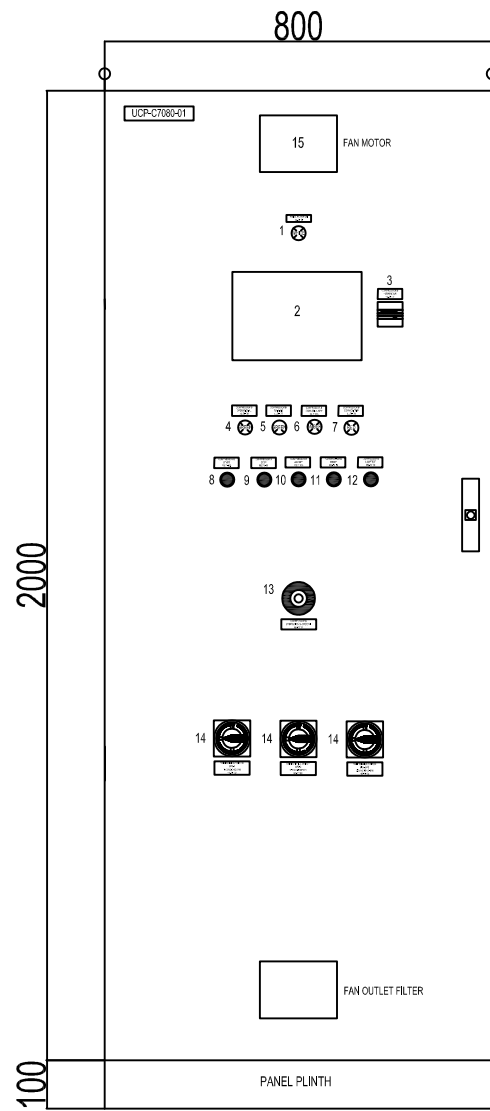

FRONT SIDE (INSIDE) VIEW

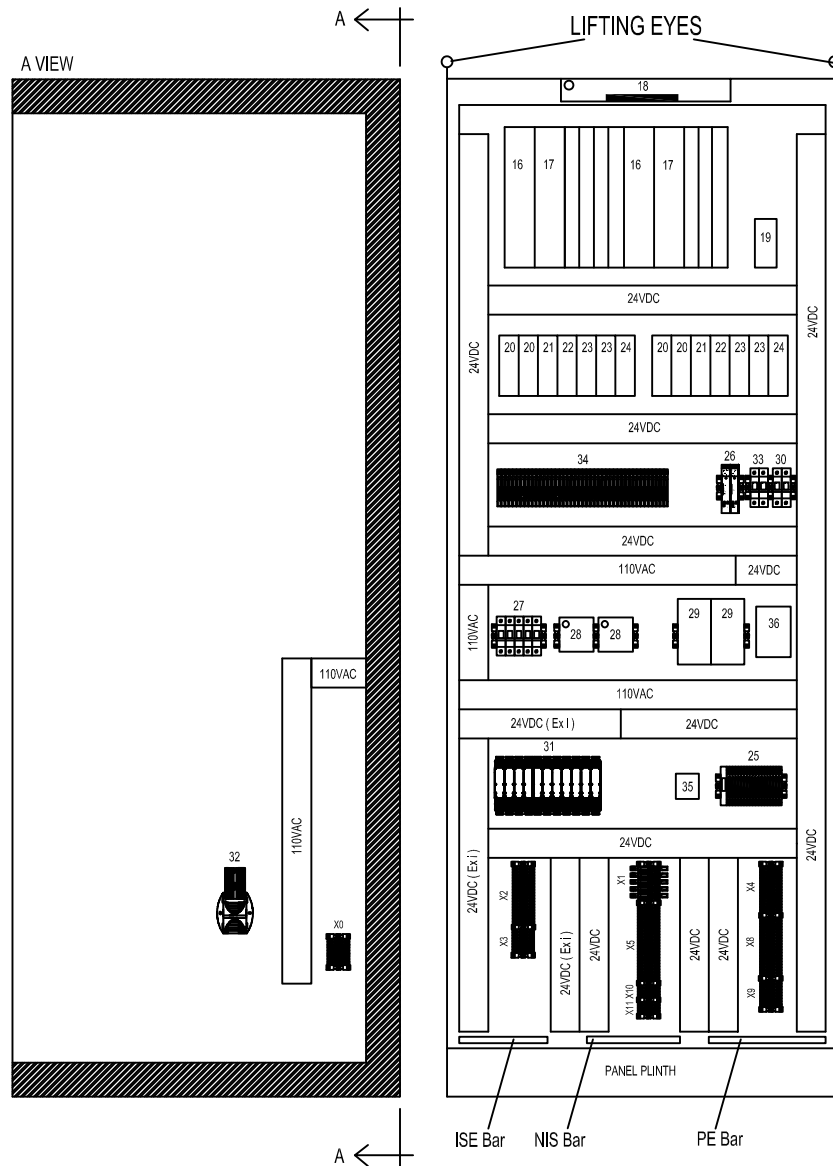

SIDE (OUTSIDE) VIEW

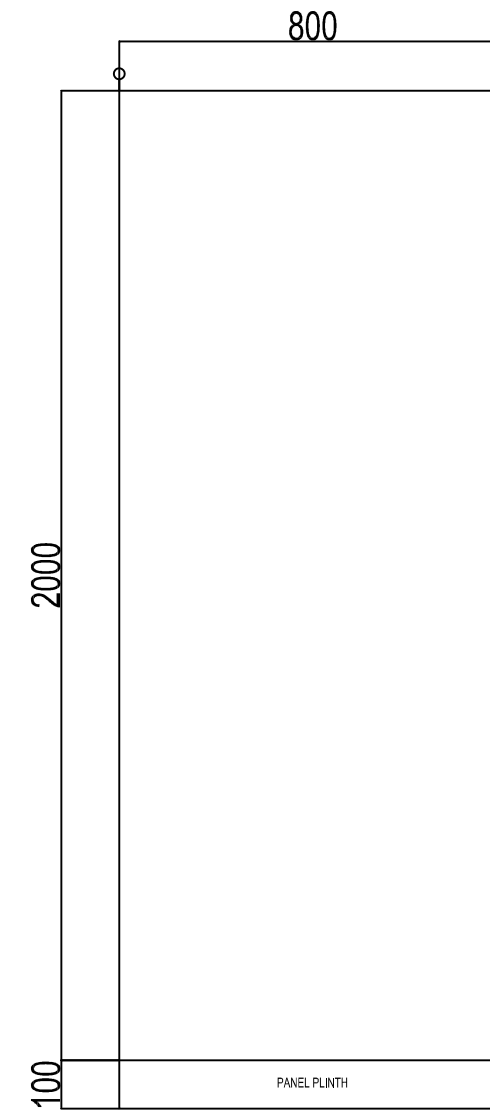

GENERAL NOTES

1. Panel material: Painted sheet steel (RAL7035)
2. Ingress protection: IP-42
3. Panel dimensions: 2100x800x800 mm
4. Area classification: Safe area
5. Drawing pocket will be included: (A3 format)

REFERENCE DRAWNGS	DWG.No.
XXXXXXXX	XXXXXXXX

Nameplate for UCP panel

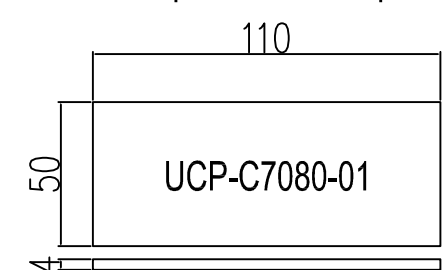

Nameplate for components on panel door (Typical)

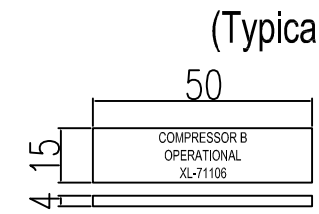

PLINTH FIXING HOLES

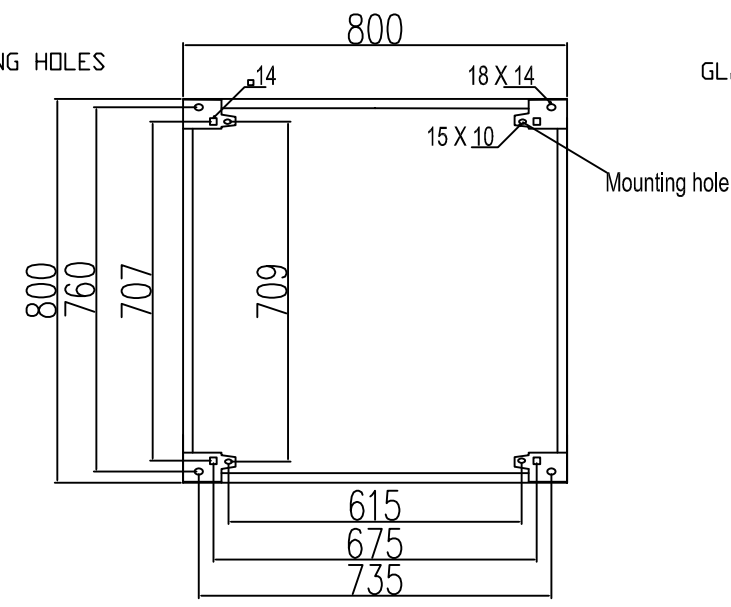

GLAND PLATE MOUNTING DETAILS

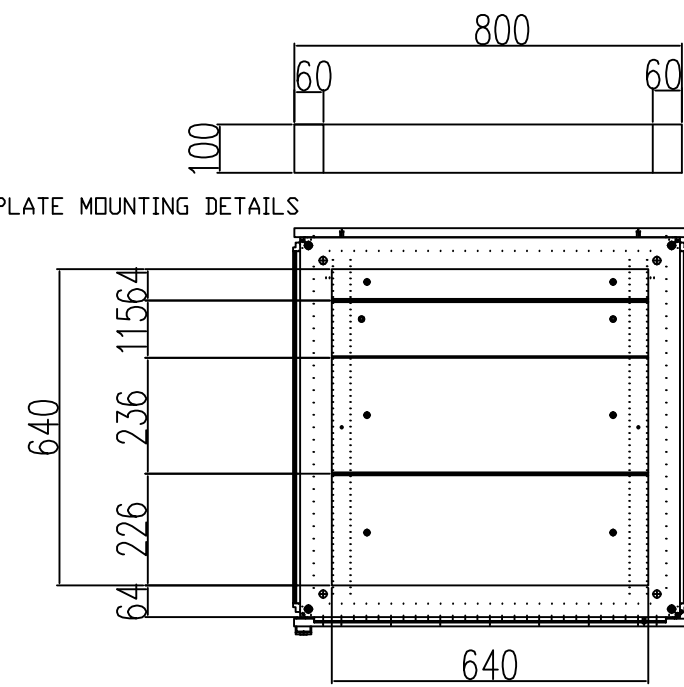

REV.	DATE	PURPOSE OF ISSUE (P.O.I.)	PREP.	CHKD.	APPR.	AC.
03	15/06/22	For approval	BK	RB	RB	-
02	14/12/21	For approval	HT	RB	RB	-
01	18/10/21	For approval	HT	RB	RB	-
00	24/11/20	For approval	HT	RB	RB	-

OWNER:

MC:

CONTRACTOR:

PROJECT: BUSHEHR PETROCHEMICAL COMPANY
MEG PLANT

DRAWING TITLE: 17811-07B
UCP/OP/B GENERAL ARRANGMENT DRAWING & TERMINAL DETAILS FOR EMERGENCY INSTRUMENT AIR COMPRESSOR

CONTRACT NO.	SCALE	SIZE	CLASS	PHASE
52-98/445	XX	A0	1	P

DOCUMENT NO.	PROJECT	AREA	PHASE	MIRQ No.	DIS.	DOC.	SEQ.	SHEET	REV. NO.
OWNER DOC. NO.: BU-20-VD-303-IN-DWG-0089	BU-20-VD-303-IN-DWG-0089							2 OF 6	03

JNDX-C7080-01

FRONT SIDE (OUTSIDE) VIEW

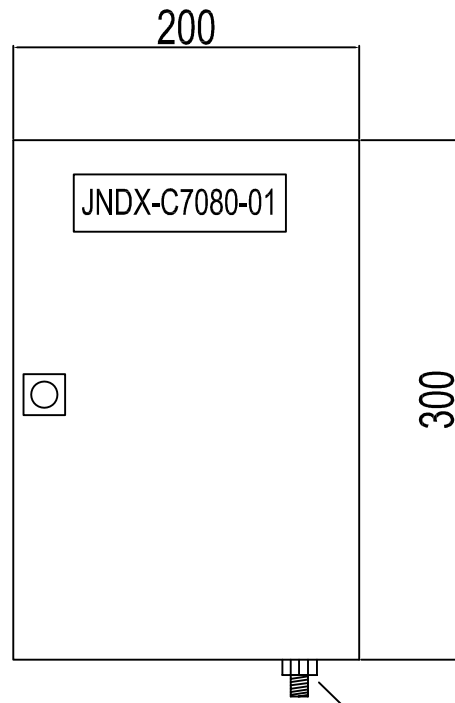

EARTHING BOSS M10

FRONT SIDE (INSIDE) VIEW

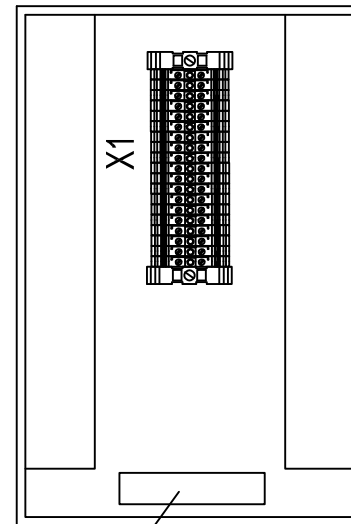

PE Bar

EARTHING BOSS M10

According to your TQ, we accepted that you using Eex 'e' JB, so color of Eex 'e' JB shall be RAL 6021.

Repeated Comment

Required data as per attached file (in previous rev.) was not implemented. (such as name plate, special label and etc.)

155

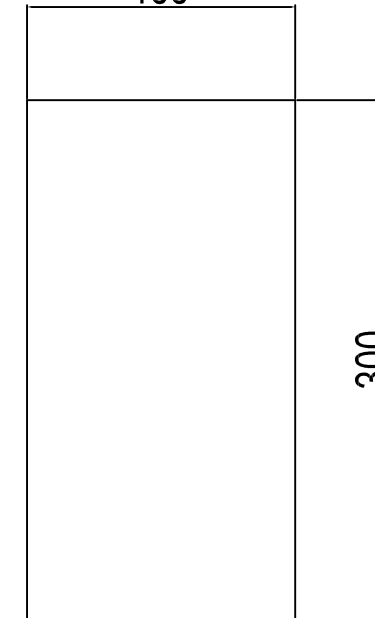

EARTHING BOSS M10

- GENERAL NOTES
1. Panel material: SS316
 2. Ingress protection: IP-65
 3. Panel dimensions: 200x300x155 mm
 4. Area classification: Eex 'e' (RAL 9006) Gray
 5. All spare holes are plugged with certified plugs

REFERENCE DRAWINGS	DWG.No.
XXXXXXXX	XXXXXXXX

BOTTOM VIEW

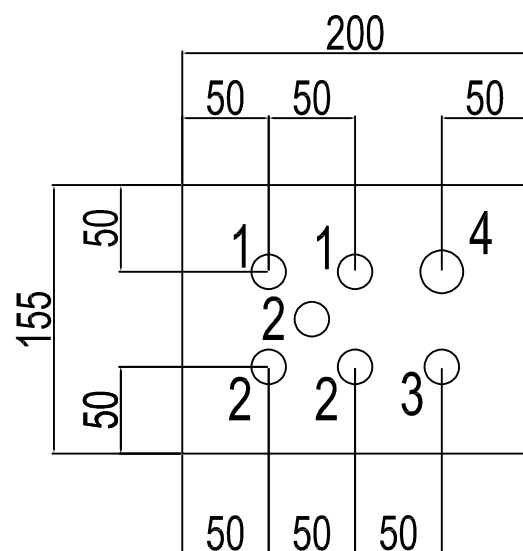

- 1 = Solenoid cable - M20
- 2 = Spare plug - M20
- 3 = Breather / Drain - M20
- 4 = Solenoid multipair cable - M25

GLAND ENTRY DETAILS

- M20: 1x (Breather)
- M20: 5x
- M25: 1x

Terminal strip: X1
Make: Weidmuller
Qty: 16

Repeated Comment

This is tag plate that you specified, in addition tag plate, name plate and special label (same as attached file in previous rev.) shall be specified in this document.

Nameplate for junction box
Material: ABS
Black letters on white background

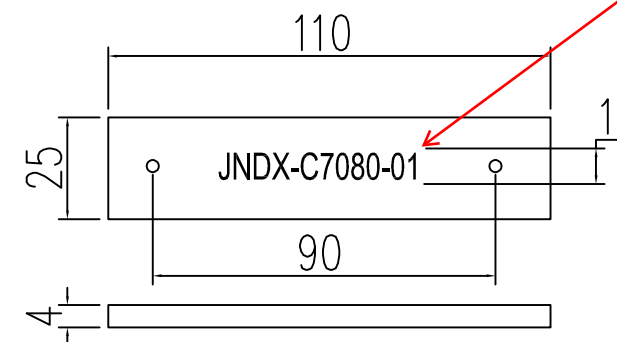

REV.	DATE	PURPOSE OF ISSUE (P.O.I.)	PREP.	CHKD.	APPR.	AC.
03	15/06/22	For approval	BK	RB	RB	-
02	14/12/21	For approval	HT	RB	RB	-
01	18/10/21	For approval	HT	RB	RB	-
00	24/11/20	For approval	HT	RB	RB	-

OWNER:

CONTRACTOR:

PROJECT: BUSHEHR PETROCHEMICAL COMPANY
MEG PLANT

DRAWING TITLE: 17811-07B

CONTRACT NO.	SCALE	SIZE	CLASS	PHASE					
52-98/445	XX	A0	1	P					
DOCUMENT NO.	PROJECT	AREA	PHASE	MIRQ No.	DIS.	DOC.	SEQ.	SHEET	REV. NO.
BU-20-VD-303-IN-0089	BU-20-VD-303-IN	DWG-0089	3 OF 6	03					

JIAX-C7080-01

FRONT SIDE (OUTSIDE) VIEW

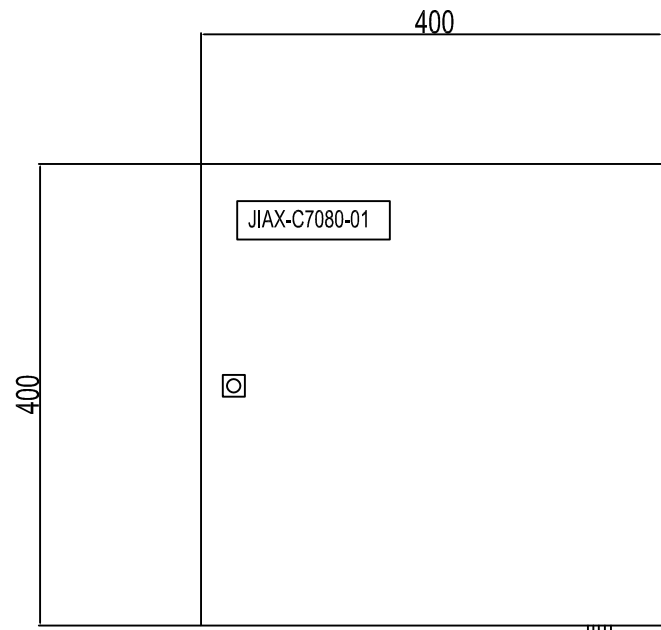

EARTHING BOSS M10

FRONT SIDE (INSIDE) VIEW

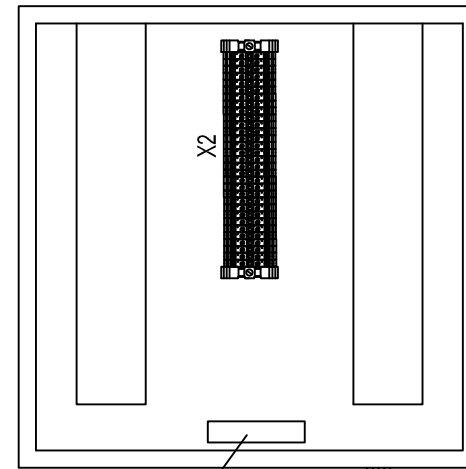

ISE Bar

EARTHING BOSS M10

SIDE (OUTSIDE) VIEW

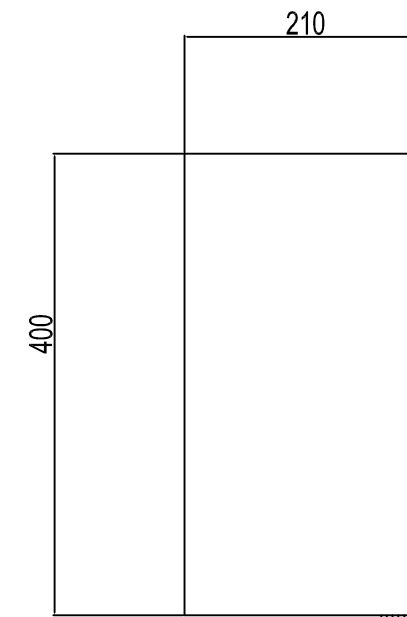

EARTHING BOSS M10

BOTTOM VIEW

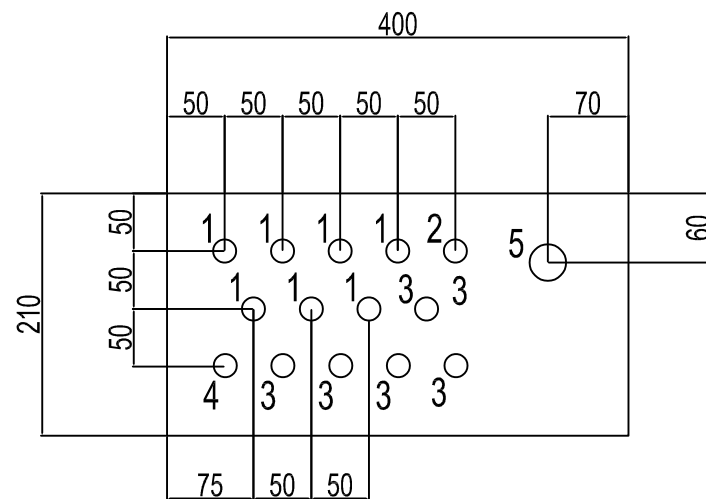

GLAND ENTRY DETAILS

- M20: 1x (Breather)
- M20: 13x
- M32: 1x

- 1 = Transmitter cable - M20
- 2 = PCV cable - M20
- 3 = Spare plug - M20
- 4 = Breather / Drain - M20
- 5 = Transmitter/PCV multipair cable - M32

Terminal strip: X2
Make: Weidmuller
Qty: 31

Nameplate for junction box
Material: ABS
Black letters on white background

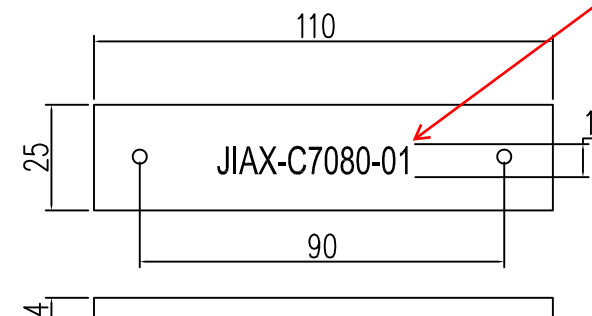

GENERAL NOTES

1. Panel material: SS316
2. Ingress protection: IP-65
3. Panel dimensions: 400x400x210 mm
4. Area classification: Eex 'i' (RAL 5015) Blue
5. All spare holes are plugged with certified plugs

REFERENCE DRAWINGS

XXXXXXXX

DWG.No.

XXXXXXXX

Repeated Comment
This is tag plate that you specified, in addition tag plate, name plate and special label (same as attached file in previous rev.) shall be specified in this document.

REV.	DATE	PURPOSE OF ISSUE (P.O.I.)	PREP.	CHKD.	APPR.	AC.
03	15/06/22	For approval	HT	RB	RB	-
02	14/12/21	For approval	HT	RB	RB	-
01	18/10/21	For approval	HT	RB	RB	-
00	24/11/20	For approval	HT	RB	RB	-

OWNER:

MC:

CONTRACTOR:

PROJECT: BUSHEHR PETROCHEMICAL COMPANY
MEG PLANT

DRAWING TITLE: 17811-07B
UCP/OP/IB GENERAL ARRANGEMENT DRAWING & TERMINAL DETAILS FOR EMERGENCY INSTRUMENT AIR COMPRESSOR

CONTRACT NO.	SCALE	SIZE	CLASS	PHASE
52-98/445	XX	A0	1	P

DOCUMENT NO.	PROJECT	AREA	PHASE	MIRQ No.	DIS.	DOC.	SEQ.	SHEET NO.	REV. NO.

OWNER DOC. NO.: BU-20-VD-303-IN-DWG-0089 4 OF 6 03

LP-C7080-01

FRONT SIDE (OUTSIDE) VIEW

FRONT SIDE (INSIDE) VIEW

According to your TQ, we accepted that you using Eex 'e' JB, so color of Eex 'e' JB shall be RAL 6021.

- GENERAL NOTES
1. Panel material: SS316
 2. Ingress protection: IP-65
 3. Panel dimensions: 400x400x210 mm
 4. Area classification: Eex 'e' (RAL 9006) Gray
 5. All spare holes are plugged with certified plugs
 6. Additional information processed in the nameplate:
 - Protection degree panel
 - Permissible withstanding short circuit current
 - Total weight panel
 - Insulation voltage panel
 - Manufacturer date
 - Panel tag

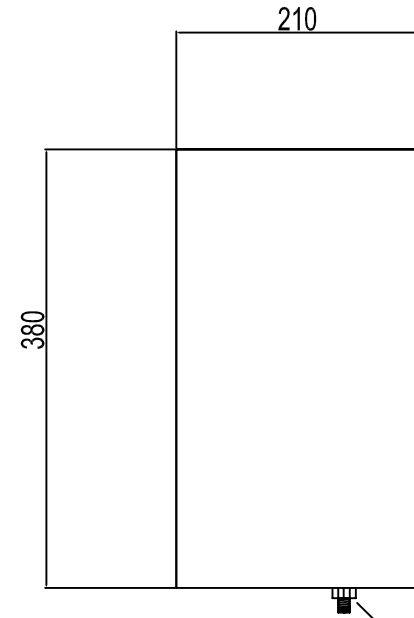
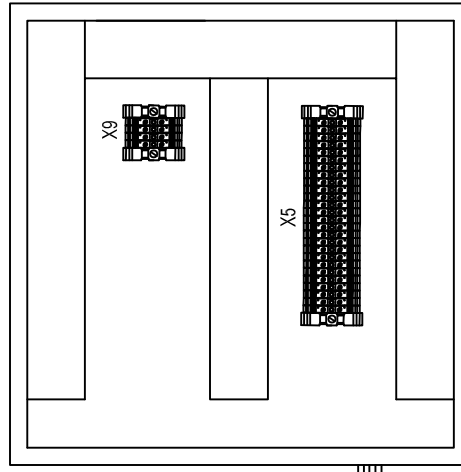
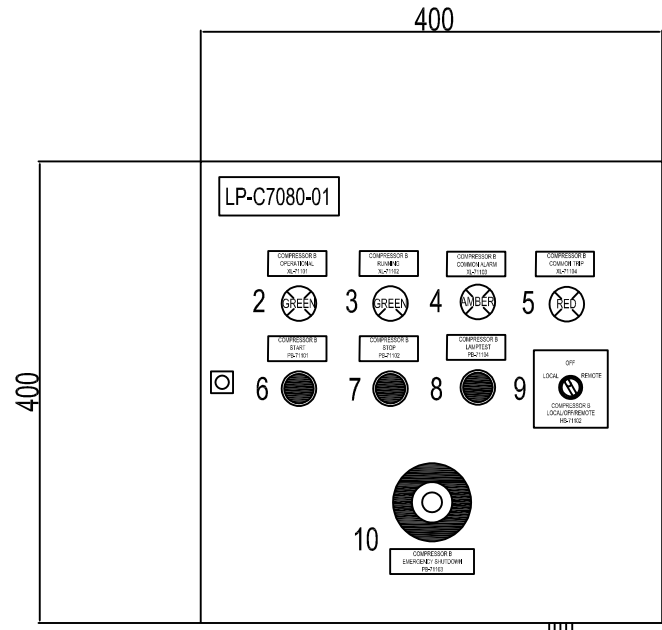

EARTHING BOSS M10

EARTHING BOSS M10

EARTHING BOSS M10

BOTTOM VIEW

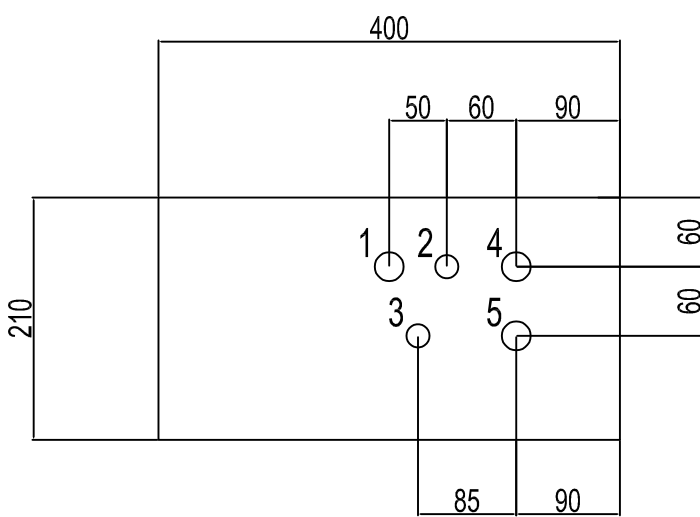

GLAND ENTRY DETAILS

- M20: 1x (Breather)
- M20: 1x
- M25: 3x

- 1 = ESD multicore cable - M25
- 2 = Spare plug - M20
- 3 = Breather / Drain - M20
- 4 = Pushbutton / Lamps multicore cable - M25
- 5 = Spare plug - M25

Nameplate for junction box
Material: ABS
Black letters on white background

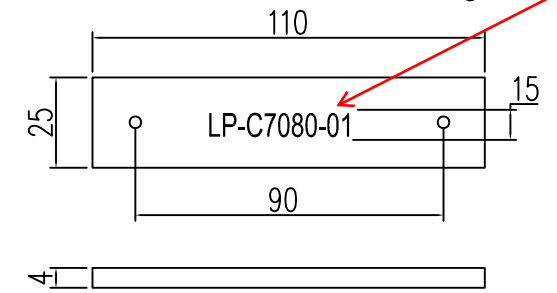

Nameplate for components on JB door (Typical)

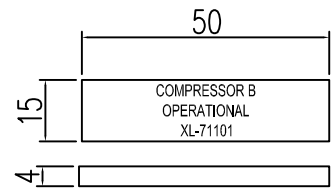

Nameplate for junction box
Material: ABS
Black letters on white background

Repeated Comment
This is tag plate that you specified, in addition tag plate, name plate and special label (same as attached file in previous rev.) shall be specified in this document.

REV.	DATE	PURPOSE OF ISSUE (P.O.I.)	PREP.	CHKD.	APPR.	AC.
03	15/06/22	For approval	BK	RB	RB	-
02	14/12/21	For approval	HT	RB	RB	-
01	18/10/21	For approval	HT	RB	RB	-
00	24/11/20	For approval	HT	RB	RB	-

OWNER:	MC:	CONTRACTOR:
PROJECT: BUSHEHR PETROCHEMICAL COMPANY MEG PLANT		
DRAWING TITLE: 17811-07B		
CONTRACT NO. 52-98/445		
SCALE: XX	SIZE: A0	CLASS: 1
PHASE: P	PHASE: P	PHASE: P
DOCUMENT NO.	PROJECT AREA	PHASE MRO No.
DIS.	DOC.	SEQ.
SHEET	REV. NO.	REV. NO.
OWNER DOC. NO.: BU-20-VD-303-IN-008	BU-20-VD-303-IN-DWG-0089	6 OF 6