







OWNER 	<b>BUSHEHR PETROCHEMICAL COMPANY MEG PLANT</b>							EPC CONTRACTOR:  Chagalesh-Enerchimi-Steam Joint Venture BEPC-MEG PLANT PROJECT	
	<b>NDE procedure for reciprocating compressor</b>								
MC :  	Project	Area	Phase	Unit	Dis.	Doc.	Seq.	Contract No : 52-98/445	
Owner Document Number: 17811-15	BU	20	VD	303	QC	PRC	0007	Rev.:	Page
								00	1 of 20





**General Comment:**

1. RT and UT procedures shall be added.
2. NDT map shall be added.
3. For this procedure and UT and RT procedure shall be considered all ASME SEC. V requirement so this standard shall be added in reference sections.
4. All NDT format reports shall be added.

## NDE procedure for reciprocating compressor

	<b>BUSHEHR PETROCHEMICAL COMPANY MEG PLANT</b>
<b>Document Review</b>	
Issue Purpose:	IFA
Result Code: AP,AN,CM,RE,NC	CM
Next Status : IFC,IFA,IFI,AFC,AB,IFR	IFA
Responsible Department	INSPECTION
Commented Date	<u>6/12/2021</u>
<b>Approval or review hereunder shall not be construed to relieve Vendor / Subcontractor of his responsibilities and liability under the contract.</b>	

00	08/12/2020	For approval	KP	KP	PW	
Rev.	Date	Purpose of Issue	Prepared	Checked	Approved	AC Code
Class: 1						Phase: 1p

OWNER  شرکت پتروشیمی بوشهر	<b>BUSHEHR PETROCHEMICAL COMPANY MEG PLANT</b>						EPC CONTRACTOR: 		
	<b>NDE procedure for reciprocating compressor</b>								
MC :   شرکت سمیت و سویی توسعه ایرانیان	Project	Area	Phase	Unit	Dis.	Doc.	Seq.	Contract No : 52-98/445	
Owner Document Number: 17811-15	BU	20	VD	303	QC	PRC	0007	Rev.:	Page
								00	2 of 20

### TABULATION OF REVISED PAGES

Page	D00	D01	D02	D03	D04
1.	X				
2.	X				
3.	X				
4.	X				
5.	X				
6.	X				
7.	X				
8.	X				
9.	X				
10.	X				
11.	X				
12.	X				
13.	X				
14.	X				
15.	X				
16.	X				
17.	X				
18.	X				
19.	X				
20.	X				
21.					
22.					
23.					
24.					
25.					
26.					
27.					
28.					
29.					
30.					
31.					
32.					
33.					
34.					

Page	D00	D01	D02	D03	D04
35.					
36.					
37.					
38.					
39.					
40.					
41.					
42.					
43.					
44.					
45.					
46.					
47.					
48.					
49.					
50.					
51.					
52.					
53.					
54.					
55.					
56.					
57.					
58.					
59.					
60.					
61.					
62.					
63.					
64.					
65.					
66.					
67.					
68.					

Doc Ref : MT 19108  
 Revision : 0  
 Date : 20-12-2019  
 Title : Magnetic testing procedure  
 Client : Airpack Nederland B.V.

## MAGNETIC TESTING PROCEDURE

Client : Airpack Nederland B.V.

Purpose of the examination : Magnetic particle inspection of welds.

Method : According to AWS D1.1 / D1.1M: 2015 (ASTM E709)

Issued by : Applus RTD BUA NL

Development – Revisions					
Revision no.	Prepared by	Date	Approved by	Date	Amendment details
0	Kevin Cocquyt	20-12-2019	Vincent Spieringhs	20-12-2019	

 Applus+ RTD ND Testing Kevin Cocquyt MT L3: N40004		 Applus+ RTD ND Testing V. Spieringhs			
Date	20-12-2019	Date	20-12-2019	Date	

Address  
 Delftweg 144, 3046 NC Rotterdam  
 P.O. Box 10065, 3004 AB Rotterdam  
 The Netherlands  
 www.ApplusRTD.com

This publication is the intellectual property of Applus+ RTD and may not be used in whole or in part for any purpose other than the business of Applus+ RTD and may not be used for the business of the recipient and may not be passed to any other person without the permission of Applus+ RTD.

## Contents

<b>1</b>	<b>Scope</b>	<b>3</b>
<b>2</b>	<b>Referenced documents</b>	<b>3</b>
2.1	<i>Applus+ RTD documents</i>	3
2.2	<i>Codes and standards</i>	3
2.3	<i>Abbreviations</i>	3
<b>3</b>	<b>General requirements</b>	<b>4</b>
3.1	<i>Personnel qualifications</i>	4
3.2	<i>Safety precautions</i>	4
3.3	<i>Surface preparation</i>	4
3.4	<i>Surface temperature</i>	4
3.5	<i>Identification and datum position</i>	5
3.6	<i>Viewing conditions</i>	5
<b>4</b>	<b>Equipment and consumables</b>	<b>5</b>
4.1	<i>Yokes</i>	5
4.2	<i>Light meters</i>	5
4.3	<i>Examination consumables</i>	5
<b>5</b>	<b>Examination</b>	<b>7</b>
5.1	<i>Examination method</i>	7
5.2	<i>Direction of magnetization</i>	7
5.3	<i>Extent of examination</i>	7
5.4	<i>Demagnetization</i>	7
5.5	<i>Post examination cleaning</i>	7
<b>6</b>	<b>Evaluation of indications</b>	<b>8</b>
<b>7</b>	<b>Acceptance standard</b>	<b>8</b>
7.1	<i>Choice of acceptance criteria</i>	8
7.2	<i>Acceptance criteria</i>	9
<b>8</b>	<b>Report</b>	<b>10</b>

## 1 Scope

This procedure describes the method and acceptance criteria to be used for magnetic testing on structural steel skids with AC yoke magnetisation. To be performed in conformity with the requirements of;

- AWS D1.1/D1.1M:2015 (ASTM E709)

## 2 Referenced documents

### 2.1 *Applus+ RTD documents*

NL-10	Written practice for the Training, Qualification, Certification and Authorization of NDT Personnel
CP 31201	Verification procedure for electric magnetic yokes
CP 31203	Verification procedure for magnetic particle suspensions
CP 31210	Verification procedure of light intensity meters

### 2.2 *Codes and standards*

ISO 9712	Qualification and certification of NDT personnel
SNT TC 1A: 2006	Personnel qualification and certification in NDT
AWS D1.1/D1.1M:2015 (ASTM E709)	Magnetic particle Examination
AWS D1.1/D1.1M:2015	Acceptance standard for magnetic particle examination

### 2.3 *Abbreviations*

AC	Alternating Current
HSE	Health Safety and Environment
kg	kilogram
MT	Magnetic Testing
NDE	Non Destructive Examination
CJP	Complete Joint Penetration
°C	Temperature in degree Celsius
mm	Millimetre
<	Less than
≥	Greater than or equal to
CJP	Complete joint penetration
NA	Not applicable

### 3 General requirements

#### 3.1 Personnel qualifications

NDE - personnel shall be qualified and certified in accordance with the valid version of Applus+ RTD written practice, which is in conformity with the recommended practice SNT-TC-1A and ISO 9712, level MT 2 as minimum.

#### 3.2 Safety precautions

All applicable HSE laws and regulations and the HSE rules of our customers shall be observed at all times. Furthermore Applus+ RTD develops its own HSE rules.

In case of conflict between rules and regulations, the strictest will prevail.  
Special consideration shall be given to:

- inflammable and/or volatile materials;
- contrast paint and aerosols as used in magnetic testing;
- Extra attention at magnetic testing on hot objects > 50°C.

Use of safety gloves and eye protection is recommended.

#### **Note:**

The vapors from the consumables may be hazardous. Proper ventilation shall be provided in the case of testing being performed in a confined space. At no time during examination, shall there be exposure to any naked flames or sparks due to the flammable nature of the materials.

The use of aerosol containers and dry powders in confined spaces is dangerous and therefore it is only permitted in accordance with the Applus+ RTD safety pocketbook "working in confined spaces".

#### 3.3 Surface preparation

Prior to the magnetic examination the surface or weld surface plus at least 25 mm on both sides of the weld, shall be dry and free of dirt, grease, coating, preserving, scale, welding flux, weld spatter, oil and other matter, that could obscure surface openings or otherwise interfere with the examination.

Typical cleaning agents which may be used are detergents, organic solvents, de-scaling solutions, and paint removers. Degreasing and ultrasonic cleaning methods may also be used.

Surface preparation by grinding or machining may be necessary where surface irregularities could mask indications or produce false indications.

#### 3.4 Surface temperature

The surface temperature of the part to be examined (only for the "wet method") shall be within the temperature range limitations set by the manufacturer of the particles.

##### 3.4.1 High temperature

If the (surface) temperature is > 50°C suitable consumables shall be used.

### *3.5 Identification and datum position*

The welds shall be identified in accordance with the client's requirements.

The marking of flaw indications on the tested component shall be considered necessary as the resultant indications found at the time of inspection cannot be considered permanent. The position of flaws shall be marked on the tested component by a method that will not affect the use of the component or prejudice any subsequent testing.

### *3.6 Viewing conditions*

At all times during the examination with the non-fluorescent method, the light intensity at the surface to be examined shall be 1000 lux. as a minimum.

## **4 Equipment and consumables**

### *4.1 Yokes*

An AC magnet Yoke shall be used.

The lifting power shall be checked prior to examination, and shall be 4.5 kg as minimum at the maximum pole spacing that will be used.

The verification of the yoke shall be done once a year or whenever the yoke has been damaged or repaired, in accordance with procedure Applus+ RTD CP 31201.

A field indicator (e.g. Berthold field indicator) may be used, if necessary, to determine the field direction.

### *4.2 Light meters*

Light meters shall be calibrated at least once a year (12 month period +/- 2 weeks) or whenever the meter has been repaired. If meters have not been in use for one year or more, calibration shall be done before being used.

The light meters have to be verified, according to Applus+ RTD verification procedure CP 31210.

### *4.3 Examination consumables*

The examination consumables to be used must provide sufficient contrast with the surface to be examined. The examination medium shall be supplied by Applus+ RTD.

The preferred examination consumables are given on page 6; other products may be used after approval by Applus+ RTD level 3 specialist.

#### 4.3.1 Black particles (wet method)

The magnetic particles, black and fluorescent, to be used in the examination shall meet the following requirements:

- Are oil or water suspended;
- The colour of the particles shall be such as to provide an adequate contrast with the surface being examined;
- The examination consumables shall be agitated (shaken) properly, as per manufacturers' recommendation, to ensure that the dispersion of particles is equal throughout the entire use of the containers contents.
- The test medium shall be applied by either flowing or spraying over the surface. The force of the application shall be such that weakly formed indications are not disturbed or removed.

Wet particles: MR Chemie:

<u>Type</u>	<u>Product</u>	<u>Temp. range</u>	<u>Suspension</u>
• MR 76 SAS	Magnetic testink (black)	+5° to +50°C	Oil based
• MR 221 GF	Magnetic testink (black)	+5° to +50°C	Water based

These wet particles have been tested by the manufacturer for conformity. Where necessary the examination medium will be tested in accordance with verification procedure Applus+ RTD CP 31203.

#### 4.3.2 Contrast paint

If the contrast between the surface and the examination medium is too low, a very thin contrast paint layer shall be applied to the surface.

The preferred contrast paint is given below; other contrast paint may be used after approval by Applus+ RTD level 3 specialist.

<u>Type</u>	<u>Product</u>	<u>Temp. range</u>	<u>Suspension</u>
• MR 72	White contrast paint	+5° to +50°C	
• MR 721	White contrast paint	+5° to +50°C	Water based

## 5 Examination

### 5.1 Examination method

The magnetic particles used in an examination (wet or dry) shall be applied by the continuous method: The magnetizing current shall remain on while the examination medium is being applied and while excess of the examination medium will flow away, or the dry powder will be softly blown away. Following this, time shall be allowed for indications to form before removal of the magnetic field.

### 5.2 Direction of magnetization

To ensure detection of imperfections in all orientations, the area shall be magnetized in two directions approximately perpendicular to each other.

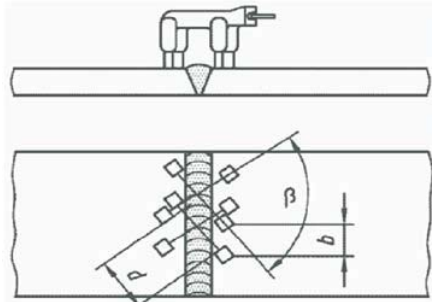

$d \geq 75$ ,  $b \leq 2d$  and  $\beta = 90^\circ$

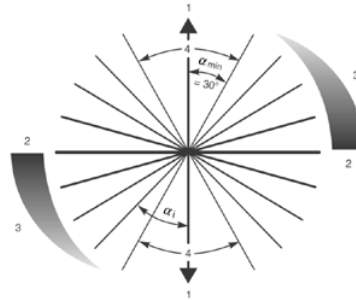

$\alpha$  = is the angle between the magnetic field and the direction of the imperfection  $\alpha_{\min}$  = is the minimum angle for imperfection detection.  $\alpha_1$  = is an example of imperfection orientation.  
1 = magnetic field direction, 2 = optimum sensitivity,  
3 = reducing sensitivity and 4 = insufficient sensitivity

### 5.3 Extent of examination

The examination has to be executed in such a manner that there is sufficient overlap to ensure that 100% examination has been executed.

### 5.4 Demagnetization

The examined areas shall not be demagnetized after examination.

After testing with AC current, residual magnetization will normally be low and generally there is no need for demagnetization of the tested object.

### 5.5 Post examination cleaning

The examined areas shall not be cleaned after examination.

## 6 Evaluation of indications

The evaluation of indications shall be done during the magnetization.

An indication of an imperfection may be larger than the real imperfection. However the size of the indication will be the basis for the evaluation.

A linear indication is an indication (piping porosity), of which the length is larger than 3 times the width.

A rounded (non-linear) indication (porosity) is an indication of circular- and/or elliptical shape with a length equal to or less than 3 times its width.

**Note:**

Not all of the indications are relevant, because excessive surface roughness, etc. may cause similar indications. Any questionable indications shall be re-examined, possibly after surface improvement, to determine whether or not it is relevant.

## 7 Acceptance standard

### 7.1 *Choice of acceptance criteria*

The client shall provide the load condition and load direction before examination.

Required info:

Statically loaded or cyclically loaded.

Tensile stress during any load condition: Yes or No.

When the load condition is unknown the used acceptance shall be cyclically loaded with tensile stress.

## 7.2 Acceptance criteria

Acceptance according AWS D1.1: 2015 Claus 6. Table 6.1 and Clause 9, Table 9.6.

Discontinuity Category and Inspection Criteria	Table 6.1		Table 9.6
	Statically Loaded Nontubular Connections	Cyclically Loaded Nontubular Connections	Tubular Connections (All Loads)
1) Crack Prohibition <i>Any crack shall be unacceptable, regardless of size or location.</i>	X	X	X
(2) Weld/Base Metal Fusion <i>Complete fusion shall exist between adjacent layers of weld metal and between weld metal and base metal.</i>	X	X	X
(7) Undercut <i>A) For material less than 1 in [25 mm] thick, undercut shall not exceed 1/32 in [1 mm], with the following exception: undercut shall not exceed 1/16 in [2 mm] for any accumulated length up to 2 in [50 mm] in any 12 in [300 mm]. For material equal to or greater than 1 in [25 mm] thick, undercut shall not exceed 1/16 in [2 mm] for any length of weld.</i> <i>(B) In primary members, undercut shall be no more than 0.01 in [0.25 mm] deep when the weld is transverse to tensile stress under any design loading condition. Undercut shall be no more than 1/32 in [1 mm] deep for all other cases.</i>	X	NA	NA
(8) Porosity <i>(A) CJP groove welds in butt joints transverse to the direction of computed tensile stress shall have no visible piping porosity. For all other groove welds and for fillet welds, the sum of the visible piping porosity 1/32 in [1 mm] or greater in diameter shall not exceed 3/8 in [10 mm] in any linear inch of weld and shall not exceed 3/4 in [20 mm] in any 12 in [300 mm] length of weld.</i> <i>(B) The frequency of piping porosity in fillet welds shall not exceed one in each 4 in [100 mm] of weld length and the maximum diameter shall not exceed 3/32 in [2.5 mm]. Exception: for fillet welds connecting stiffeners to web, the sum of the diameters of piping porosity shall not exceed 3/8 in [10 mm] in any linear inch of weld and shall not exceed 3/4 in [20 mm] in any 12 in [300 mm] length of weld.</i> <i>(C) CJP groove welds in butt joints transverse to the direction of computed tensile stress shall have no piping porosity. For all other groove welds, the frequency of piping porosity shall not exceed one in 4 in [100 mm] of length and the maximum diameter shall not exceed 3/32 in [2.5 mm].</i>	X	NA	NA
	NA	X	X
	NA	X	X

***Discontinuities 3, 4, 5 and 6 shall only be subject to visual inspection.***

***Discontinuities 2, 7 and 8 shall only be evaluated on length in case of an MPI indication and shall not be evaluated on other dimensions.***

***X shall be evaluated***

***NA shall not be evaluated***

## 8 Report

For each magnetic examination carried out a report shall be written. Each report shall contain the following information as minimum:

- Procedure number and revision;
- Examination standard, acceptance standard;
- Client;
- Date of examination;
- Equipment used and type of current;
- Magnetic particles used incl. batch numbers ( wet or dry);
- Object data and examined parts;
  - base material;
  - extent of examination
  - in case of welds type of weld, welding process and filler material;
  - heat treatment (if applicable);
  - thickness;
  - temperature of the object;
- Viewing conditions(light intensity);
- Drawing or record of all indications exceeding the acceptance standard;
  - All relevant indications shall be reported with as minimum the type, location and extent (length, diameter or aligned);
- Name operator(s) qualification and signature operator(s) who performed examination.

Doc Ref : PT 21315  
 Revision : 1  
 Date : 27-02-2020  
 Title : Liquid Penetrant Examination  
 Type : Standard Procedure



## LIQUID PENETRANT EXAMINATION PROCEDURE

By using:

**Solvent or water removable penetrant**

The examination and assessment is in accordance with:

**ASME B31.3 – 2018, Process Piping, ASME code for Pressure Piping, B31**

Development – Revisions					
Revision No.	Prepared By	Date	Approved By	Date	Amendment Details
1	T. Cornelissen	27-02-2020	N. Nuijten	27-02-2020	Complete revised to ASME B31.3 – 2018, Process Piping, ASME code for Pressure Piping, B31.
0		29-03-2017			
 <b>Applus+ RTD</b> NDT L3 N. Nuijten					
Date:	27-02-2020	Date:	27-02-2020	Date:	

Address  
 Delftweg 144, 3046 NC Rotterdam  
 P.O. Box 10065, 3004 AB Rotterdam  
 The Netherlands  
[www.ApplusRTD.com](http://www.ApplusRTD.com)

This publication is the intellectual property of Applus+ RTD and may not be used in whole or in part for any purpose other than the business of Applus+ RTD and may not be used for the business of the recipient and may not be passed to any other person without the permission of Applus+ RTD.

Contents

<b>1</b>	<b>Scope</b>	<b>3</b>
<b>2</b>	<b>Referenced documents</b>	<b>3</b>
2.1	<i>Applus+ RTD documents</i>	3
2.2	<i>Codes and standards</i>	3
2.3	<i>Abbreviations</i>	3
<b>3</b>	<b>Safety Precautions</b>	<b>3</b>
<b>4</b>	<b>Personnel qualifications</b>	<b>4</b>
<b>5</b>	<b>Equipment and consumables</b>	<b>4</b>
5.1	<i>Consumables</i>	4
5.2	<i>Light meters</i>	4
5.3	<i>Black light</i>	4
<b>6</b>	<b>Examination</b>	<b>5</b>
6.1	<i>Surface condition</i>	5
6.2	<i>Temperature</i>	5
6.3	<i>Viewing conditions</i>	5
6.4	<i>Pre-cleaning</i>	5
6.5	<i>Drying</i>	6
6.6	<i>Penetrant application</i>	6
6.7	<i>Dwell-time</i>	6
6.8	<i>Excess penetrant removal</i>	6
6.9	<i>Drying</i>	6
6.10	<i>Developing</i>	6
6.11	<i>Developing time</i>	7
6.12	<i>Interpretation</i>	7
6.13	<i>Re-examination</i>	7
6.14	<i>Post examination cleaning</i>	7
<b>7</b>	<b>Evaluation of indications</b>	<b>7</b>
<b>8</b>	<b>Acceptance standard</b>	<b>8</b>
<b>9</b>	<b>Records</b>	<b>8</b>

## 1 Scope

This procedure describes the method to be used for solvent removable or water washable, colour contrast and/or fluorescent liquid penetrant examination of austenitic and ferritic material.

The examination and acceptance will be performed in conformity with the requirements of:

- ASME B31.3 – 2018, Process Piping, ASME code for Pressure Piping, B31.

## 2 Referenced documents

### 2.1 *Applus+ RTD documents*

- NL-10 Written practice for the Training, Qualification, Certification and Authorization of NDT Personnel.
- CP 31204 Verification of UV-A light lamps used for NDT.
- CP 31209 Verification procedure for Black ray UV radiometers.
- CP 31210 Verification procedure of light intensity meters.

### 2.2 *Codes and standards*

- ASME B31.3 – 2018 Process Piping, ASME code for Pressure Piping, B31.
- ASME BPVC Section V, Art. 6 Liquid penetrant examination.
- ISO 9712 Qualification and certification of NDT personnel.
- SNT-TC-1A Personnel Qualification and Certification in NDT.

### 2.3 *Abbreviations*

ASME BPVC	ASME Boiler Pressure Vessel code
HSE	Health Safety and Environment
NDE	Non Destructive Examination
PT	Penetrant Testing
°C	Temperature in degree Celsius

## 3 Safety Precautions

All applicable HSE laws and regulations and the HSE rules of our customers shall be observed at all times. Furthermore Applus+ RTD develops its own HSE rules.

In case of conflict between rules and regulations, the strictest will prevail. Special consideration shall be given to:

- inflammable and/or volatile materials;
- liquids and aerosols as used in penetrant testing;
- Extra attention at penetrant testing on hot objects > 50°C.
- Use of safety gloves and eye protection is recommended.

### **Note:**

The vapours from the consumables may be hazardous. Proper ventilation shall be provided in the case of testing being performed in a confined space. At no time during examination, shall there be exposure to any naked flames or sparks due to the flammable nature of the materials.

The use of aerosol containers and dry powder in confined spaces is dangerous and therefore it is only permitted in accordance with the Applus+ RTD safety pocketbook "working in confined spaces".

## 4 Personnel qualifications

NDE-personnel shall be qualified and certified in accordance with the valid version of Applus+ RTD Written Practice, NL-10, which is in conformity with ISO 9712 and SNT-TC-1A.

Trainees and personnel level 1 can be assigned to NDE only under the supervision of personnel level 2 as minimum.

## 5 Equipment and consumables

### 5.1 Consumables

Mix-up of penetrant consumables of various types/brands is not permitted.

The penetrant consumables shall be supplied by Applus+ RTD. This can be a colour contrast or fluorescent liquid penetrant.

The preferred examination fluids are given below.

Other fluids may be used after approval by an Applus+ RTD level 3 specialist.

- MR Chemie MR 68 NF Penetrant Red Colour contrast
- MR Chemie MR 68 H Penetrant Red and Fluorescent hot
- MR Chemie MR 670 F Penetrant Fluorescent
  
- MR Chemie MR 79 Special cleaner
- MR Chemie MR 88 Cleaner
- MR Chemie MR 91 H Cleaner hot
  
- MR Chemie MR 70 Developer white
- MR Chemie MR 70 H Developer white hot
- MR Chemie MR 81 Developer "dry" (only for use at fluorescent)
- MR Chemie MR 703 W Developer white "waterbased"

### 5.2 Light meters

Light Meters, both visible and fluorescent (black) light meters, shall be verified at least once a year according to Applus+ RTD control procedure CP-31210 for visible light meters and CP 31204 for black light meters or whenever the meter has been damaged and/or repaired.

### 5.3 Black light

The black light shall be verified according Applus+ RTD verification procedure CP 31204.

When using filtered black light, care shall be taken to ensure that unfiltered radiation from the black light does not directly reach the eyes of the operators. Whether it forms an integral part of the lamp or is a separate component, the UV-A filter shall always be maintained in good condition.

Ensure that lamps are functioning correctly, are in good condition and that UV-A filters, where fitted, are intact.

## **6 Examination**

### *6.1 Surface condition*

Prior to the examination the surface to be examined and all adjacent areas within at least 25 mm, shall be dry and free of dirt, grease, preserving, scale, welding flux, weld spatter, oil and other matter, that could obscure surface openings or otherwise interfere with the examination.

Typical cleaning agents which may be used are detergents, organic solvents, de-scaling solutions, and paint removers. Degreasing and ultrasonic cleaning methods may also be used.

#### **Caution:**

In all cases and in particular in the case of shot or dull blasting, care shall be taken to ensure that the discontinuities are not masked by deformation of the material.

### *6.2 Temperature*

The temperature of the surface during the examination shall be within the manufactures recommendation and shall be between 5°C and 52°C.

Local heating or cooling is permitted to bring out a temperature between 10°C and 50°C.

#### *6.2.1 Low Temperature*

If the (surface) temperature is < 5°C a separate procedure shall be made and demonstrated that imperfections are detectable.

#### *6.2.2 High temperature*

If the (surface) temperature is > 52°C the suitable penetrant set (hot) shall be used. Examination shall be demonstrated.

### *6.3 Viewing conditions*

#### *6.3.1 Viewing conditions colour contrast*

At all times during the examination with the non-fluorescent method, the light intensity at the surface to be examined shall be 1076 Lux. as a minimum.

The light intensity shall be measured if a change exist that the light intensity is below the specified value.

#### *6.3.2 Viewing conditions fluorescent*

At the use of fluorescent particles the black light intensity has to be 1000  $\mu\text{W}/\text{cm}^2$  as a minimum at the surface to be examined and shall be executed in a darkened area using filtered black light, background light may not exceed 21.5 Lux.

The black light intensity shall be measured if a change exist that the light intensity is below the specified value.

The examiner shall be present in the darkened room at least 5 minutes prior to examination and shall not wear photosensitive lenses/glasses.

### *6.4 Pre-cleaning*

Prior to the examination the surface shall be cleaned with one of the cleaners.

## *6.5 Drying*

After cleaning, drying of the surface to be examined shall be accomplished by normal drying (evaporation) or with forced hot or cold air. A minimum time of 5 minutes shall be established to ensure that the solvent has been evaporated completely prior to application of the penetrant.

## *6.6 Penetrant application*

The penetrant shall be applied, within 60 minutes after drying.

The penetrant can be applied to the part or weld examined by spraying, brushing, flooding, dipping or immersion.

## *6.7 Dwell-time*

Minimum dwell time of the penetrant is 5 minutes for castings and welds, 10 minutes for wrought materials. The maximum dwell time shall not exceed 2 hrs.

Care shall be taken to ensure that the test surface remains completely wetted throughout the entire penetration dwell-time.

## *6.8 Excess penetrant removal*

Excess penetrant at the surface shall be removed after the dwell time.

### *6.8.1 Solvent removable penetrants*

The surface shall be cleaned with a dry, clean, lint-free cloth or absorbent paper, until most traces of penetrant have been removed.

The remaining traces shall be removed by carefully wiping the surface with cloth and/or absorbent paper, moistened with cleaner.

Spraying or flushing with cleaner to remove the excess penetrant is prohibited.

### *6.8.2 Water washable penetrants*

The surface shall be cleaned with a water spray at an angle of approx. 45°, or with a dry, clean, lint-free cloth or absorbent paper, until most traces of penetrant have been removed. The water pressure shall not exceed 50 psi and the temperature shall not exceed 43°C.

The remaining traces shall be removed by carefully wiping the surface with dry lint-free cloth and/or absorbent paper, moistened with water.

## *6.9 Drying*

After the removal of excess penetrant, the surface shall be dried by normal evaporation, or by using dry lint-free cloth or dry tissue.

Drying time will not be so long that the penetrant will dry out.

## *6.10 Developing*

The developer shall be applied as soon as possible after the excess penetrant has been removed and the surface has been dried. The wet developer shall be applied with a sprayer.

Insufficient developer coating thicknesses may not draw the penetrant out of discontinuities; conversely, excessive developer coating thickness may mask indications.

Prior to applying wet developer to the surface, the developer must be thoroughly agitated to ensure adequate dispersion of suspended particles.

### *6.11 Developing time*

Developing time begins immediately after the application of a dry developer or as soon as the wet developer coating is dry.

### *6.12 Interpretation*

Final interpretation shall be made between, not less than 10 min and not more than 60 min after the requirements of 6.8 are satisfied.

The true size and type of discontinuities are difficult to evaluate if the penetrant diffuses excessively into the developer. Consequently, the surface shall be closely observed during the application of the developer to monitor the behaviour of indications which tend to bleed out excessively.

If the surface to be examined is too large to perform the complete interpretation within the prescribed time, the surface shall be examined in parts.

During the interpretation the light intensity shall be as described in section 6.3.

### *6.13 Re-examination*

In case of re-examination this procedure will be completely repeated.

**Note:**

Fluorescent penetrant examination shall not follow on a colour contrast penetrant examination.

### *6.14 Post examination cleaning*

The examined areas will be cleaned after examination with clothes and penetrant remover as far as possible. The possibility exists that not all penetrant is removed out of the material surface pores.

## **7 Evaluation of indications**

All indications shall be evaluated in term of the acceptance standard.

Discontinuities at the surface will be indicated by bleed-out of penetrant; however, localized surface irregularities due to machining marks or other surface conditions may produce false indications.

Broad areas of fluorescence or pigmentation which could mask indications of discontinuities are unacceptable and such areas shall be cleaned and re-examined. Third bullet point below.

An indication of an imperfection may be larger than the real imperfection.

However the size of the indication will be the basis for the acceptance standard.

All indications with dimensions  $\geq 1.5$  mm shall be considered relevant.

- A linear indication is an indication, having a length greater than three times the width.
- A rounded (non-linear) indication is an indication of circular or elliptical shape with a length equal to or less than three times the width.
- Any questionable or doubtful indication shall be re-examined, possible after surface improvement, to determine whether or not they are relevant.

## 8 Acceptance standard

All examined surfaces shall be free of:

- Relevant linear indications.
- Relevant rounded indications  $\geq 5.0\text{mm}$ .
- Four or more relevant rounded indications in line separated by 1.5 mm or less, measured from edge to edge.

## 9 Records

For each penetrant examination carried out a report shall be written. Each report shall contain the following information as minimum:

- Procedure number and revision.
- Examination standard, acceptance standard.
- Client.
- Date of examination.
- Penetrant used incl. batch numbers (visible or fluorescent, wet or dry).
- Object data and examined parts;
  - identification of the weld, part, or component examined including weld number, serial number, or other identifier,
  - extent of examination,
  - base material,
  - type of weld / shape, welding process and filler material,
  - heat treatment (if applicable),
  - thickness,
  - temperature of the object.
- Viewing conditions(light intensity).
- Lighting equipment.
- Drawing or record of all relevant indications exceeding the acceptance standard;
  - All relevant indications shall be reported with as minimum the type, location and extent (length, diameter or aligned).
- Name operator(s) qualification and signature operator(s) who performed examination.