

Please see comments on Document "Dokumentation_11000104289_EN"
and implement those are applicable for oil pump motor

Operating Manual

Low Voltage-Asynchronous Motor with Squirrel-Cage Rotor

Type : NDOR100L-04-3G

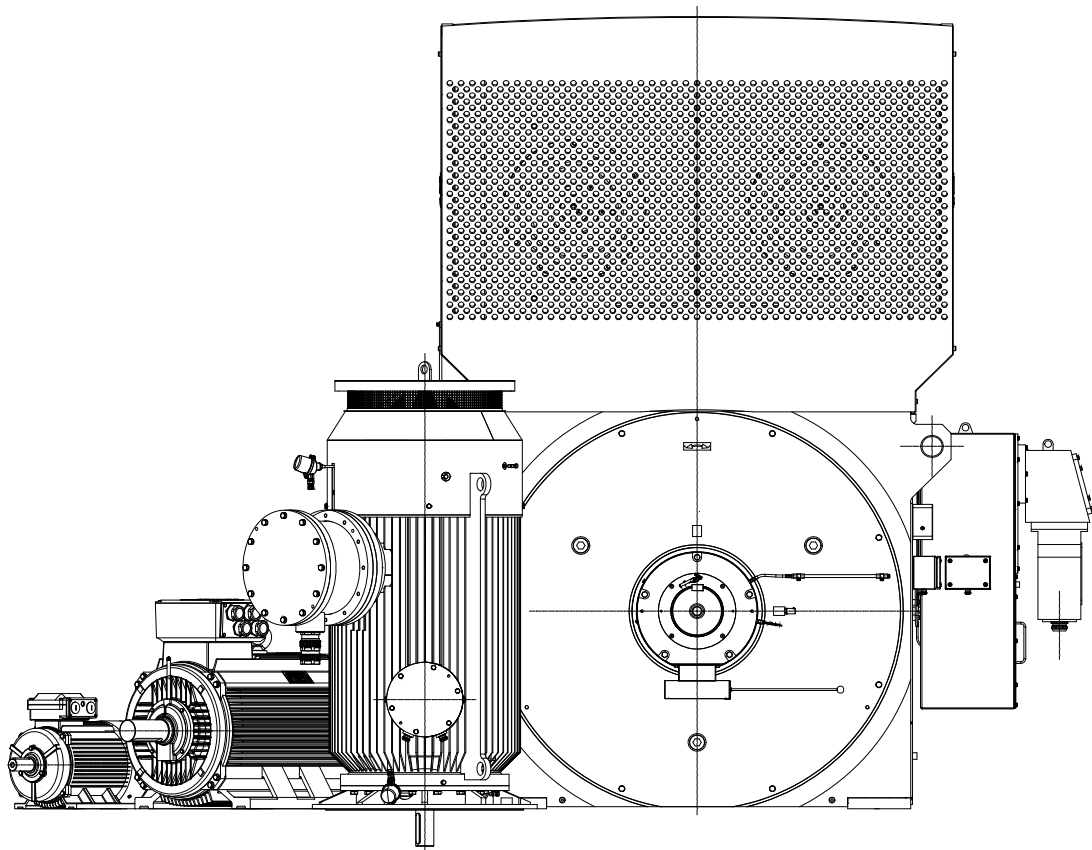

Customer.....: DELTA GmbH

Order-No.....: 11042400635

Ident.-No.....: 11000104292

Operating Instructions

Three-Phase Induction Motor

| | |
|----------|--------------------------|
| 1 | Safety Guidelines |
|----------|--------------------------|

| | |
|----------|--------------------|
| 2 | Description |
|----------|--------------------|

| | |
|----------|--|
| 3 | Transport, Storage, Installation and Assembling |
|----------|--|

| | |
|----------|-----------------|
| 4 | Start-up |
|----------|-----------------|

| | |
|----------|------------------|
| 5 | Operation |
|----------|------------------|

| | |
|----------|--------------------|
| 6 | Maintenance |
|----------|--------------------|

| | |
|----------|--|
| 7 | Additional Instructions for Ex-Motors |
|----------|--|

| | |
|----------|--------------|
| 8 | Annex |
|----------|--------------|

Table of Contents

| | | |
|----------|---|------------|
| 1 | Safety Guidelines | 1-1 |
| 1.1 | Safety and application instructions | 1-2 |
| 1.2 | Switching high-voltage motors..... | 1-4 |
| 1.3 | Electromagnetic compatibility | 1-4 |
| 2 | Description | 2-1 |
| 2.1 | Intended use | 2-1 |
| 3 | Transport, Storage, Installation and Assembling | 3-1 |
| 3.1 | Transport | 3-1 |
| 3.2 | Storage | 3-2 |
| 3.2.1 | Preparation of storage and preservation (mothballing) | 3-3 |
| 3.2.2 | Inspection and maintenance during storage for extended periods of time (long-term storage)..... | 3-3 |
| 3.3 | Installation..... | 3-5 |
| 3.4 | Aligning | 3-6 |
| 3.5 | Mounting | 3-7 |
| 3.6 | Connecting the stator winding | 3-8 |
| 3.7 | Connecting the earthing conductor | 3-11 |
| 3.8 | Connecting the auxiliary circuits..... | 3-12 |
| 3.9 | Sleeve bearings | 3-13 |
| 4 | Start-up | 4-1 |
| 4.1 | Temperature monitoring of the stator winding..... | 4-1 |
| 4.2 | Checking the insulation resistance | 4-3 |
| 4.3 | Drying | 4-5 |
| 4.4 | Start-up of sleeve bearings..... | 4-6 |
| 4.5 | Measures to be performed prior to commissioning | 4-7 |
| 4.6 | Switching high-voltage motors..... | 4-8 |
| 5 | Operation | 5-1 |
| 5.1 | Safety instructions | 5-1 |
| 5.2 | Drives with insulated bearings..... | 5-1 |
| 5.3 | Starting | 5-1 |
| 5.4 | Operation | 5-3 |
| 5.5 | Stoppages..... | 5-3 |

| | | |
|----------|--|------------|
| 6 | Maintenance | 6-1 |
| 6.1 | Preparations for maintenance | 6-1 |
| 6.2 | Cleaning the motor | 6-1 |
| 6.3 | Lubrication and maintenance instructions for roller bearings | 6-1 |
| 6.4 | Maintenance instructions for sleeve bearings | 6-4 |
| 6.5 | Maintenance instructions for freestanding drives | 6-4 |
| 6.6 | Servicing | 6-5 |
| 6.6.1 | Servicing instructions | 6-5 |
| 6.6.2 | First service after installation or repair | 6-5 |
| 6.6.3 | General inspection | 6-5 |
| 6.7 | Corrective maintenance | 6-6 |
| 6.7.1 | Preparations for overhauling / repairs | 6-6 |
| 6.7.2 | Dismantling | 6-6 |
| 6.7.3 | Re-assembly | 6-7 |
| 6.8 | Tightening torque of screw connections | 6-7 |
| 6.9 | Malfunctions | 6-9 |
| 7 | Additional Instructions for Explosion-Proof Motors | 7-1 |
| 7.1 | General | 7-1 |
| 7.2 | System-specific ignition hazards | 7-1 |
| 7.3 | Assembly and connection | 7-2 |
| 7.4 | Operation | 7-5 |
| 7.5 | Repairs | 7-6 |
| 7.6 | Bridging the bearing insulation | 7-7 |

Notes

These operating instructions do not contain all detailed information for clarity reasons and also cannot consider every conceivable application.

If you would like additional information or if special problems should occur, which are not treated in detail in the operating instructions, you may request the required information via the local HELMKE branch or the HELMKE service.

We would also like to point out that the content of these operating instructions are not a part of a former or existing agreement, commitment or a legal relationship or should revise one. All obligations by HELMKE result from the respective purchasing contract, which also contains the complete and solely valid warranty provisions. These contractual warranty provisions are not expanded or limited by the details of these operating instructions, however, apply only on the condition that our storage, installation, commissioning and operating instructions as well as the inspection and maintenance rules are respected and taken into account. The required measurements and controls of the delivery item must be documented and sent to HELMKE.

J. HELMKE & Co

Ludwig-Erhard-Ring 7–9
31157 Sarstedt / Germany



Phone: +49 (0) 50 66 903 33 – 0
Fax: +49 (0) 50 66 903 33 – 291

e-mail: helmke@helmke.de
Web: www.helmke.de

1 Safety Guidelines

This chapter

This manual contains notices you have to observe in order to ensure your personal safety, as well as to prevent damage to property. The notices referring to your personal safety are highlighted in the manual by a safety alert symbol; notices referring only to property damage have no safety alert symbol. These notices shown below are graded according to the degree of danger.

| | |
|---|---|
|  Danger | <p style="text-align: center;">Danger</p> <p>indicates that death or severe personal injury will result if proper precautions are not taken.</p> |
|  Warning | <p style="text-align: center;">Warning</p> <p>indicates that death or severe personal injury may result if proper precautions are not taken.</p> |
|  Caution | <p style="text-align: center;">Caution</p> <p>with a safety alert symbol indicates that minor personal injury can result if proper precautions are not taken.</p> |
| Caution | <p style="text-align: center;">Caution</p> <p>without a safety alert symbol indicates that property damage can result if proper precautions are not taken.</p> |
| Notice | <p style="text-align: center;">Notice</p> <p>Notice indicates that an unintended result or situation can occur if the corresponding information is not taken into account.</p> |

If more than one degree of danger is present, the warning notice representing the highest degree of danger will be used. A notice warning of injury to persons with a safety alert symbol may also include a warning relating to property damage.

Qualified personnel

The device / system may only be set up and used in conjunction with this documentation. Commissioning and operation of a device / system may only be performed by qualified personnel. Within the context of the safety notes in this documentation qualified persons are defined as persons who are authorized to commission, ground and label devices, systems and circuits in accordance with established safety practices and standards.

Prescribed usage

Note the following:

| | |
|---|---|
|  Warning | This device may only be used for the applications described in the catalogue or the technical description and only in connection with devices or components from other manufacturers which have been approved or recommended by HELMKE. Correct, reliable operation of the product requires proper transport, storage, positioning and assembly as well as careful operation and maintenance. |
|---|---|

Disclaimer of liability

We have reviewed the contents of this publication to ensure consistency with the hardware and software described. Since variance cannot be precluded entirely, we cannot guarantee full consistency. However, the information in this publication is reviewed regularly and any necessary corrections are included in subsequent editions.

1.1 Safety and application instructions

Safe use of electric motors

These electrical machines are to be classified as partly completed machinery within the meaning of the Machinery Directive/Machinery Regulation of the European Economic Area, as it cannot in itself perform a specific application and which is only intended to be incorporated into or assembled with machinery or other partly completed machinery or equipment, thereby forming machinery. This classification also applies analogously if other European or comparable national directives, ordinances or regulations apply.

This results in necessary assessments of risks that cannot be covered by the electrical machines themselves, such as:

- ▶ Danger from electrical voltage,
- ▶ Danger from rotating parts,
- ▶ Danger from hot surfaces,
- ▶ Danger due to noise emissions,
- ▶ Danger due to escape of hot gas or plasma in the event of faults, particularly in the main terminal box,
- ▶ Danger due to chemical, highly flammable or combustible substances due to chemical, highly flammable or combustible substance.

Please observe the standards as defined in the IEC/EN 60204 series for the safety of machinery and their electrical equipment, as well as EN 50110-1 for the operation of electrical systems and the national safety requirements in accordance with EN 50110-2.

Electrical systems in locations subject to explosion hazards must be assembled, installed, and operated in accordance with the applicable rules and regulations. It is

assumed that system operators can ensure that the above-mentioned rules and regulations are observed during assembly, installation, and operation, and that the appropriate tests are carried out. We recommend that these tests be carried out and documented in coordination with the authorities responsible.

Commissioning is prohibited until the conformity of the end product with these directives, ordinances or regulations has been established.

| | |
|--|--|
|  Danger | <p>Electric motors are designed for use in industrial power systems. Rotating or live and uninsulated parts can be dangerous.</p> <p>Fatal or severe injuries and substantial material damage can occur if the required covers are removed without authorization or if the equipment is not handled, operated, or maintained properly.</p> |
|--|--|

Safety precautions

Before starting any work on the motor or other equipment, particularly before opening covers over live or moving parts, the motor must be properly isolated from the power supply. Besides the main circuits, any additional or auxiliary circuits that may be present must also be isolated. The usual 5 safety rules (as set forth in EN 50110-1) are:

1. Isolate the equipment
2. Take effective measures to prevent reconnection
3. Verify equipment is dead
4. Earth and short-circuit
5. Cover or fence off adjacent live parts

The precautions listed above should remain in force until all maintenance work is finished and the motor has been fully assembled.

| | |
|--|---|
|  Danger | <p>If the motors are used outside industrial areas, the installation site must be safeguarded against unauthorized access by means of suitable protection facilities (e. g. fencing) and appropriate warning signs.</p> <p>Binding clarification of the on-site risks and of any required measures can only be provided by the system operator in agreement with the supervisory authority responsible.</p> |
|--|---|

The persons responsible for the safety of the system are obliged to ensure that:

- ▶ basic system planning as well as all transportation, assembly, installation, commissioning, maintenance, and repair activities are carried out and checked by qualified personnel,
- ▶ these instructions and the motor documentation are available at all times while work is in progress,

- ▶ the technical data and specifications regarding the permissible installation, connection, ambient, and operating conditions are considered at all times,
- ▶ the system-specific construction and safety regulations are observed and personnel protective gear is used,
- ▶ all work on these motors or in the vicinity of these motors must be carried out by qualified personnel only.

For this reason, these operating instructions only contain the information required for the motors to be used by qualified personnel in accordance with their intended purpose.

| | |
|-------------|---|
| Note | We recommend engaging the support and services of your local HELMKE service centre for all planning, installation, commissioning, and maintenance work. |
|-------------|---|

1.2 Switching high-voltage motors

Switching surges

When vacuum circuit-breakers and vacuum contactors are used, it is possible for so-called multiple reignitions to occur on disconnection, depending on various factors (such as the circuit-breaker turn-off principle, motor size, length of the incoming cable, system capacitance etc.).

As a result of these reignitions, in individual cases there may be inadmissibly high switching surges for the insulation of the motor stator winding, namely when high-voltage motors with starting currents $I_s \leq 600$ A are switched off during starting or after blocking. Depending on the ratio of starting current to nominal current, and depending on the mains voltage dip (up to approx. 20 %) during motor start-up, this current limit corresponds to an upper power output limit of approx. 750 kW at $U_n = 3$ kV, approx. 1500 kW at $U_n = 6$ kV and approx. 2500 kW at $U_n = 10$ kV.

| | |
|----------------|--|
| Caution | For high-voltage motors up to this size, the planning departments must make provision for appropriate overvoltage limiters, when vacuum circuit-breakers and vacuum contactors are used. |
|----------------|--|

A limiter to ground is installed in the switchgear between the circuit-breaker and the cable termination for each of the three conductors. The level of protection for the motor windings is sufficient given the correct choice of limiters (rated motor voltage / response voltage).

1.3 Electromagnetic compatibility

Instructions relevant to safety

When used in accordance with their intended purpose and operated in an electrical supply system with characteristics to EN 50160, the enclosed motors (IP54 and

higher) comply with the requirements of the EU Directive 2014/30/EU concerning electromagnetic compatibility.

| | |
|---------------|--|
| Notice | If the load torque is very irregular (e. g. when driving a reciprocating compressor) a non-sinusoidal motor current will be induced whose harmonics might bring about an excessive reaction on the supply system and so cause excessive emitted interference on the power supply connecting leads. |
|---------------|--|

| | |
|---------------|---|
| Notice | If operated in combination with converters, the emitted interference is varying in strength, depending on the design of converter (type, interference suppression measures, and manufacturer). In order to avoid exceeding the limit values as per IEC/EN 61000 on the drive system, consisting of motor and converter, the EMC information given by the converter manufacturer must strictly be observed. On motors with integrated sensors (e. g. PTC thermistors), interference voltages caused by the converter may occur on the sensor lead. |
|---------------|---|

The motor generally fulfils the requirements of interference immunity in conformity with IEC/EN 61000. If using motors with integrated sensors, the operator himself must ensure sufficient interference immunity by selecting a suitable sensor signal lead and a suitable evaluation unit.

2**Description**

2 Description

2.1 Intended use

These low-voltage machines are intended for industrial installations. They comply with the harmonized series of standards IEC/EN 60034. Their use in hazardous areas is prohibited unless they are expressly intended for such use. (observe additional instructions). The degrees of protection \leq IP23 are by no means intended for outdoor use. Air-cooled models are rated for ambient temperatures of $-20\text{ }^{\circ}\text{C}$ to $+40\text{ }^{\circ}\text{C}$ and altitudes of \leq 1000 m above mean sea level (MSL).

Ambient temperature for air-/water-cooled models should be not less than $+5\text{ }^{\circ}\text{C}$ (for sleeve-bearing machines, see manufacturer's documentation). By all means, take note of deviating information on rating plate. Field conditions must conform to all rating plate particulars.

The details of the version of the delivered machine as well as the approved operating conditions may be derived from the machine documentation.

Table 2-1 Compliance with standards

| Feature | Standard |
|--------------------------------------|-----------------|
| Dimensions and operating performance | IEC/EN 60034-1 |
| Degree of protection | IEC/EN 60034-5 |
| Cooling | IEC/EN 60034-6 |
| Construction type | IEC/EN 60034-7 |
| Noise emission | IEC/EN 60034-9 |
| Vibration severity levels | IEC/EN 60034-14 |

The data regarding the actual degree of protection, cooling, and the construction type should be taken from the motor documentation in the annex.

3 **Transport, Storage, Installation and Assembling**

3 Transport, Storage, Installation and Assembling

3.1 Transport

| | |
|----------------|---|
| Caution | Motors in a protection class lower or equal to IP23 may not be transported or stored outside without the proper additional protection against contamination and humidity. |
|----------------|---|

Transport

Immediately report damage established after delivery to transport company; Stop commissioning if necessary.

| | |
|----------------|--|
| Caution | The enclosed rotor blocking equipment must be solidly attached during the transport, in order to prevent transport damages. This equipment must only be removed prior to attaching the power takeoff (PTO) element. If the machine has to be transported after mounting the PTO element, other suitable measures must be applied for the axial stabilization (see figure below). |
|----------------|--|

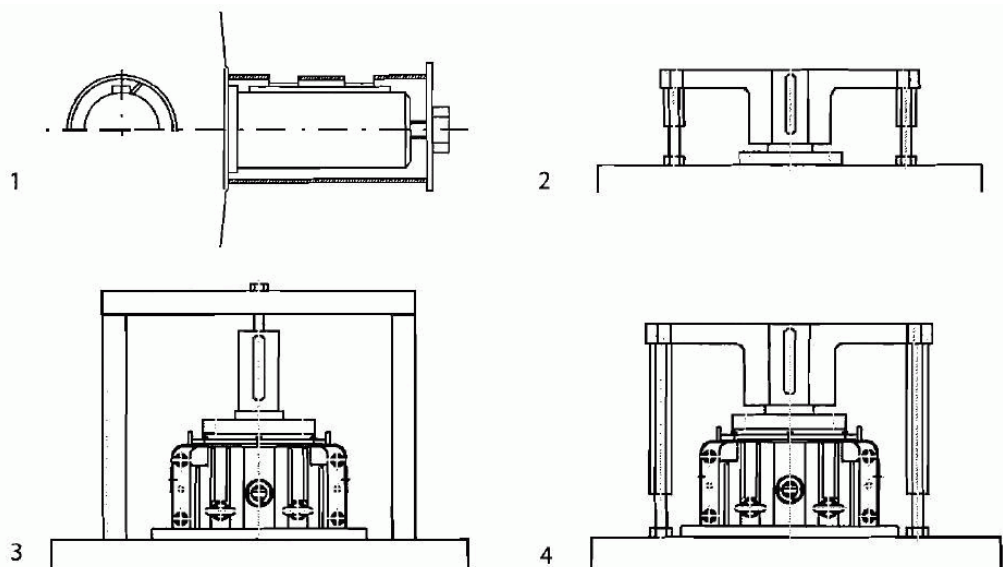

| | |
|---|--|
|  Warning | <p>Motors may only be transported and hoisted in a position corresponding to their construction type. The motors may only be hoisted using the hoisting lugs provided on the stator housing; use suitable cable guiding or spreading devices / equipment. (Motor weight refers to the rating plate or technical specifications).</p> <p>The handling instructions and markings on the motors must be observed whenever they are transported. The motor's centre of gravity is also indicated in the dimension diagram of the motor. If the centre of gravity of a load is not located centrally between the attachment points, the hoisting hook must be positioned above the centre of gravity. Pay attention to the different loads on the sling ropes or hoisting straps.</p> |
|---|--|

| | |
|---|--|
|  Warning | Only the intended openings, eyebolts and lifting pins on the base-plates may be used for transporting motor sets. Always pay attention to the carrying capacity of the lifting device. Motor sets must not be lifted by attachment to the individual motors. |
|---|--|

3.2 Storage

| | |
|---------------|---|
| Notice | The machines should be stored inside a closed room. If they are stored outside, it is more difficult to maintain the necessary conditions and the risk of corrosion and bearing damages increases. The machines and their accessories should be kept in their original packaging for transportation. |
|---------------|---|

Storage location

The storage area shall be dry, dust-, frost- and vibration-free and well ventilated. The ambient air must be free of aggressive gases and salt spray (sea air). The machines must be protected against insects and vermin such as termites and rodents as well as against the access of unauthorized persons.

Keep the relative humidity below 50 %. The ambient temperature shall be between 5 °C and 60 °C and must not be below the minimum rated temperature in general.

At higher humidity, the machine temperature should be kept approximately 10 K above the ambient temperature to avoid condensation. The temperature variation shall be less than 10 K per day. If it exceeds 10 K, turn on the anti-condensation heater, energize the machine windings or arrange other measures to increase the machine temperature relative to the ambient temperature. For that purpose a constant power supply providing the required power must be available.

If these conditions cannot be met, cover the machines with polythene foils and seal the seams for hermetical sealing. A desiccant must be used for the absorption of the water vapor inside. Humidity indicators have to monitor the air humidity inside the cover in multiple steps. Supervise the desiccant periodically and renew if necessary.

The covering has to be applied with utmost care. Ask an experienced packaging company if necessary.

Machines with sleeve bearings are generally delivered without oil. They should be stored in this condition. Machines with oil filled sleeve bearings cannot be stored for a period longer than two months unless an auxiliary device assists in turning with a speed greater than 30 rpm. Otherwise drain the oil and preserve the appropriate areas of the bearings.

Spare parts must be stored in the same manner.

Storing outdoors

Choose a storage location that is large enough, close to transportation routes and not susceptible to or protected against flooding. Repair any damage to the packaging before putting the equipment in storage. This is necessary to ensure proper storage conditions. Position machines, devices and crates flat on pallets, wooden beams or foundations that guarantee protection against soil moisture. Prevent the equipment from sinking into the ground and ensure the circulation of air underneath the equipment.

Covers or tarpaulins used to protect the equipment against rain, snow and heavy sun must not make contact with the surfaces of the stored equipment. Ensure adequate air circulation by positioning wooden spacer blocks between the equipment and such covers.

Create air ventilation and water draining holes in wooden boxes.

3.2.1 Preparation of storage and preservation (mothballing)

It is strongly recommended to log all ambient conditions and activities during preparation and storage. This especially includes all disassembling and conservation work in order for it to be checked regularly and to allow for the restoration of original conditions at the end of storage. Log all activities at the beginning and the end of as well as during the storage in order to identify faults in case of actual or later damages.

Activities at the beginning of storage:

- ▶ Check the coating and refinish if necessary.
- ▶ Protect uncoated surfaces with removable anti-corrosion coating (e. g. TEXTYL 506 or 511).
- ▶ Sleeve bearings: open the upper covers. Preserve shaft, bearing shells and all bare surfaces with removable anti-corrosion coating or with a corrosion protection which dissolves itself in the lubricating oil filled for operation. Seal all terminals and gaps.
- ▶ Mount the rotor blocking equipment. If the original rotor locking device with which the machine was supplied is no longer available or can no longer be used due to the installation of transmission elements (couplings, pulleys, etc.), other measures are required to lock the rotor.
- ▶ Open the water draining openings. Attention must be paid to a possibly changed IP protection class.
- ▶ Turn on the anti-condensation heater, energize the machine windings or arrange other measures to increase the machine temperature relative to the ambient temperature.

3.2.2 Inspection and maintenance during storage for extended periods of time (long-term storage)**Monthly**

- ▶ Measure the vibrations at the storage location.

- ▶ Check the ambient humidity respectively the humidity inside the hermetically sealed cover. Change the desiccant if necessary.
- ▶ Check the ambient temperature.
- ▶ Check the anti-condensation heater input current.

Every two months

- ▶ Check cleanness if not hermetically sealed.
- ▶ Check for potential insect infestations and damages by vermin.
- ▶ Check the isolation resistance.
- ▶ Anti-friction bearings: Turn the shaft by 10 revolutions. Remove rotor blocking equipment and remount after done work. Rotation can be omitted if there is time enough during commissioning to check the bearing (vibration measurement when the machine is rotating) and to replace them, if necessary.
- ▶ Oil filled sleeve bearings: Turn at a minimum speed of 30 rpm for 10 minutes. Remove rotor blocking equipment and remount after done work.

Every six months

- ▶ Check the hermetical seal.
- ▶ Check the coating.
- ▶ Check the protection on uncoated surfaces.
- ▶ Antifriction bearings: Regrease.
- ▶ Sleeve bearings without oil filling: Open the upper covers and check the corrosion protection. Remove rotor blocking equipment and remount after done work.

Every two years

- ▶ Clean the terminal box if not hermetically sealed.
- ▶ Sleeve bearings: Disassemble completely and check all parts. Renew anti-corrosion protection. Remove rotor blocking equipment and remount after done work.

Activities at the end of storage – recommissioning

The operating instructions, data sheets as well as the general safety instructions and the applicable standards must be observed in all points.

- ▶ Clean the machine.
- ▶ Clean terminal box.
- ▶ Remove anti-corrosion coating and restore disassembling.
- ▶ Anti-friction bearings: regrease. After more than two years, use twice the quantity of grease specified on the lubrication plate / in the data sheet and, if necessary, replace the bearings after storage of more than three years or after 18 months in the case of poor storage conditions. When motors are not stored vibration-free, the bearings must always be replaced.
- ▶ Isolated anti-friction bearings: Change bearings after two years of storage.

- ▶ Sleeve bearings: Remove anti-corrosion coating. Check bearing shells. Change if the bearing shells have imprints. Change or fill oil.
- ▶ Check the isolation resistance.
- ▶ Check the polarization index and / or the partial discharge.

3.3 Installation

- ▶ Make sure of even support, solid foot or flange mounting and exact alignment in case of direct coupling.
- ▶ Avoid resonances with rotational frequency and double mains frequency as a result of assembly.
- ▶ Avoid excessive radial and axial bearing loads (note documentation).
- ▶ Make necessary ventilating pipe connections. Models with shaft ends pointing upward have to be provided with cover by customer. The ventilation must not be obstructed and the exhaust air, also of neighboring sets, not taken in directly.

Cooling

The cooling air must be able to be drawn in and discharged unimpeded; ensure that warm discharged air is not drawn back in at the air intake. The minimum distance to the wall shall be 25 % of the air inlet respectively the air outlet diameter. On the vertical motor design with air intake from above, the air inlets must be protected against the ingress of foreign bodies and water.

Balancing quality

The rotors are balanced dynamically. For shaft ends with featherkeys, the balancing type is specified using the following coding on the face of the drive end of the shaft:

- ▶ Code 'H' means: balancing with half a featherkey (standard version); this means that in order to maintain the balancing quality, it may be necessary to cut back the part of the featherkey protruding from the drive element and the shaft profile if the motor has a short output element.
- ▶ Code 'F' means: balancing with a whole featherkey (this is a special version which must be ordered separately).

Please make sure that the power output element is correctly balanced. Power output elements may only be fitted or removed using suitable equipment.



Warning

The featherkeys are only secured during transport to prevent them from falling out. If the motor has two shaft ends, and a power output element is only fitted to one end, steps must be taken to secure the featherkey at the other end. If the rotor has the standard type of balance 'H', the featherkey must be cut back to roughly half of its normal length.

Noise emission

When assessing the noise that is emitted at a workplace (if any), it should be taken into account that the A-weighted sound pressure level, measured in accordance with ISO 1680, namely 70 dB(A), is exceeded if the three-phase AC motors are operated with the rated output.

Water drain holes

If the motor is equipped with water drain holes, then they are situated in the foot area of the bearing end shields on the drive end and non drive end side and opposite the regreasing devices. They are sealed with plastic plugs. If there is a risk of condensation forming in the motor (e. g. due to severe fluctuations in ambient temperature or direct sunlight, even with high air humidity and intermittent operation or load fluctuations), it may be useful to remove the plugs located at the bottom (depending on installation position).

Vertical machines

At vertical mounted motors with shaft end up- or downwards (e. g. IM V1, IM V2, IM V5 or IM V6) assure that neither water nor other liquids can ingress into the upper bearing. Even with degree of protection IPX5 or IPX6, there is no durable sealing against permanent occurring liquids. For this purpose, protective roofs or customized, possibly rotating covers have to be installed by the user, which belong to the conditions on site.

3.4 Aligning

Instructions relevant to safety

Detailed specialist knowledge of the necessary measures is required in order to correctly align and securely mount the equipment, e. g. for:

- ▶ preparing the foundation,
- ▶ selecting and mounting the coupling,
- ▶ measuring the concentricity and axial eccentricity tolerances,
- ▶ positioning.

If personnel are not familiar with the necessary measures and procedures, we recommend using the services of the local HELMKE service centre.

Vertical and horizontal position

The shafts in clutch operation must be aligned axially and radially against each other. Gauges must be mounted securely, whereby measurements must be performed on four points, which are offset by 90° each, by simultaneously turning both clutch halves.

The adjacent image shows the axial measurement (angular misalignment). Adjust differences with metal supports. The remaining accuracy may not be greater than 30 µm in reference to a measured diameter of 200 mm.

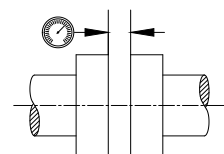

The adjacent image shows the radial measurement (eccentricity). Compensate differences by shifting or padding the relevant plates so that a residual inaccuracy of 30 µm is not exceeded.

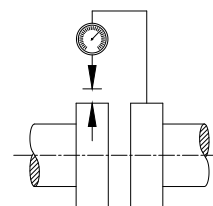

The option of an electronic measurement and alignment is offered as a modern and especially precise alternative to the above listed method. Precisely processed steel clutches can also be aligned with sufficient precision with tram gauges and feeler gauges.

Belt drives require verification that the two matching disks are flush, i. e. both shafts must be located parallel to each other and the connecting line between the disk centers must form a right angle with the shafts. It is also important that the belt tension is completed according to the guidelines of the belt manufacturers. Unnecessary high initial tension designates a risk for the shafts and bearings.

Alignment accuracy

A diameter of 0.05 mm is required to satisfy the coaxial requirements for the shafts of the motor and the driven machine.

3.5 Mounting

In order to ensure smooth, vibration-free motor operation, a stable foundation design in accordance with DIN 4024 is required, the motor must be precisely aligned, and the components, which are to be mounted on the shaft end, must be correctly balanced. In addition, vibration speeds must meet the requirements of DIN ISO 10816-3. For new motors applies IEC/EN 60034-14.

| | |
|---------------|---|
| Notice | The area of placement must be flat with a maximum deviation of 0.1 mm. High accuracy can be achieved by placing thin shims. |
| Notice | <p>The horizontal and vertical natural frequencies of the foundation including machine must be different from</p> <ul style="list-style-type: none"> ▶ ±10 % of the rotational frequency of the machine ▶ ±5 % at twice of the rotational frequency of the machine ▶ ±5 % of the single and double mains frequency |
| Notice | The maximum vibration speeds occurring in horizontal and vertical direction on the machine foundation near the motor feet shall not exceed 25 % of the maximum vibration speeds measured on the bearing housings of the machine in the same direction, Otherwise, it is assumed that the foundation is too elastic and the vibrations of the machine are increased. |

| | |
|---------------|---|
| Note | Where a belt drive is used, it is of advantage to use sliding rails to mount the motor so as to be able to set the correct belt tension. |
| Notice | The bearings and shaft can be damaged if the belt tension is too high. It is essential, therefore, that you adhere to the permissible values. |

Motors that are attached by their mounting feet to the wall because of their design must be supported from below by a wall strip, for example, or pinned.

Use machine fixing bolts with the necessary strength class to ISO 898-1 (e. g. 10.9) for reliable mounting and safe transmission of forces results from torque. When selecting the bolts and the design of the foundation you must take into account the maximum forces occurring in the case of a fault (e. g. short circuit or system transfers in phase opposition). The values for the foundation forces can be found in the configuring documentation or are available on request from the manufacturer.

Clutches or other drive side elements may only be pulled, i. e. removed (heating!) with suitable tools and covered with an accidental-contact protection.

Only clutches with a perfect, i. e. even driver pitch may be used. The identical elasticity factor and quality condition must be verified for a complete set of elastic transfer elements. Any non-uniformity causes flexural vibrations in the shaft area due to cranking forces, especially at high torque, resulting in a risk of serious motor damages due to grinding the rotor in the stator core. The manufacturer's instructions regarding the assembly and alignment must be observed specifically for special clutches. Pulleys, etc. must be balanced dynamically and possibly at the operating speed.

Motors with reinforced bearings (cylindrical roller bearing on drive side) may incur problems of a different type under certain circumstances: if fast (2- / 4-pole) motors of a small to medium size are coupled via a shackle (e. g. ELCO) and very well centered, the cylindrical roller bearing on the drive side is radially barely stressed. This may then result in running problems, which result in the rolling elements slipping on the wearing surfaces. An unexpected increase of the bearing temperature is the result.

The entire drive concept with consideration to the thermal longitudinal expansion of the shafts as well as the radial/axial loads, etc. is essential for the bearing decision.

3.6 Connecting the stator winding

Compare the grid type and desired operating data with the motor rating plate – note the connection type. If not otherwise specified, the performance data (with tolerances according to IEC/EN 60034) relate to a max. 40 °C ambient temperature at a maximum set-up height of 1,000 m above MSL, possibly under the conditions of the specified coolant or external air data.

The connection must be performed according to local installation regulations by using the proper cables. Terminals for earthing the housing may be found in the terminal box

or below at the motor pedestal. The connection diagram, which may be found in the terminal box, must be observed. Special care is required for voltage or pole changing motors – we request that you contact us prior to start-up in the event of uncertainty.

The motor shaft will turn toward the right when viewed from outside against the shaft journal at an equidirectional connection of power phases L1, L2, L3 to motor connection U1, V1, W1 – therefore clockwise. If a counter-clockwise rotation is desired, two phases must be exchanged.

| | |
|---------------|--|
| Notice | <p>The rating plate of motors, which are only suitable for one direction of rotation due to rotation direction dependent fans, contains a suitable marking. A direction of rotation arrow is also attached to the motor housing above the journal or on the fan cover. A contrariwise rotation is not permitted, since the motor is then overheated due to a lack of cooling air. A change in the direction of rotation can only be achieved with new or modified fans. In such a case the rebalancing of the rotor may also become necessary!</p> |
|---------------|--|

All terminals must be firmly tightened, since extreme heating and therefore a destruction of the insulation may be anticipated.

The connections of any temperature monitoring systems (such as PTC thermistors, Pt100-measurement resistors) for the winding and bearings as well as an anti-condensation heater, etc. are generally located in an additional terminal box including the connection diagram and technical data. The use of this system is necessary in the interest of operating safety. In order to prevent potentially serious damages due to an incorrect connection, we are requesting that you contact us, if you need information of the necessary analysis systems, etc.

A switching device with a short-circuit release and a thermal overcurrent tripping devices adjusted to the rated winding current must be used to realize an upstream motor protection.

| | |
|---------------|--|
| Notice | <p>The thermal tripping devices of squirrel-cage induction motors with star-delta starting must detect the phase winding current in the delta connections between the motor and the breaker (contactor) and must therefore be set at the lower star current ($= 0.577 \cdot \text{rated motor current}$).</p> |
|---------------|--|

Connection with cable lugs

Remove the insulation from the conductor ends so that the remaining insulation is almost long enough to reach the cable lug. If necessary, insulate the cable lugs in order to maintain the minimum air clearances. The air clearance for maximum operation voltages up to 6.3 kV +10 % must be at least 60 mm; the minimum air clearance for maximum operation voltages up to 10 kV +10 % is 100 mm.

| | |
|---------------|--|
| Notice | The current-carrying capacity of the connection is ensured by the CuZn contact nuts. These nuts must not be replaced by parts made from other materials. |
|---------------|--|

Connection without cable lugs

Clamp-type terminals can be ordered, which are suitable for connecting flexible conductors without wire end ferrules.

Wire end ferrules should only be used if they are attached to the conductor before connection, using an appropriate, current-carrying crimp connection.

To ensure safe clamping and enclosure of the conductor end, only one conductor can be connected.

| | |
|---------------|---|
| Notice | If aluminum conductors are connected, we recommend removing the oxide film using a brush or file prior to inserting them in the clamps. The conductors should then be immediately greased using neutral Vaseline in order to prevent re-oxidation. Yielding of the aluminum is also likely after the conductors have been connected due to the contact pressure. This should be compensated by tightening the clamping nuts after approximately 24 hours and again after about 4 weeks. |
|---------------|---|

Cable entry and routing

The connecting cable is sealed at the cable entry location and is fastened using a strain relief device. The strain relief device can be located either in the terminal box or externally.

We recommend the following procedure while using cut-out seal insert:

- ▶ Cut out the seal insert so that its opening is 1 to 3 mm smaller than the cable diameter. If the cable diameter is too small, increase it by wrapping a layer of suitable sealing tape around the conductor.
- ▶ After inserting the seal, make a termination to match the cable and connect an earthing cable to it. If the cable has external armoring, do not route it directly into the terminal box, but just up to the strain relief device, which in this case should also be fitted externally. This prevents moisture from penetrating into the terminal box.
- ▶ Unscrew the upper section of the strain relief device and release the mounting screws for the lower section. Insert the cable with seal insert into the gland opening. When the cable is positioned concentrically inside the gland opening, screw the strain relief clip together and secure it.

| | |
|---------------|---|
| Notice | Tighten the clamping screws of the strain relief clip as much as necessary to produce the required effect but not so much as to damage the insulation. The recommended tightening torque is 5 Nm. Retighten the clamping screws after 24 hours. |
|---------------|---|

Internal equipotential bonding

The equipotential bonding between the ground terminal in the terminal box housing and the motor frame is established via the terminal box mounting bolts. The contact points underneath the bolt heads are bare metal and are protected against corrosion.

The standard terminal box cover mounting screws are adequate as potential bonding between the terminal box cover and terminal box itself.

Final checks

Please check that:

- ▶ the electrical connections in the terminal box are tight and are in full compliance with the specifications above,
- ▶ the machine is connected in accordance with the specified direction of rotation,
- ▶ the inside of the terminal box must be clean and free of any pieces of cable,
- ▶ all gaskets and seals are undamaged and properly secured,
- ▶ the pressure relief device (depending on the type of terminal box: either cast-in slots or an overpressure diaphragm). Any damage may only be repaired after prior discussion with the person responsible for the safety of the installation and only by using original-parts.

Then close the terminal box.

3.7 Connecting the earthing conductor

The cross-section of the earthing conductor must correspond with the set-up regulations, i. e. according to IEC/EN 60204-1, with at least 50 % of the line conductor cross-section for cross-sections of $> 35 \text{ mm}^2$ of the live conductor.

If operated in combination with converters, the equipotential bonding has to be made with a flat conductor of 70 mm minimum width.

A hex bolt with a spring-lock washer and a plain washer is located on the stator frame at the marked connecting point for the earthing conductor, suitable for connecting multi-wire conductors with cable terminals or flat belts with a suitably designed conductor end.

When connecting, please note that:

- ▶ the connecting face is a bare contact and protected against corrosion with suitable material, such as acid-free petrolatum,
- ▶ the spring-lock washer and plain washer are arranged below the screw head,
- ▶ the minimum required thread engagement and the tightening torque for the setscrew are adhered to.

3.8 Connecting the auxiliary circuits

The model descriptions of the attached additional terminal boxes are defined in the motor documentation, including the arrangement of the additional terminal boxes and the respective terminals.

The necessary details for connecting the auxiliary circuits may be derived from the terminal diagram in the interior of the respective lid and from the machine documentation.

Select the connecting cables with consideration to the rated current and the conditions related to the facility (such as the ambient temperature, routing method, etc. according to IEC/EN 60204-1).

At frequency converter operation depending on converter design (type, electromagnetic interference suppression, make) inverter generated noise voltages can occur in different intensities especially at the sensor connection wires. These are highly dependent on the conditions at the place of use (e. g. grounding of machine and converter, shielding of cables, connection of the cable shields to ground and position of the connecting cables in relation to the power cables) and cannot be influenced by the motor itself. Corrective measures must be carried out by the operator.

Internal equipotential bonding

The equipotential bonding between the protective conductor terminals in the terminal box and the motor frame is established through a mounting bolt in the terminal box; the contact location under this bolt head is bare metal and is protected against corrosion.

Final checks

Before closing any of the terminal boxes, please check that:

- ▶ the cables are connected in accordance with the terminal diagram inside the terminal box cover,
- ▶ the inside of the terminal box must be clean and free of any pieces of cable,
- ▶ the cable glands are firmly tightened, and are suitable regarding the degree of protection, type of cable routing, permissible cable diameter etc, and have been mounted in full compliance with the specifications and regulations,
- ▶ the connecting cables are laid without touching the machine, and the cable insulation cannot be damaged,
- ▶ any cable entries which are not used are sealed and the plugs are tightly screwed in (i. e. so that they can only be removed using the suitable tools),
- ▶ all of the seals / gaskets and sealing surfaces of the terminal box are in a good condition,
- ▶ for screw terminals, ensure that all of the terminal screws have been firmly tightened (this also applies to any terminals which are not in use).

3.9 Sleeve bearings

Sleeve bearings are subdivided into bearings with oil lubrication rings and natural or water cooling, bearings with circulating oil lubrication and bearings with hydrostatic jacking.

| | |
|-------------|--|
| Note | With standard bearings, there is no axial guide. It cannot and must not carry axial forces. The axial position is determined by the magnetic center of the stator and rotor of the motor. The axial clearance is specified in the drawing of the motor. On the motor there is a pointer that indicates the magnetic center to allow for axial alignment at a standstill. |
|-------------|--|

The housing of the bearing consists of two parts and it can be opened. The inner bearing shells are spherical and allow self-alignment functionality on the mechanical load and the operational and thermal changes of the motor. Oil lubrication rings may also be present in bearings with circulating oil lubrication for a damage-free shutdown.

Sleeve bearings with natural cooling

Sleeve bearings with natural cooling release their thermal losses over the surface. During the design of the system, it is important to consider that the maximum permissible ambient temperature of the bearing housing is not exceeded. If necessary, the area of the bearing is to be ventilated separately.

Sleeve bearings with water cooling

Water-cooled bearings can be integrated into the general circulation of the motor cooling water. The water speed shall not exceed 1.5 m/sec. If necessary, reduction valves must be used. The water shall work without back-pressure. Observe the instructions in the manual for water-cooled motors and the values indicated on the instruction plate on the motor.

Sleeve bearings with circulating oil lubrication

The oil speed shall not exceed 1.5 m/s for the inlet and 0.15 m/s for the recirculation. The pipes should have equal length. The recirculation pipe should have a slope of at least 15 degrees in order to avoid oil backflow. Otherwise, larger cross-sections must be used.

All components of the oil supply must be clean and oil-resistant. If there is no oil lubrication ring as a reserve in the bearing, a redundant pump is necessary. The inlet side must be fitted with a filter with a rating of 15 to 25 microns and oil pressure reducing valves for an adjustable oil pressure of 0.02 to 0.08 MPa to adjust the oil volume rate of each bearing.

For observation temperature sensors, pressure switches and flow monitors shall be installed if necessary.

The oil temperature in the inlet must not fall below -10 °C.

| | |
|---------------|---|
| Notice | If the lubricating oil is supplied by the lubrication system of a gear unit, then the compatibility of the bearing metal with the lubricant must be tested. |
|---------------|---|

4 Start-up

4.1 Temperature monitoring of the stator winding

- a) PTC thermistors are electronic components with a stamped characteristic bend at a defined temperature. Several hundreds of ohms can be measured below these on the respective terminals (2 terminals per set) and several kilohms above these by using a simple ohmmeter.

| | |
|---------------|--|
| Notice | The measurement current may only equal a few milliamps! Never connect any external voltage (such as 230 V power supply), since the result would be an immediate destruction of the sensitive components and due to arc development, possibly also an irreplaceable winding damage. |
|---------------|--|

Two PTC thermistor sets are frequently included in the windings for larger motors for various temperatures for the advance warning and cut-off. A triggering device must be connected to each set for evaluation, the potential-free relay contacts must be used for the respective motor control circuits. Subsequently changing the temperature values are not possible – only by installing additional PTC thermistor sets on the winding overhang.

- b) Klixons or micro-term switches are thermal switches, which are firmly set, similar a) installed and directly usable for the control circuits by auxiliary contactors. Inspection: No resistance on the respective terminals in the cold state; a passage therefore exists which is interrupted after falling below the defined switching temperature.

| | |
|---------------|--|
| Notice | Such contacts may not switch a greater inductive load – connect auxiliary coils with an R-C snubber element! |
|---------------|--|

- c) Directly displaying thermometers with adjustable threshold value contacts are practically only used for monitoring the bearing temperature. In reference to the contact loading, the protecting method listed under b) applies. For adjusting advices: see final paragraph.
- d) Thermal elements (such as Ni/CrNi) produce a temperature-related thermoelectric voltage according to a specific characteristic curve, which must be analyzed in separate transducers for the temperature display, possibly with threshold value contacts according to c). These temperature sensor are very low-resistance ($m\Omega$) and deliver voltages in the millivolt range. They are used within slide bearings shells, seldom in the winding area.
- e) Resistance thermometers are calibrated temperature measurement resistors (generally with a platinum wire → Pt100 with $100\ \Omega$ at $0\ ^\circ\text{C}$ and $0.385\ \Omega$ resistance change per Kelvin; they have a linear progression: i.e. $138.5\ \Omega$ at $100\ ^\circ\text{C}$ or $153.9\ \Omega$ at $140\ ^\circ\text{C}$). Each thermometer is applied to two (possibly three / four) terminals, possibly combined with overvoltage protection und fuses in an additional terminal box. The

terminals are frequently combined to a joint conductor. As described under a), the resistance determination can be used to check the resistances and the temperature can be calculated by this method according to the appropriate conversion. A suitable measuring amplifier with a signal relay for a separate adjustment of advance warning and cut-off temperature must be used for each resistor (i.e. for Pt100) (these are available for five or eight measuring circuits in one housing – for example, for 3 or 6 units per winding and 2 units per bearing).

| | |
|---|---|
|  Warning | <p>The insulation of the temperature sensors for winding monitoring is designed relative to the winding in accordance with the requirements for basic insulation. The temperature sensor leads are safe to touch in the terminal box and have no protective separation.</p> <p>In the event of a fault, dangerous voltage may be present on the sensor cable.</p> <p>When connecting the temperature sensors to an external temperature monitoring system, where necessary take additional measures to comply with the requirements of IEC/EN 60664-1 resp. IEC/EN 61800-5-1.</p> |
|---|---|

Determination of the switching values:

1. Maximum cut-off temperatures for the initial setting for the start-up:

Table 4-1 Maximum cut-off temperatures for initial setting

| Windings | Warning | Cut-off |
|--|----------------|----------------|
| Isolation class 155 (F) | 140 °C | 150 °C |
| Isolation class 180 (H) | 160 °C | 170 °C |
| Bearings | Warning | Cut-off |
| Roller bearings | 100 °C | 110 °C |
| Sleeve bearings • Sensor in the bearing shell | 85 °C | 95 °C |
| Sleeve bearings • Sensor in the oil pan | 65 °C | 75 °C |

Any exceeding of these values must be reported to us immediately, in order to discover the cause in time. Higher settings may be permitted in individual cases.

2. The final switching values must be set in reference to really measured operating temperatures after completing the start-up and running-in period of the machine:

Table 4-2 Maximum cut-off temperatures in reference to really measured operating temperatures

| Windings | Warning | Cut-off |
|--|--|--|
| Isolation class 155 (F) | $T + 10 \text{ K} \leq 140 \text{ }^\circ\text{C}$ | $T + 15 \text{ K} \leq 150 \text{ }^\circ\text{C}$ |
| Isolation class 180 (H) | $T + 10 \text{ K} \leq 160 \text{ }^\circ\text{C}$ | $T + 15 \text{ K} \leq 170 \text{ }^\circ\text{C}$ |
| Bearings | Warning | Cut-off |
| Wälzlager | $T + 5 \text{ K} \leq 100 \text{ }^\circ\text{C}$ | $T + 10 \text{ K} \leq 110 \text{ }^\circ\text{C}$ |
| Sleeve bearings • Sensor in the bearing shell | $T + 5 \text{ K} \leq 85 \text{ }^\circ\text{C}$ | $T + 10 \text{ K} \leq 95 \text{ }^\circ\text{C}$ |
| Sleeve bearings • Sensor in the oil pan | $T + 5 \text{ K} \leq 65 \text{ }^\circ\text{C}$ | $T + 10 \text{ K} \leq 75 \text{ }^\circ\text{C}$ |

T = Maximum of measured continuous operation temperature under actual operating conditions, above the operating temperature with consideration to the anticipated maximum ambient air and coolant temperature.

Deviating values may be logical depending on the requirement – if necessary, we will await your consultation.

| | |
|-------------|--|
| Note | Temperature sensors for monitoring the winding temperatures are located directly in or on the coil and are embedded or glued on in general. Replacement for defective sensors or retrofitting is possible only by gluing on and does not affect the functionality. Possibly temperature deviations from an embedded sensor must be considered. |
|-------------|--|

4.2 Checking the insulation resistance

| | |
|--|--|
|  Danger | <p>During the measurement, and immediately afterwards, some of the terminals are at hazardous voltage levels and must not be touched.</p> <p>If the cables are connected, ensure that the mains voltage cannot be connected. Once you have measured the insulation resistance, discharge the winding by connecting the ground potential.</p> |
|--|--|

| | |
|----------------|--|
| Caution | <p>The insulation resistance needs to be checked prior to start-up and again after any extended periods of storage or periods during which the equipment is not in operation.</p> <p>Before you begin measuring the insulation resistance, please read the manual for the insulation resistance meter you are going to use. Any cables of the main circuit which are already connected should be disconnected from the terminals in order to carry out the insulation measurements.</p> <p>Preferably measure the insulation resistance of the winding to the motor enclosure when the winding temperature is between 20 and 30 °C: Different insulation resistance values apply at other temperatures. When making the measurement, you must wait until the final resistance value is reached (approx. 1 minute).</p> |
|----------------|--|

Limit values

The following table indicates the measuring circuit voltage and the limit values for the minimum insulation resistance.

Table 4-3 Isolation resistance at 25 °C

| | measuring dc voltage | Insulation resistance |
|---|-------------------------------|-------------------------------------|
| Extra low-voltage circuits with protective-separation (e. g. temperature sensors) | 250 V | ≥ 0,5 MΩ (IEC/HD 60364-6) |
| General equipment up to 1 kV (e. g. heater) | 500 V | ≥ 1 MΩ (IEC/EN 60204-1) |
| Windings up to 1 kV | 500 V | ≥ 5 MΩ (IEC/EN 60034-27-4) |
| Windings above 1 kV up to 2,5 kV | 500 V (max. 1000 V) | ≥ 100 MΩ (IEC/EN 60034-27-4) |
| Windings above 2,5 kV up to 5 kV | 1000 V (max. 2500 V) | |
| Windings above 5 kV up to 12 kV | 2500 V (max. 5000 V) | |
| Windings above 12 kV | 5000 V (max. 10 000 V) | |
| Slip ring systems up to 1 kV | 500 V | ≥ 50 kΩ (IEC/EN 60204-1) |
| S Slip ring systems above 1 kV | Rated voltage maximum 5 kV | By arrangement (IEC/EN 60204-11) |

Note the following items:

- ▶ DC voltage shall be used to measure the insulation resistance. The voltage level must be limited to the rated voltage for which the winding is designed and adapted to the condition of the winding. This is especially important for machines in the low voltage range and for moistured windings. Too high voltages can overload the insulation and lead to an insulation fault.
- ▶ The measurement is usually performed with negative polarity to counteract the phenomenon of electroosmosis in the presence of moisture.
- ▶ No correction is required if the insulation resistance of the winding is 1 min after application of the measuring voltage $> 5 \text{ G}\Omega$ or if the temperature is below $40 \text{ }^\circ\text{C}$. Otherwise, the measured value (T in $^\circ\text{C}$) must be converted to the reference temperature of $25 \text{ }^\circ\text{C}$ in order to be able to compare the values with the table above. The insulation resistance is reduced by a factor of a half for every 10 K increase in temperature, and it is increased by a factor of two for every 10 K decrease in temperature:

$$\text{Minimum isolation resistance} \leq \text{Measured isolation resistance} \cdot 0,5^{\frac{40 \text{ }^\circ\text{C} - T}{10 \text{ K}}}$$

- ▶ New, dry windings have an insulation resistance between 100 and 2000 $\text{M}\Omega$, or even higher values. If the insulation resistance is close to the minimum value, then the cause could be humidity and / or dirt accumulation.
- ▶

| | |
|---------------|--|
| Notice | If the critical insulation resistance is less than or equal to this value, the windings must be dried or, if the fan is removed, cleaned thoroughly and dried. Please note that the insulation resistance of dried, clean windings is lower than that of warm windings. The insulation resistance can only be properly assessed after conversion to the reference temperature of $25 \text{ }^\circ\text{C}$. |
|---------------|--|

| | |
|---------------|---|
| Notice | If the measured value is close to the critical value, the insulation resistance should be subsequently checked at appropriately frequent intervals. |
|---------------|---|

4.3 Drying

Drying can be accomplished by heating the coils via direct current. However, the current should not be higher than half the rated coil current and the temperature of the coils must be monitored continuously for the respective insulation class (possibly by measuring the Cu resistance increase – therefore measure the cold coil resistance prior to starting the drying process and check it later from time to time).

The standard value for a favourable drying temperature: 1.4 times the resistance increase, if the original temperature was at approx. $20 \text{ }^\circ\text{C}$. Change the winding phases frequently! An alternate current can be supplied according to the reduced voltage (approx. 5...6 % of the rated machine voltage) with a fully stopped rotor for drying squirrel-cage induction motors.

Closed types must be opened by removing any coolers or at least in the area of access covers, air gap measurement openings, terminal plates or dummy covers to provide an air exchange – possibly blow through dry air.

In addition, in frequent cases of pure surface moisture alone flowing dry, if necessary heated air (fan heater) can bring the desired effect.

Special attention must be paid for machines with thermal coil protection (PTC thermistors) that the drying temperature remains below 120 °C (this value can be up to 180 °C in motors with insulation class 'H'). PTC thermistors may only be checked with a measuring voltage below 0.8 V.

Slot thermometer Pt100 (100 Ω at 0 °C) provide precise windings temperature measurements in conjunction with calibrated measuring amplifiers and indicating instruments. A check is also possible via a resistance bridge or an ohmmeter with a low measuring current: Resistance change is 0.385 Ω/K; i. e. measured value equal 138.5 Ω matches to a coil temperature of 100 °C.

4.4 Start-up of sleeve bearings

| | |
|----------------|--|
| Caution | When working on bearings it is important to ensure absolute cleanliness. The oil lubrication rings and seals are to be handled carefully. Damage and deformation are to avoid. |
|----------------|--|

| | |
|----------------|--|
| Caution | The running surfaces of the bearing shells are finished and must not be scraped. |
|----------------|--|

The bearings are generally delivered without oil. Before start-up they have to be filled up with oil up to the oil level mark or until the oil returns. Generally, any brand with the given viscosity indicated on the instruction plate on the motor, low foaming and good oxidation resistance can be used as a lubricant. The pour point of the lubricating oil must be at least 10 K below the minimum permissible ambient temperature of the motor.

Before starting motors with bearings with circulating oil lubrication all components have to be washed out and the filter cleaned.

| | |
|----------------|--|
| Caution | The bearings and measuring devices must not be located inside the rinsing circuit while the external oil supply is rinsed. |
|----------------|--|

For bearings with oil lubrication rings, check that the oil lubrication rings and oil scrappers have been incorporated.

Bearings with hydrostatic oil supply: Switch on and check the flow of oil.

The oil flow rate of the oil lubrication system is set according to the instruction plate on the motor.

After starting the motor, the following values shall be monitored within the first few hours:

- ▶ bearing temperatures,
- ▶ oil tightness,
- ▶ vibrations,
- ▶ run of the oil lubrication ring.

The oil temperature should not exceed 65 °C while the temperature of the bearing shell at the built-in temperature sensor shall not be over 85 °C.

4.5 Measures to be performed prior to commissioning

After assembling the motor in line with technical requirements and before starting up the system, check that:

- ▶ the machine has been properly assembled and aligned,
- ▶ the machine has been connected up in accordance with the specified direction of rotation,
- ▶ the operating conditions comply with the data specified on the rating plate,
- ▶ the bearings have been regreased (depending on model). Rolling-contact bearing motors which have been in storage for more than 2 years must be regreased,
- ▶ any supplementary motor monitoring devices and equipment have been correctly connected and are functioning,
- ▶ if bearing thermometers are fitted, the bearing temperatures are checked during the initial run of the motor and the warning and cut-off values are set on the monitoring device,
- ▶ appropriately configured control and speed monitoring functions ensure that the motor cannot exceed the permissible speeds specified on the rating plate,
- ▶ the drive side elements have the correct parameters for their type (e. g. alignment and balancing of clutches, belt tension of a belt drive, backlash and crest clearance of a gear PTO drive, radial clearance),
- ▶ the minimum insulation resistance values and clearance values are maintained,
- ▶ the earthing and equipotential bonding values have been properly established,
- ▶ any bearing insulation is fitted in accordance with the labelling.
- ▶ all retaining bolts, connecting elements and electrical connections have been tightened to the specified torque,
- ▶ the rotor can spin without coming into contact with the stator,
- ▶ all shock protection measures for moving and live parts have been taken,
- ▶ if the second end of the shaft is unused, its featherkey has been secured so that it cannot fall out and the open shaft end is covered,
- ▶ all separately driven fans fitted are ready for operation and have been connected such that they rotate in the direction specified,
- ▶ the flow of cooling air is not impeded,
- ▶ all brakes are operating correctly,

- ▶ when operated on a converter, the motor can neither exceed the specified speed limit n_{max} nor under-shoot the specified limit value n_{min} .

If the design of the motor requires that the converter is a specific assigned type, the rating plate or certificate will contain corresponding additional information.

| | |
|---------------|---|
| Notice | This list does not claim to be exhaustive. It may be necessary to make additional checks and tests in accordance with the situation specific to the particular place of installation. |
|---------------|---|

4.6 Switching high-voltage motors

Overvoltages resulting from switching operations

When putting high-voltage motors or switchgears for high-voltage motors into service (3 kV to 12 kV), attention must be paid to the following because of possible overvoltages:

| | |
|----------------|---|
| Caution | Irrespective of the motor size and regardless of the turn-off principle of the circuit-breaker used, in other words even on small-oil-volume, SF6 or air-blast circuit breakers, shutdowns during motor start-up, for example, caused by faults in the starting control or by oversensitive protection settings, should be avoided if at all possible. Likewise, shut-downs during start-up for checking the direction of rotation or other tests should be kept to the absolute minimum. |
|----------------|---|

5 Operation

5.1 Safety instructions

Machine operation

| | |
|---|---|
|  Warning | <p>All covers that are designed to prevent active or rotating parts from being touched ensure compliance with a particular degree of protection, or that are required for ensuring proper air guidance and, in turn, effective cooling must not be opened during operation. All deviations from normal operation (higher power consumption, temperature or vibration level, unusual noises or odours, tripped monitoring devices, etc.) are indications that the motor is no longer functioning correctly. In this case, the maintenance engineer must be immediately notified in order to prevent disturbances that could either directly or indirectly lead to severe personal injury or substantial material damage. If in doubt, power down the motor immediately in accordance with the system-specific safety requirements!</p> |
|---|---|

| | |
|--|---|
|  Warning | <p>The surfaces of the machines can reach high temperatures, which can lead to burns if touched. That is why appropriate measures against accidental contact must be taken.</p> |
|--|---|

| | |
|----------------|--|
| Caution | <p>Motors in a protection class lower or equal to IP23 are generally not suitable for operation outside without additional protection.</p> |
|----------------|--|

Cleaning

To ensure proper functioning of the machine cooling system, the cooling circuits must be free of pollution (grilles, ducts, ribs, pipes).

5.2 Drives with insulated bearings

| | |
|----------------|---|
| Caution | <p>In the event that an insulated bearing is installed on the DE side, the local Helmke branch must be consulted prior to any replacements, modifications, maintenance or any other interference in the machine, etc.</p> |
|----------------|---|

5.3 Starting

- ▶ Prior to start-up, manually turn the rotor and listen for unusual noises.

| | |
|----------------|---|
| Caution | <p>The number of permitted starts depends strongly on the driven load. It is to determine for the specific drive system in any case. A too high number of starts or too short cool down phases lead to high temperatures in the machine especially in the rotor and can damage the machine shortly and also long-term. Depending on the machine design it is possible that the integrated temperature sensors (e. g. PTC or Pt100) do not show this. As a guideline a maximum of 1000 starts per year can be obmitted for typical applications.</p> |
|----------------|---|

- ▶ Star-delta start: The switching timer must be set so that the continued switching from star to delta only occurs after exceeding the breakdown torque, therefore after completing the star starting current. Other conditions can be provided in special cases only after consulting us after checking the run-up time, such as for fan drives with a greater moment of inertia.
- ▶ Softstarter: The use of a softstarter reduces the stress of the mechanical parts and for the feeding mains. They can only used, if the driven load needs low torque during start (e. g. fans with closed air inlet). The acceleration time rises. The thermal heating of the motor is always increased in comparison to direct online start. Respectively the number of permitted starts is reduced.
- ▶ It is recommended to initially idle the motor for one hour, i. e. not connected to the machine. A proper run is present, when no unauthorized vibrations or irregular bearing noises can be noticed. Tapping or knocking noises in the bearing areas lead to the conclusion to bearing damages (transport, extensive downtime). Screeching noises point to slipping rollers, possibly incompletely developed grease film – this can occasionally be observed in idling roller bearings, however, should have disappeared after a brief operating period. In addition to the listening stick or stethoscope for a subjective evaluation by an expert, portable measuring devices SPM 43 A or T 2000 can be applied for the bearing evaluation via the SPM method. Various design models of the motor housings must be considered for the volume of all running noises (cast iron machines always appear to be quieter than welded steel structures with tubular condensers).

| | |
|----------------|--|
| Caution | <p>Motors with cylindrical roller bearings need a specific minimum bearing load. For vertical machines this is not given without coupled driving elements. An unloaded test run must be carried out in horizontal position or with pressure roller depending on the type of the axial thrust bearing. Otherwise a quick bearing damage may occur. In case of doubt ask the manufacturer.</p> |
|----------------|--|

- ▶ Our motors were also tested for their smoothness of operation prior to delivery. If unexplained vibrations are still encountered, the motor must first be separated from the load machine and restarted to limit the cause. If the smoothness of operation is still unsatisfactory, the clutch or pulley may not correspond with the respective balance condition (half key / full key balancing) of the motor, or the characteristic frequency of

the foundation is too close to the motor rotational frequency. In order to properly check the balancing quality of the motor, it would have to be operated with a free shaft and a half (or full) key on a neutral base (such as rubber plates or rubber-bonded metals) or suspended from a crane and the vibration speeds (mm/s) must be measured. According to experience, foundation problems almost only occur in 2-pole motors i. e. drives operating at 3,000 / 3,600 rpm.

- ▶ Coupled and therefore only slightly radially stressed motors sometimes still have unexpected vibrations despite proper balancing. A “jumping” of the rotor within increased bearing clearance could be the problem. Possible remedy other bearings with a reduced play. For machines with 2 deep-groove ball bearings, of which the one is installed axially movable as movable bearing: Preset this bearing with disk springs or such.
- ▶ Roller bearings receive the required grease quantity of an optimal quality prior to the motor delivery as initial lubrication (request specifications, if necessary).
- ▶ Sleeve bearings are delivered without an oil fill.
- ▶ The lubrication and maintenance instructions must be observed for the roller and sleeve bearings.
- ▶ The temperature of the roller bearings can be up to 50 K above the coolant temperature of 40 °C – higher values up to an operating temperature of 140 °C are possible under certain circumstances after consultation.
- ▶ The operating temperature of sleeve bearings should not be greater than 75 °C during continuous use (approx. 10 K higher, if this measurement is made directly in the lower shell) – contact is necessary for special cases. The temperature of sleeve bearings specifically should be constantly monitored; Pt100 measurement resistors are generally installed there.
- ▶ All machines with removable covers on plug-in type bearings or housings require verification that these remain closed, since a perfect ventilation is otherwise not guaranteed and unauthorized heating may occur.

5.4 Operation

Vibrations according to DIN ISO 10816-3 within the “satisfactory” range ($v \leq 4.5$ mm/s) are inoffensive during the coupled operation. The machine must be switched off in the event of doubts in case of any changes from the normal operation – such as increased temperatures, noises, vibrations. Determine the cause, possibly contact the manufacturer. Safety equipment may not be disconnected even during trial operations. Clean the cooling equipment routinely in case of extensive contamination.

5.5 Stoppages

If the motor remains out of service for an extended period of time (> 1 month), it should be started up about once a month or at least the rotor should be turned. Refer to the instructions in chapter 5.3 – ‘Starting’ on page 5-1 before restarting the motor. If

a rotor locking device has been attached to the motor, you must remove it before you spin the rotor.

| | |
|----------------|---|
| Caution | If the motor is not to be used for a period in excess of 12 months, suitable anticorrosion, mothballing, packaging and drying measures must be taken. |
|----------------|---|

Switching on the anti-condensation heating

If an anti-condensation heating is provided, switch it on during the machine stoppages.

Taking the machine out of service

For details of required measures see chapter 3.2 – ‘Storage’ on page 3-2.

Shaft earthing device

If non-standard shaft grounding devices are used at the non-drive end shaft end / bearing unit with brushes in a design that is not encapsulated and sealed, corrosion can occur on the brush track (shaft) during lengthy stoppages. The corrosion must be removed when the machine is put (back) into operation.



Lubrication prior to recommissioning

| | |
|----------------|---|
| Caution | <p>If the motor has not been used for longer than 12 months, it must be regreased before being restarted. The shaft must rotate so that the new grease can be distributed throughout the bearings.</p> <p>Pay attention to the instructions on the lubrication plate.</p> |
|----------------|---|

6 Maintenance

6.1 Preparations for maintenance

Instructions relevant to safety

| | |
|--|---|
|  Warning | <p>Before starting any work on the motors ensure that the plant or system has been deenergised and locked-out against re-closure in full compliance with all of the appropriate specifications and regulations. In addition to the main circuits, also make sure that supplementary and auxiliary circuits are isolated from the supply, especially the anti-condensation heater.</p> <p>Certain parts of the machine may reach temperatures above 50 °C. Physical contact with the machine could result in burn injuries! Check the temperature of parts before touching them.</p> <p>When cleaning the machine, ensure that suitable exhaustion measures are used and you use personal protective gear (e. g. goggles, face mask / filter).</p> <p>If chemical cleaning agents are used, observe the instructions and any warnings indicated on the associated safety data sheets. Chemical agents must be compatible with the motor's components/parts, especially when they contain plastics.</p> |
|  Danger | <p style="text-align: center;">Explosion hazard</p> <p>If you clean the machine with compressed air, plastic components may become statically charged and create a potentially explosive atmosphere. Do not clean plastic components with compressed air. When cleaning the machine, make sure that the air in the vicinity of the motor is free of gas and dust.</p> |
| Notice | <p>Operating conditions and characteristics can vary widely. For this reason, only general maintenance intervals can be specified here.</p> |

6.2 Cleaning the motor

When cleaning the motor, care must be taken above all to clear dirty and possibly blocked airways and cooling surfaces. The end plates and the respective covers should be removed from motors in protection class IP23. The machine should be cleaned with dry air (compressed air or bellows). Avoid blowing dust into the bearings. The pressure may not be too high that also no dust forced through the bearing seal.

6.3 Lubrication and maintenance instructions for roller bearings

General

Roller bearings are precision parts. A suitable lubrication is decisive in any case for the operational safety. Low-vibration operation and adherence to the respective bearing loads are an absolute requirement.

The grease quality listed on the lubrication labels must be used for re-lubrication. This prevents bearing damages due to incorrect lubrication use. The mentioned lubrication intervals must also be adhered to; excessively greasing the bearings is also detrimental. Difficult operating conditions may require corrections – we therefore request that you contact us.

| | |
|---------------|---|
| Notice | The bearing grease loses its excellent lubricating characteristics at least after 4 months after the machine shutdown period, if it has not been refilled since the shutdown. |
|---------------|---|

Machines without a grease nipple

The first fill is generally sufficient for the service life of the bearing. If re-lubricating is required after an extended shutdown period, the used grease must be completely removed, whereby the bearing cover and the bearing must be carefully cleaned with gasoline or degreaser. Then coat the roller bearings with fresh grease and fill both bearing covers sufficiently with grease. Excessive grease results in unauthorized heating of the roller bearings and must therefore be avoided at all costs.

A light rotation of the rotors should be checked manually after the bearing covers have been re-attached. An observation during the start-up is recommended: Noises? Excessive heating of the bearings over a longer period?

Machines with grease nipples and without a used grease removal

A reference tag is attached on the motor, on which the grease quantity and the intervals for regreasing are listed. After several times of regreasing, the outer bearing covers must be removed and the used grease must be removed.

A light rotation of the rotors should be checked manually after the bearing covers have been re-attached.

| | |
|---------------|---|
| Notice | Only re-grease the machine while the machine is operating, if necessary, provide lubricating tube extensions. Access tubes must always be filled with grease! |
|---------------|---|

Machines with grease nipple and automatic grease quantity adjustment

Re-grease while machine is running. Reference tags are attached for regreasing. An installed spinner disk hurls the used grease pressed out of the roller bearings, which accumulates in a chamber. These are arranged as follows and will be emptied in the manner listed in the following. Conduct the first check after 2...3 hours. The bearing covers do not have to be dismantled.

- ▶ Grease chamber under the fan cover on the drive end side
→ Remove screws, pull out the grease chamber and empty
- ▶ Grease chamber under the outer bearing cover
→ Pull out the drawer, empty the chamber
- ▶ Grease chamber under the inner bearing cover

- Reach into the bearing end plate opening, pull out the drawer, empty the chamber
- ▶ Horizontal tube under the fan cover on the drive side
 - Unscrew both plugs, push out used grease with a rod

| | |
|---------------|---|
| Notice | <p>Excessive grease quantities may result in increased bearing heating! The excess grease is discharged only after hours. The instructions apply accordingly for other models.</p> <p>Grease with a viscosity of (< 130 cSt) should be used for 2-pole machines due to the high temperatures during the start.</p> |
|---------------|---|

| | |
|---------------|---|
| Notice | <p>We recommend Mobil UNIREX™ N3 as standard lubricant. Although the bearings are lubricated in the manufacturing plant, the new bearings must be re-lubricated after a few days of operation, in order to guarantee a long service life.</p> <p>If the lubricating intervals become very short due to a high bearing temperature (> 85 °C), high temperature grease should be used.</p> |
|---------------|---|

Machines with automatic re-greasing device

Automatic re-greasing devices are usually used when the bearing load is very high and the lubrication intervals are correspondingly short. They can also be used to define a general maintenance interval independent of the lubricating interval.

A lubricant dispenser provides continuous lubrication over a predefined period of time during operation.

| | |
|----------------|--|
| Caution | Note the details of the re-greasing device manufacturer regarding storage, specific environmental conditions, grease filling, adjustment, operation modes, power supply and supervision. |
|----------------|--|

| | |
|---------------|---|
| Notice | <p>Replace the lubricant reservoir in time. Remove the used grease in the grease chamber depending on the size of the lubricant reservoir, regular lubrication intervals and the respective lubricating volume.</p> <p>Also while using this automatic re-greasing device, pay attention to all instructions in this whole section.</p> |
|---------------|---|

Miscibility

| | |
|----------------|---|
| Caution | When changing from one grease type to another, it is important to observe the miscibility of the greases. If incompatible greases are mixed together, the composition can be changed dramatically and the maximum approved operating temperature of the grease mixture can be so low in comparison to the original grease that bearing damages cannot be ruled out. |
|----------------|---|

Greases that have the same soap and use similar basic oil can generally be mixed without any hazardous results. Grease based on lithium can be mixed with other grease based on lithium. Grease based on calcium and lithium generally can be mixed, however, not with one based on sodium. Mixtures can reduce the drop point of the mixtures. Modern high-performance grease loses its generally good characteristics when mixing with other grease. A perfect operation of the machine should be checked by applying a listening stick or SPM measuring device before and after each lubrication process.

6.4 Maintenance instructions for sleeve bearings

| | |
|----------------|--|
| Caution | When working on bearings it is important to ensure absolute cleanliness. The oil lubrication rings and seals are to be handled carefully. Damage and deformation are to avoid. |
|----------------|--|

The first oil change shall be made after 600 to 700 operating hours. The oil change intervals and oil viscosity are indicated on an instruction plate on the motor. The change intervals are shortened through frequent starts, high lubricating oil temperatures or excessive pollution caused by external influences. Apart from the oil tightness the oil and the oil flow rate, the cleanliness of the filter should be checked regularly.

For an oil change, drain the oil and clean all components. Defective parts and filters should be replaced if necessary. Subsequently, oil is to be filled according to the instructions for start-up. After the start, the bearings have to be monitored according to these instructions (see chapter 4.4 – ‘Start-up of sleeve bearings’ on page 4-6).

The outer bearing housing must be kept clean in order not to disturb the heat transfer through the fins, particularly in naturally cooled bearings.

For water cooling of the bearings, the maintenance instructions of water-cooled machines apply in addition to the above.

6.5 Maintenance instructions for freestanding drives

High voltage machines, which are shut down over an extended period under extreme climatic conditions (room temperature of 40...45 °C and relative humidity of more than 95 %), can still be operated at an insulation resistance of 0.5 MΩ, if they are otherwise clean.

When operating the motors outdoors without a protective roof (only possible for motors with a minimum protection rate of IP44 and a normal climate), an increase maintenance requirement is necessary, especially in case of extended shutdown periods. These motors must be operated for at least one hour monthly to reduce corrosion due to condensate and rain water. When shutting down the motors during winter, blocking the outer fan by snow and ice must be prevented.

6.6 Servicing

6.6.1 Servicing instructions

Faults

An inspection must be carried out as soon as faults or exceptional operating conditions that exert an excessive load (either electrically or mechanically) on the motor (e. g. overload, short circuit) occur.

| | |
|-------------|--|
| Note | When servicing a motor with rolling-contact bearings, it is generally not necessary to dismantle it. The motor only has to be dismantled if the bearings are to be replaced. |
|-------------|--|

| | |
|----------------|--|
| Caution | The required regreasing intervals for rolling-contact bearings are not the same as the servicing intervals. It is essential to adhere to them. |
|----------------|--|

| | |
|----------------|---|
| Caution | The spent grease chambers of the rolling-contact bearings only have enough room to take up a limited amount of spent grease. When the grease chamber is full, you must remove the spent grease before re-lubricating, because it will otherwise escape into the inside of the motor. Escaping oil at the bearing or oil escaping during regreasing is an indicator that the space for the spent grease is full. |
|----------------|---|

6.6.2 First service after installation or repair

After approximately 500 operating hours, at the latest after 1 year

Check, while the motor is running, that:

- ▶ the equipment conforms to the stated electrical characteristics,
- ▶ the permissible bearing temperatures are not exceeded,
- ▶ the smooth running characteristics and motor operating noise have not become worse.

Check, while the motor is at standstill, that:

- ▶ the motor foundation has no indentations or cracks.

Further checks may be required in addition as a result of additional operating instructions or in accordance with the plant-specific conditions. Any impermissible discrepancies or changes found during the checks must be rectified immediately.

6.6.3 General inspection

After approximately 16,000 operating hours, at the latest after 2 years

Check, while the motor is running, that:

- ▶ the equipment conforms to the stated electrical characteristics,
- ▶ the permissible bearing temperatures are not exceeded,
- ▶ the smooth running characteristics and motor operating noise have not become worse.

Check, while the motor is at standstill, that:

- ▶ the motor foundation has no indentations or cracks,
- ▶ the motor is aligned within the permissible tolerance ranges,
- ▶ all of the mounting bolts for the mechanical and electrical connections are tight,
- ▶ the winding isolation resistances are sufficiently high,
- ▶ if the bearings are insulated, the insulation has not been bridged,
- ▶ cables, insulating parts and components are in a good condition and are not discoloured.

6.7 Corrective maintenance

6.7.1 Preparations for overhauling / repairs

Instruction relevant to safety

| | |
|---------------|---|
| Notice | If the motor has to be transported, please observe the information and instructions in chapter 3.1 – 'Transport' on page 3-1. |
|---------------|---|

| | |
|---|--|
|  Warning | When working on the locating bearing when the motor is in its vertical position, support the rotor. Pay attention to the following points when attaching rotors: the centring recesses in the shaft ends according DIN 580 eye-bolts are unsuitable because only a few threads would be engaged. Depending on the weight of the rotor and the direction of the load, it may be necessary to use other suitable elements with an engagement length > 0.8 times the thread diameter. |
|---|--|

| | |
|---|--|
|  Warning | Note IEC/EN 60079-19 when carrying out work on explosion protected motors (see chapter 7.5 – 'Repairs' on page 7-6). |
|---|--|

6.7.2 Dismantling

The drawings and part lists do not include any detailed data about the type and dimensions of the fixing elements, etc.; when dismantling the motor, you should therefore make a note of where the parts belong and label them so that they can be easily reassembled.

Use pullers or suitable devices to disassemble parts and components attached to the motor shaft. Before you pull off screwed parts and components, replace two of the fixing screws in the top of the parts to be removed by long bolts or stud bolts, so that the parts are still supported after they have been removed.

Bearing bushes

We recommend that you label the components that comprise the active part of the bearing to ensure correct assembly.

| | |
|---|--|
|  Warning | <p>Support or unload the rotor when carrying out work at the thrust bearing with the machine in a vertical position.</p> |
|---|--|

6.7.3 Re-assembly

Sealing

Clean and coat the bare joints between the parts and components (e. g. between housings, end shields and bearing units) with a non-hardening, permanently flexible sealing compound, i. e. Hylomar MQ32 (follow the manufacturer's application and safety instructions!).

Check the existing sealing elements, i.e. at the terminal boxes. Renew them if they no longer provide a proper seal. Only use sealing elements that have been tested!

Installation of the rolling-contact bearings

Before fitting the bearings, ensure that the parts and components to be located on the shaft inside the bearing are fitted first.

Take great care and pay attention to cleanliness when installing and assembling the bearings. To fit the rolling-contact bearings, heat them up to about 80 °C in oil or air and then press them onto the shaft. Avoid any heavy blows that might damage the bearings. Fill the bearings with the specified grease so that they are flush.

6.8 Tightening torque of screw connections

Table 6-1 Tightening torque for screw connections of the electrical connections - terminal board connections (except terminal strips)

| Thread | M4 | M5 | M6 | M8 | M10 | M12 | M16 |
|------------|-----|-----|----|----|-----|-----|-----|
| Torque /Nm | 1,2 | 2,5 | 4 | 8 | 13 | 20 | 40 |

Table 6-2 Tightening torque for screws on the electrical connection box, end plates and protective earth conductor screw connections

| Thread | M4 | M5 | M6 | M8 | M10 | M12 | M16 | M20 |
|------------|----|----|----|----|-----|-----|-----|-----|
| Torque /Nm | 3 | 5 | 9 | 24 | 42 | 70 | 165 | 340 |

Table 6-3 Tightening torque for metal cable glands

| Thread | M12x1,5 | M16x1,5 | M25x1,5 | M32x1,5 | M40x1,5 | M50x1,5 | M63x1,5 |
|------------|---------|---------|---------|---------|---------|---------|---------|
| Torque /Nm | 6 | 7,5 | 9 | 12 | 12 | 14 | 14 |

Table 6-4 Tightening torque for plastic cable glands

| Thread | M12x1,5 | M16x1,5 | M25x1,5 | M32x1,5 | M40x1,5 | M50x1,5 | M63x1,5 |
|------------|---------|---------|---------|---------|---------|---------|---------|
| Torque /Nm | 3 | 3 | 3 | 6 | 6 | 6 | 6 |

6.9 Malfunctions

| Fault | possible cause | Remedy |
|---|--|--|
| Motor does not start | Supply is interrupted | Check the connections, links and terminals and correct, if necessary |
| | Fuse at the input feeder is blown | Search for cause and repair, replace fuse |
| | Motor protection device has been tripped | Check the motor protection device for the proper setting, information regarding power values on the rating plate |
| | Motor protection device does not switch | Check the control of the motor protection device |
| | Fault in the control unit or in the control process | Observe the switching sequence and adjust, if necessary |
| Motor does not start or only starts with difficulty | Motor performance is designed for delta connection, but is switched in star | Change connection from delta to star; observe circuit diagram |
| | Motor performance is designed for double-star connection, but is only switched in star | Change connection from double-star to star; observe circuit diagram |
| | Voltage or frequency greatly deviate from the rated value at least when switched on | Provide better power supply conditions, reduce the load of the power supply, check the cross-sections of the supply wiring, possibly install larger cross-sections |
| Motor will not start in star connection, only in delta connection | Torque for star connection is insufficient | If the starting current is not too high in delta (observe the supplier's specifications), switch on directly in delta Check project engineering and use possibly a larger motor or special type |
| | Contact error on the star-delta switch | Check switch, replace, if necessary; check connections |
| Incorrect direction of rotation | Motor is incorrectly connected | Change two phases of the supply wiring to the motor |
| Motor drones and has a high power consumption | Winding is defective | Motor has to go to repairs in the shop |
| | Rotor touches | |
| Fuses blow or motor protection trips immediately | Short circuit in the supply wiring to the motor | Eliminate short circuit |
| | Supply wirings are incorrectly connected | Adjust connection, observe circuit diagram |
| | Short circuit in the motor | Motor has to go to repairs in the shop |
| | Earth fault on the motor | |
| Great speed reduction under load | Overloading the motor | Measure load, check project engineering, use larger motor, reduce load |
| | Voltage drops | Check cross-sections of the supply wiring, possibly install larger cross-sections |

| Fault | possible cause | Remedy |
|--|--|---|
| Motor heats excessively (measure temperature) | Overload | Conduct performance measurement, check project engineering, use larger motor or reduce load |
| | Insufficient cooling | Improve cooling air supply and clear the cooling air paths, attach external fan, if necessary. Check air filter, clean or replace, if necessary |
| | Ambient temperature is too high | Observe the approved temperature range, possibly reduce load |
| | Motor switched in delta instead of star, as intended | Correct connection, observe circuit diagram |
| | Supply wiring has a loose contact (one phase is missing) | Repair loose contact, check connections; observe circuit diagram |
| | Fuse at the input feeder is blown (one phase is missing) | Search for cause and repair, replace fuses |
| | Supply voltage deviates more than 5 % (range A / 10 % (range B) according IEC/EN 60034-1 from the motor rated voltage. | Adjust motor to the supply voltage |
| | Rated operating mode (S1 to S10, IEC/EN 60034-1) exceeded, i.e. due to excessive switching frequency | Adjust the rated operating mode of the motor to the required operating conditions; possibly consult an expert to determine the proper drive application |
| Noise too high | Ball bearing is braced, contaminated or damaged | Align the motor and the machine, inspect the roller bearings, replace the roller bearings, if necessary |
| | Vibration of rotating parts | Search for cause, possibly imbalance, repair, observe the balancing method |
| | Foreign particles in the cooling air paths | clean cooling air paths |

7 Additional Instructions for Explosion-Proof Motors

7.1 General

The operation of the motors is subject to the regulations for electrical systems in areas subject to a risk of explosions. The requirements according to IEC/EN 60079-14 must be observed when setting up the motors. Determining the degree of the explosion risk of a fixed establishment is exclusively the responsibility of the respective national supervisory authority.

The regulations of the country of use apply for setting up.

7.2 System-specific ignition hazards

The criteria for the respective zonal classification as well as the respective proposed types of ignition protection are not harmonized (e. g. IEC/EN 60079-10-1 and IEC/EN 60079-10-2 as well as IEC/EN 60079-14) and the assessment of the operational risks, the local operating conditions and the various monitoring methods is not uniform and depending on national regulations in the country of use. Accordingly, the remedial measures recommended by the supervisory authorities also differ in some cases, depending on the authority's area of responsibility. The motor manufacturer cannot provide general recommendations in this regard.

| | |
|--|---|
|  Danger | <p>Note the strict compliance with all technical data for the specific motor in the documentation and on the nameplate. Otherwise, it may result in a risk of ignition e. g. by increased temperatures. The information in a certificate of a notified body (e. g. EU type-examination certificate) may be general limits and are subject to specific conditions.</p> |
|--|---|

Motors in type of ignition protection Ex ec, Ex eb and Ex nA

| | |
|---|---|
|  Warning | <p>Binding clarification of the on-site risks and of any required measures can only be provided by the system operator in agreement with the supervisory authority responsible. The risk assessments from standards IEC/EN 60079-14 and IEC/EN 60079-7 resp. IEC/EN 60079-15 must be used to assess the system-specific ignition hazards.</p> |
|---|---|

If the result of the risk assessments is insufficient you must ensure that explosive air does not enter the motor housing during the start-up phase. If this cannot be ensured you are advised to purge the motor housing. The motor is equipped with a purge-air inlet and outlet for this purpose. For information about the purge characteristics and the position of the purge-air inlet and outlet, see the notices on the motor housing. Seal the openings before switching on the motor.

Motors in closed design without pre-purging

Due to the closed design of the machine housing, the interior is not connected to the ventilation requirements at the set-up location of the machine. This means that the possibility exists that the criteria for the classification of the zone according to IEC/EN 60079-10-1 are not in compliance in the interior of the machine housing.

In order to prevent an explosive atmosphere from penetrating or being drawn into the motor frame during stoppages or short-term shutdowns, it may be advisable to initiate suitable measures after shutdown in agreement with the supervisory authorities, such as generating an overpressure (recommended: ≥ 50 Pa; ≥ 0.5 mbar) inside the frame to compensate for leakage losses, or providing suitable ventilation of the installation site (see information notes in IEC/EN 60079-10-1). A tapped hole may be provided in the intermediate housing under the main terminal box for connecting a pipe to prevent a negative pressure being created inside the motor frame. The tapped hole is labelled with a plate and sealed with a screw plug.

Danger due to electrostatic discharge

Electrostatic discharges are a potential source of ignition. Electrostatic charges can be caused, for example, by mechanical friction, particle-laden air flow or unearthed persons.

| | |
|---|---|
|  Warning | <p>Electrostatic discharges can cause an explosion.</p> <ul style="list-style-type: none"> ▶ Observe ESD protective measures. ▶ Avoid working on non-metallic parts, for example on insulating materials for noise damping. |
|---|---|

The standard version of the machines is generally suitable for use in hazardous areas regarding the paint system. In case of deviations, the final electrostatic verification of the entire system is the responsibility of the user.

Risk of damage of the sealings

If machines are stored outside the specified ambient conditions and temperature limits, the seals and in particular the sealing materials may be damaged and the sealing functions may fail.

If the pressure relief devices in terminal boxes of high-voltage machines with Ex e and Ex t type of protection are damaged, water and foreign particles can penetrate.

| | |
|---|---|
|  Warning | <p>If the IP protection types of the terminal boxes and so the certified ignition protection types of the machines are not guaranteed, this can lead to a short circuit and an explosion in a potentially explosive atmosphere.</p> |
|---|---|

7.3 Assembly and connection

Observe the requirements in IEC/EN 60079-14.

Protection against increased temperature

To maintain the thermal class the machine must be equipped with a functionally-tested protection device that disconnects all three phases simultaneously.

A current-dependent, time-delayed protective device must trip the machine within 2 hours at 1.2 times the their rated current and must not release within 2 hours at 1.05 times their rated current. They must also be chosen in such a way that the motor is also thermally protected in the event of a short circuit (i. e. with a locked rotor).

If winding and bearing temperature are monitored, the sensors must be connected to functionally-tested tripping units. Intrinsically safe circuits are clearly marked, possibly colour-coded in light blue. The respective operating instructions of the components must be observed. Unused connection cables are to ground.

Check always the bearing temperature at start-up.

Only the on the nameplate or in the technical data specified thermal class (in case of specification of two classes, the smaller one) or maximum temperature difference must be used.

Unless otherwise stated on the nameplate or in the specifications, the voltage-frequency limits of the zone A in IEC/EN 60034-1 applies.

Anti-Condensation heater

The supply of an anti-condensation heater must be independent from the motor supply. The voltage must conform to the specified in the documentation and on the nameplate.

| | |
|--|--|
|  Warning | <p>The anti-condensation heater must not be switched on when the motor is in operation.</p> <p>Switch on the standstill heating only approx. two hours after switching off the machine, otherwise the temperature class or the maximum surface temperature of the machine may be exceeded.</p> |
|--|--|

Cable entries

The execution of cable entries depend on the connection method and scope of the order. Cables, wires, sealing, glands and area of use must be coordinated.

The used components must be certified and labeled as being suitable for utilization in the appropriate zone with the necessary IP class and ignition protection type. Not used entries must be closed by qualified and if required certified components. Note that the installation and operation conditions possibly specified in the respective certificate must be observed and check that this is the case.

Frequency converter operation

All rules of IEC/EN 60079-14 must be observed in particular concerning the operation on an inverter. In general, a close coordination with HELMKE is required.

Motor with external fan

For a motor with external fan must be ensured that the motor can only be switched on when the external fan is in operation. The fan drive itself must have the corresponding needed type of ignition protection for the appropriated zone and subject to all the information in this manual.

Purging

| | |
|---|--|
|  Warning | <p>Air may be used as the protective gas, which satisfies the requirements of the Ex p system manufacturer. If a protective gas other than air is used, special care must be taken to prevent the operating personnel from being harmed by the gas escaping under field conditions during purging and operation.</p> |
|---|--|

Terminal boxes in type of ignition protection Ex d

Depending on specific requirements regarding the national laws and rules in the country of use the electrical installation must be done by specific educated staff.

| | |
|----------------|--|
| Caution | <p>Open the terminal box with care and using the proper tools to avoid any even small damages or deformation of the flameproof joints and crossings.</p> |
|----------------|--|

Please note that all flameproof joints must not have damages at any time. Every part with rust or damaged areas must be replaced by original parts. Areas of flameproof joints shall be protected by oil or grease against corrosion.

| | |
|----------------|---|
| Caution | <p>The cable connection must always be done via certified cable entries with type of protection flameproof enclosure Ex d.</p> <p>To close unused openings, only use tested and certified plugs with the appropriate type of protection.</p> <p>Note IEC/EN 60079-14.</p> |
|----------------|---|

Terminal boxes in type of ignition protection Ex e

If the machine is equipped with terminal boxes by the type of protection increased safety for both the main terminal box and the auxiliaries then aware:

| | |
|----------------|---|
| Caution | <p>The cable connection must always be done via certified cable entries with type of protection increased safety Ex e.</p> <p>To close unused openings, only use tested and certified plugs with the appropriate type of protection.</p> <p>Note IEC/EN 60079-14.</p> |
|----------------|---|

Terminal boxes in type of ignition protection Ex t

If the machine is equipped with terminal boxes by dust ignition protection by enclosure Ex t for both the main terminal box and the auxiliaries then aware:

| | |
|----------------|---|
| Caution | <p>The cable connection must always be done via certified cable entries with dust ignition protection by enclosure Ex t.</p> <p>To close unused openings, only use tested and certified plugs with the appropriate type of protection.</p> <p>Note IEC/EN 60079-14.</p> |
|----------------|---|

Cable connections

| | |
|---|--|
|  Warning | <p>If cable lugs are used, they can twist during connection. The minimum clearances may then not be achieved. A short circuit may occur.</p> <p>With Ex e and Ex t types of protection, hot gas or plasma can escape explosively via the joints of the terminal boxes or the pressure relief devices in the terminal boxes of high-voltage machines, which can lead to an explosion in a potentially explosive atmosphere.</p> |
|---|--|

If conductor ends are not properly enclosed by a cable lug or ferrule and properly clamped to it, overheating can occur.

The same applies to clamp connections with insufficient contact pressure due to increased contact resistance.

Aluminium in particular flows after assembly. Retighten the connections after about 24 hours and after 4 weeks.

| | |
|---|---|
|  Warning | <p>If the cable connections are loose, the temperature classes of the machines may be exceeded.</p> <p>This can lead to an explosion in a potentially explosive atmosphere.</p> |
|---|---|

7.4 Operation

Cleaning the motor

| | |
|---|--|
|  Warning | <p>If the motor is tagged with markings regarding the risk of electrostatic charges e. g. "WARNING – POTENTIAL DANGER OF ELECTROSTATIC CHARGE – READ SAFETY INSTRUCTIONS", no cleaning with compressed air or bellows is admissible in areas subject to a risk of explosions. The cleaning must be made manually using a damp cloth.</p> |
|---|--|

Check bearing condition

Lubricate anti-friction bearings regularly in accordance with the lubrication plate.

Use a bearing temperature monitoring system wherever possible.

Carry out occasional vibration monitoring to check bearing condition. Replace when deterioration is detected.



Warning

In case of a bearing fault, localised overheating and, as a result, an explosion in an explosive atmosphere may occur.

7.5 Repairs

For overhauling and repair a service center must be chosen, which has knowledge of all specific requirements regarding the national laws and rules in the country of use.

All relevant parts regarding the ignition protection must be generally replaced by original spare parts in accordance with the certification documents. This applies particularly to e. g.:

- ▶ screws (identical strength class e. g. class 8.8 or class 12.9)
- ▶ replacement of seals, repair of flame proof joints and crossings
- ▶ repair or replacement of fans or fan covers,
- ▶ bearing replacements,
- ▶ replacement of the terminal elements,
- ▶ change of cable glands,
- ▶ replacement of heaters,
- ▶ new painting.

All changes regarding the ignition protection e. g. modifications of the windings must be agreed by the manufacturer or in an exceptional case with the notified body.

Observe the special conditions in the examination certificates.

The joint dimensions of flameproof enclosed electrical machines do not always comply with the minimum requirements of IEC/EN 60079-1. Modifications to the joint geometries are not permitted.

After working close to the fan wheel and air guide nozzle, sparks may occur due to touching. Check the radial circumferential gap in accordance with the certification documents or standard specifications.



Warning

If parts other than original parts in accordance with the certification documents are used, the type of ignition protection is no longer guaranteed.

This can lead to an explosion in a potentially explosive atmosphere.

All overhauling and repair activities have to be documented and the machine must be labelled with an additional plate.

IEC/EN 60079-17 describes the inspection and maintenance of electrical installations in potentially explosive atmospheres. IEC/EN 60079-19 gives general instructions for equipment repair, overhaul and reclamation. For the reassembly consider IEC/EN 60079-14.

7.6 Bridging the bearing insulation

A bearing insulated on the DE side is generally bridged electrically conductive, in order to maintain the rotor at the housing potential.

| | |
|---|---|
|  Warning | <p>Removing the factory installed existing bridging of the insulated DE bearing results in potential differences between the rotor and the grounded machine. This may produce sparks, which will ignite the surrounding gas especially in an atmosphere subject to explosions. There is also a risk of electric shock.</p> <p>The bridging of the bearing insulation on the DE side may not be opened during operation.</p> |
|---|---|

The shaft is ground on the DE or NDE side via a shaft grounding device on special models, also during the operation on the converter.

| | |
|---|---|
|  Warning | <p>The bridging of the insulated bearing in models with shaft grounding devices and insulated bearings on the DE and NDE side results in electrical current flow via the machine housing.</p> <p>The bearing insulation of the insulated bearings may not be electrically bridged during operation. Keep the insulation points clean.</p> |
|---|---|



EU-Konformitätserklärung *EU Declaration of Conformity*

Die Firma: J. Helmke & Co.
The company: Ludwig-Erhard-Ring 7-9
31157 Sarstedt

erklärt als verantwortlicher Hersteller, dass
declares as responsible manufacturer, that

die Produkte: 3-Drehstrommotor, **Helmke**
the products: 3-phase induction motors, **HELMKE**

Type: **.NDOR...**

Den folgenden grundlegenden Richtlinien entsprechen:
are in conformity with the following Directives:

ATEX Richtlinie 2014/34/EU
ATEX Directive 2014/34/EU

Ökodesign-Richtlinie 2009/125/EG (Verordnung (EU) 2019/1781 inkl. 2021/341)
Ecodesign Directive 2009/125/EU (Commission Regulation (EU) 2019/1781 incl. 2021/341)

RoHS-Richtlinie 2011/65/EU (inkl. Delegierte Richtlinie (EU) 2015/863)
RoHS Directive 2011/65/EU (incl. Delegated Directive (EU) 2015/863)

Angewendete Normen:
Applied standards:

EN IEC 60079-0:2018/AC:2020-2, EN IEC 60079-7:2015/A1:2018
EN 60204-1:2018, EN 60034-1:2010+COR.:2010
EN 60034-2-1:2019, EN 60034-30-1:2014
EN IEC 63000:2018

Die Produkte gelten als sicher für die Anwendung in explosionsgefährdeten Bereichen. Dies gilt auch für die Verwendung in nicht explosionsgefährdeten Bereichen. Daher können die Produkte als konform und sicher im Sinne der Niederspannungsrichtlinie 2014/35/EU angesehen werden.
The products are regarded to be safe for use in explosive atmospheres. This includes also the use in non-potentially explosive atmospheres. Therefore, the products can be deemed to be compliant and to be safe in the sense of Low Voltage Directive 2014/35/EU.

Die Produkte sind zum Einbau in andere elektrische Betriebsmittel oder eine Maschine vorgesehen (siehe §7 des Leitfadens zur Niederspannungsrichtlinie 2014/35/EU sowie entsprechend §§54 und 55). Ihre Inbetriebnahme ist so lange untersagt, bis festgestellt wurde, dass die Maschine, in die die Produkte eingebaut werden sollen, den Bestimmungen der Maschinenrichtlinie 2006/42/EG entspricht.
The products are designed for incorporation into other equipment or machinery (see §7 of the Guidelines to the Low Voltage Directive 2014/35/EU as well as §§54 and 55). Bringing into service is prohibited until the machinery into which the products have been incorporated was declared in conformity with the Machinery Directive 2006/42/EC.



Kurzschlussläufermotoren sind laut Leitfaden zur EMV-Richtlinie, Abschnitt 1.4.4 Betriebsmittel mit unkritischen physikalischen Eigenschaften des Kapitels I, Artikel 2, Abschnitt 2d) der EMV-Richtlinie 2014/30/EU auf die die Richtlinie keine Anwendung findet. Eine CE-Kennzeichnung bezüglich dieser Richtlinie ist nicht erforderlich.

According to the guideline for EMC-Directive, chapter 1.4.4 squirrel-cage induction motors are equipment with inherent nature of the physical characteristics subject to the Chapter 1, Article 2, Paragraph 2(d) of the Directive 2014/30/EU to which the directive shall not apply. A CE marking regarding this directive is not necessary.

Diese Erklärung erfüllt die Anforderungen der EN ISO/IEC 17050-1:2010 für eine Bestätigung durch die erste Seite.

This declaration meets the requirements of EN ISO/IEC 17050-1:2010 for an attestation by the first party.

Diese Erklärung bescheinigt die Übereinstimmung mit den genannten Richtlinien, beinhaltet jedoch keine Zusicherung von Eigenschaften im rechtlichen Sinne.

This declaration certifies the conformance with the above mentioned directives. Affirmation of attributes in a legal sense is not included.

Die Sicherheitshinweise der zugehörigen Produktdokumentation sind zu beachten.

The safety instructions given in the product documentation have to be observed

Dr. Ralf Briest

Ort / Datum: Sarstedt, 31. März 2022

Place / Date: Sarstedt, March 31st, 2022

Leiter Technik
Technical Director

Three-phase induction motor with squirrel cage rotor
 Drehstromasynchronmotor mit Kurzschlußläufer

Electrical data / Elektrische Daten

| | | | | |
|--|-----|-------------------------|-------|-------|
| Rated motor power / Bemessungsleistung | kW | 2,5 | | |
| Rated motor voltage / Bemessungsspannung | V | Δ 400 | Y 690 | |
| Rated voltage tolerance / Bemessungsspannungsbereich | | Zone A (V: ±5%; f: ±2%) | | |
| Rated frequency / Bemessungsfrequenz | Hz | 50 | | |
| Number of poles / Polzahl | | 4 | | |
| Rated motor speed / Bemessungsdrehzahl | rpm | 1450 | | |
| Rated motor current / Bemessungsstrom | A | 5,1 | 2,9 | |
| Power factor / Leistungsfaktor (at / bei 100% - 75% - 50%) | | 0,80 | 0,73 | 0,60 |
| Efficiency / Wirkungsgrad (at / bei 100% - 75% - 50%) | | 87,7% | 88,1% | 87,1% |
| Efficiency / Wirkungsgrad | | IE3 | | |
| Breakdown-/Rated torque / Kipp-/Bemessungsmoment (Tb/Tn) | | 4,5 | | |
| Starting-/Rated torque / Anzugs-/Bemessungsmoment (Ts/Tn) | | 3,7 | | |
| Starting-/Rated current / Anzugs-/Bemessungsstrom (Is/In) | | 9,6 | | |

Mechanical data / Mechanische Daten

| | | | | |
|---|------------------|-----------------------|---|---|
| Weight / Gewicht | kg | 40,0 | | |
| Rotor inertia / Rotorträgheitsmoment | kgm ² | 0,01 | | |
| Direction of rotation (from DE side) / Drehrichtung (von A-Seite) | | both / beide | | |
| Balance / Wuchtart | | Half-key / Halbkeil | | |
| Vibration grade / Schwinggrößenstufe | | A | | |
| Bearing / Lagerart | | Anti-friction bearing | | |
| Bearing type DE / Lagertyp AS | | 6306 2Z C3 | | |
| Relubrication DE / Nachschmierung AS | h | - | g | - |
| Bearing type NDE / Lagertyp BS | | 6306 2Z C3 | | |
| Relubrication NDE / Nachschmierung BS | h | - | g | - |
| Grease type / Fettsorte | | Esso Unirex N3 | | |

General data / Allgemeine Daten

| | | | | |
|---|-------|---------------------|--|--|
| Frame size / Baugröße | | 100L | | |
| Type of construction / Bauform | | IM B3 | | |
| Material of housing / Gehäusematerial | | Cast iron / Grauguß | | |
| Material of terminal box / Klemmenkastenmaterial | | Cast iron / Grauguß | | |
| Degree of protection / Schutzart | | IP55 | | |
| Method of cooling / Kühllart | | IC411 | | |
| Thermal class - temperature rise / Wärmeklasse - Erwärmung | | F / B | | |
| Duty type / Betriebsart | | S1 | | |
| Sound pressure level, no load at 1 m / Schalldruckpegel, Leerlauf bei 1 m | dB(A) | 67,0 | | |
| Painting / Anstrich | | RAL 5010 | | |
| Standards / Normen | | EN 60034-1 | | |
| Ex-Protection / Ex-Schutz | | Ex ec IIC T3 Gc | | |

Site conditions / Aufstellbedingungen

| | | | | |
|---|----|------|-----|--|
| Ambient temperature / Umgebungstemperatur (min / max) | °C | -20 | +48 | |
| Max. altitude above sea level / Max. Höhe über NHN | m | 1000 | | |

Accessories / Zubehör

| | | | | |
|--|---|----------------------|---|---|
| Thermal protection / Temperaturüberwachung | | 3 x PTC / Kaltleiter | | |
| Space heater / Stillstandsheizung | V | - | W | - |

The rating plate values may vary from the calculated values. / Abweichungen zwischen berechneten und Leistungsschilddaten sind möglich.



PRÜFUNGSNACHWEIS / TEST CERTIFICATE

| | | | |
|-------------------------------|----------------|-----------------|-------|
| Fabrikat Make | HELMKE | | |
| Type | NDOR100L-04-3G | | |
| KLN | Nr. No. | 11000104292 | |
| D400 / Y690 v | | 5,1 / 2,9 A | |
| 2,5 kW | | cos φ | 0,80 |
| 1450 min^{-1} rpm | | 50 Hz | |
| U ₂₀ | V | I ₂ | A |
| Wkl Th.Cl | F | IP 55 | 40 kg |
| EN 60034-1 | | | |
| -20°C ... +48°C | | Ex ec IIC T3 Gc | |

| | | |
|---------------------------|--------------------------------------|-------|
| Kunde / Customer | DELTA GmbH | |
| Auftrag - Nr. / Order-no. | 11042400635 | |
| Ident - Nr. / Ident - no. | 11000104292 | |
| Maschinenart / Kind | 3-Ph - Kl - Mot. / 3-ph - sqc - mot. | |
| Lager Bearings | AS / DE 6306-2Z C3 | |
| | BS / NDE 6306-2Z C3 | |
| Kühlart Cooling | IC 411 | |
| Betriebsart Duty type | S1 | |
| | Bauform Frame type | IM B3 |

Prüfungen / Tests

| | | | | |
|---|---------|--------|-------------------------------------|-------------------------------|
| Wicklungswiderstände bei Winding resistance at | 27,8 °C | Stator | U1 – V1; V1 – W1; U1 – W1 | 4,682 / 4,607 / 4,629 Ω |
| | | Rotor | | Ω |
| Hochspannungsprüfung High-voltage test | | Stator | 2,895 kV | 60 sek / sec |
| Leerlaufprüfung No - load test | | | 400,200 v 399,100 v 400,700 v | 2,840 A 2,760 A 2,770 A |
| | | | | 191,200 W 50 Hz |
| Kurzschlußprüfung Short - circuit test | | | 76,300 v 76,200 v 76,100 v | 6,220 A 6,230 A 6,150 A |
| | | | | 363,900 W 50 Hz |

Bemerkung / Notice:

Sarstedt, 16.07.2024 / PR

1 2 3 4 5 6 7 8

A

B

C

D

E

F

A

B

C

D

E

F

Main terminal diagram

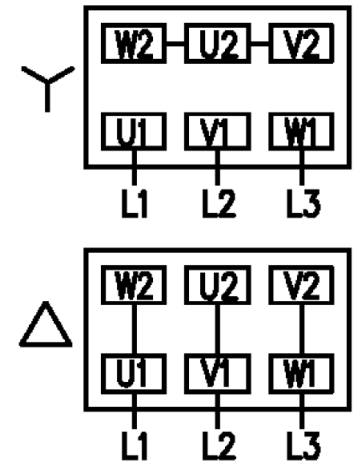
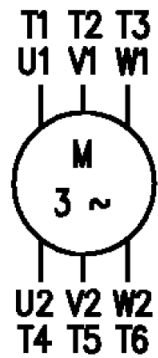

Motor protection

1/3x PTC thermistor disconnection

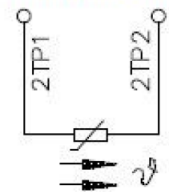

CONNECTION DIAGRAM

11000104291-92

| | | | | | | | | | |
|-------|--------------|--------------|---------|-----------|-------------------|---------|------------|----|------|
| D | | | | | | | | | |
| C | | | | | | | | | |
| B | | | | | | | | | |
| A | | | | | | | | | |
| Ind. | Modification | | | Date | Name | | | | |
| Scale | CAD | Construction | Cooling | Enclosure | Terminal conduct. | Drawn | 16.07.2024 | TB | Page |
| | | | | | | Approv. | 16.07.2024 | PR | |

1 2 3 4 5 6 7 8