



Toase-eh Park Sanati Gohar Ofogh
Petrochemical Co.
**CONCEPTUAL, BASIC and DETAIL DESIGN
ENGINEERING OF STYRENE PARK OFFSITE**



Document Title: NDT Procedure & Weld/NDT Map

Document No.: EI027-DMF-VD-QC-PRO-023

Rev. R3

Page 1 of 54

STYRENE PARK OFFSITE

Document Title:
NDT Procedure & Weld/NDT Map

R3	11-Mar.-2025	IFA	A. PARSAFAR	A. SHADMAND	M.Ahmadi
R2	10-Dec-2024	IFA	A. PARSAFAR	A. SHADMAND	M.HEIDARZADEH
R1	24-08-2024	IFA	A. PARSAFAR	A. SHADMAND	M.HEIDARZADEH
R0	20-08-2024	IFA	A. PARSAFAR	A. SHADMAND	M.HEIDARZADEH
Rev.	Issued Date	DESCRIPTION	PREPARED	CHECKED	APPROVED



**Toase-eh Park Sanati Gohar Ofogh
Petrochemical Co.
CONCEPTUAL, BASIC and DETAIL DESIGN
ENGINEERING OF STYRENE PARK OFFSITE**



Document Title: NDT Procedure & Weld/NDT Map





Document No.: EI027-DMF-VD-QC-PRO-023

Rev. R3

Page 2 of 54

REVISION RECORD SHEET





Page	Revisions							Page	Revisions						
	R0	R1	R2	R3	R4	R5	R6		R0	R1	R2	R3	R4	R5	R6
1	X	X	X	X				41	X	X					
2	X	X	X	X				42	X	X					
3	X	X						43	X	X					
4	X	X						44	X	X					
5	X	X						45	X	X					
6	X	X						46	X	X					
7	X	X						47	X	X					
8	X	X						48	X	X					
9	X	X						49	X	X					
10	X	X						50	X	X					
11	X	X						51	X	X					
12	X	X						52	X	X					
13	X	X						53		X	X	X			
14	X	X						54		X	X	X			
15	X	X						55							
16	X	X						56							
17	X	X						57							
18	X	X						58							
19	X	X						59							
20	X	X						60							
21	X	X						61							
22	X	X						62							
23	X	X						63							
24	X	X						64							
25	X	X						65							
26	X	X						66							
27	X	X						67							
28	X	X						68							
29	X	X						69							
30	X	X						70							
31	X	X						71							
32	X	X						72							
33	X	X						73							
34	X	X						74							
35	X	X						75							
36	X	X						76							
37	X	X						77							
38	X	X						78							
39	X	X		X				79							
40	X	X						80							

 	Toase-eh Park Sanati Gohar Ofogh Petrochemical Co. CONCEPTUAL, BASIC and DETAIL DESIGN ENGINEERING OF STYRENE PARK OFFSITE	 
	Document Title: NDT Procedure & Weld/NDT Map	
	Document No.: EI027-DMF-VD-QC-PRO-023	Rev. R3 Page 3 of 54

- 1.0 PURPOSE
- 2.0 SCOPE
- 3.0 REFERENCES
- 4.0 DEFINITION
- 5.0 SURFACE PREPARATION
- 6.0 DRYING AFTER PREPARATION
- 7.0 TECHNIQUES
- 8.0 CALIBRATION
- 9.0 EXAMINATION
- 10.0 INTERPRETATION
- 11.0 ACCEPTANCE CRITERIA
- 12.0 POST-EXAMINATION CLEANING
- 13.0 DOCUMENTATION
- 14.0 CERTIFICATION
- 15.0 PERSONNEL QUALIFICATION
- 16.0 Repair and re-examination of defective weld

RADIOGRAPHIC TEST





- 17.0 PURPOSE
- 18.0 SCOPE
- 19.0 REFERENCE
- 20.0 DEFINITION
- 21.0 GENERAL REQUIREMENTS
- 22.0 SURFACE PREPARATION
- 23.0 EQUIPMENT USED

 	Toase-eh Park Sanati Gohar Ofogh Petrochemical Co. CONCEPTUAL, BASIC and DETAIL DESIGN ENGINEERING OF STYRENE PARK OFFSITE	 
	Document Title: NDT Procedure & Weld/NDT Map	
	Document No.: EI027-DMF-VD-QC-PRO-023	Rev. R3 Page 4 of 54

- 24.0 RADIOGRAPHIC DENSITY
- 25.0 IDENTIFICATION OF RADIOGRAPHS
- 26.0 GEOMETRICAL UNSHARPNESS
- 27.0 FILM PROCESSING
- 28.0 RADIOGRAPHIC TECHNIQUE
- 29.0 INTERPRETATION OF RADIOGRAPHS
- 30.0 EVALUATION OF INDICATIONS
- 31.0 ACCEPTANCE CRITERIA
- 32.0 DEFECT REMOVAL
- 33.0 REPORTS
- 34.0 FILM STORAGE

ULTRASONIC TEST

- 35.0 PURPOSE
- 36.0 SCOPE
- 37.0 REFERENCES
- 38.0 DEFINITION
- 39.0 PERSONNEL QUALIFICATION
- 40.0 GENERAL REQUIREMENTS
- 41.0 EQUIPMENT USED
- 42.0 WELD EXAMINATION
- 43.0 Surface preparation
- 44.0 Examination
- 45.0 Evaluation
- 46.0 ACCEPTANCE CRITERIA
- 47.0 EXAMINATION REPORT (APPENDIX 1)

 	Toase-eh Park Sanati Gohar Ofogh Petrochemical Co. CONCEPTUAL, BASIC and DETAIL DESIGN ENGINEERING OF STYRENE PARK OFFSITE	 
	Document Title: NDT Procedure & Weld/NDT Map	
	Document No.: EI027-DMF-VD-QC-PRO-023	Rev. R3 Page 5 of 54

1.0. PURPOSE

This procedure defines the methods of performance, the examination conditions and the precautions to be taken when liquid penetrant examination is carried out of Air-cooled heat exchangers of “
Toase ehe Park Sanati Gohar Ofogh Petrochemical Co.
CONCEPTUAL, BASIC and DETAIL DESIGN ENGINEERING OF STYRENE PARK OFFSITE ”

2.0. SCOPE





This procedure is applicable for carry out testing on welded joints of header boxes of air-cooled heat exchanger and Materials, shapes, or sizes to be examined and the extent of examination are according to NDT. CHECK LIST & NDT MAP of project.

In principle, a liquid penetrant is applied to the surface to be examined and allowed to enter discontinuities. All excess penetrant is then removed, the part is dried, and a developer is applied. The developer function both as a blotter to absorb penetrant that has been trapped in discontinuities, and as a contrasting background to enhance the visibility of penetrant indications. The dyes in penetrants are either color contrast (visible under white light) or fluorescent (visible under ultraviolet light).

3.0. REFERENCES

- 3.1. ASME Sec.V- edition 2010
- 3.2. NDT. CHECK LIST & NDT MAP: EI027-DMF-VD-QC-PRO-023
- 3.3. ASME section VIII div.1 edition 2010 addendum 2011 shall be added
- 3.4 ASME B31.3
- 3.5 ASTM E165

4.0. DEFINITION

 	Toase-eh Park Sanati Gohar Ofogh Petrochemical Co. CONCEPTUAL, BASIC and DETAIL DESIGN ENGINEERING OF STYRENE PARK OFFSITE	 
	Document Title: NDT Procedure & Weld/NDT Map	
	Document No.: EI027-DMF-VD-QC-PRO-023	Rev. R3 Page 6 of 54

4.1. Relevant Indications:

Indications with major dimensions greater than 1/16 (1.5 mm)

4.2. Linear Indications:

An indication having a length greater than three times the width.

4.3. Rounded Indications

An indication of circular or elliptical shape with the length equal or less than three times the width.

5.0. SURFACE PREPARATION

5.1. In general, satisfactory results may be obtained when the surface of the part is in the as welded, as-rolled, as-cast, or as-forged condition. Surface preparation by grinding, machining,





Or other methods may be necessary where surface irregularities could mask indications.

5.2. Prior to each liquid penetrant examination, the surface to be examined and all adjacent areas within at least 1 in(25mm) shall be dry and free of all dirt, grease, lint, scale, welding flux, weld spatter, paint, oil, and other extraneous matter with using Hand tool cleaner like Brush.

Oil, paint, grease shall be cleaned with a solvent.

6.0. DRYING AFTER PREPARATION

After cleaning, drying of the surfaces to be examined shall be accomplished by normal evaporation or with forced hot or cold air. A minimum period of time shall be established to ensure that the cleaning solution has evaporated prior to application of the penetrant.

 	Toase-eh Park Sanati Gohar Ofogh Petrochemical Co. CONCEPTUAL, BASIC and DETAIL DESIGN ENGINEERING OF STYRENE PARK OFFSITE	  
	Document Title: NDT Procedure & Weld/NDT Map	
	Document No.: EI027-DMF-VD-QC-PRO-023	Rev. R3 Page 7 of 54

The surface of the part to be processed shall not be below 40°F (5°C) nor above 125°F(52°C). The air pressure shall not exceed 30psi (206KPa).

7.0. TECHNIQUES

7.1. Technique for Standard Temperature

As a standard technique, temperature of the penetrant and the surface of the part to be processed shall not be below 50°F (10°C) nor above 125°F (52°C) throughout the examination period. Local heating or cooling is permitted provided the part temperature remains in the range of 50°F to 125°F (10°C to 52°C) during the examination.

7.2. Techniques for Nonstandard Temperatures





When it is not practical to conduct a liquid penetrant examination within the temperature range of 40°F to 125°F (5°C to 52°C), the examination procedure at the proposed lower or higher temperature range requires qualification of the penetrant materials and processing in accordance with Mandatory Appendix III of this Article.

7.2. Technique Restriction

Fluorescent penetrant examination shall not follow a color contrast penetrant examination. Intermixing of penetrant materials from different families or different manufacturers is not permitted. A retest with water washable penetrants may cause loss of marginal indications due to contamination.

Either a color contrast (visible) penetrant or a fluorescent shall be used with water washable technique.

8.0. CALIBRATION

 	Toase-eh Park Sanati Gohar Ofogh Petrochemical Co. CONCEPTUAL, BASIC and DETAIL DESIGN ENGINEERING OF STYRENE PARK OFFSITE	 
	Document Title: NDT Procedure & Weld/NDT Map	
	Document No.: EI027-DMF-VD-QC-PRO-023	Rev. R3 Page 8 of 54

Light meters, both visible and fluorescence (black) light meters shall be calibrated at least once a year or whenever the meter has been repaired. If meters have not been in use for one year or more, calibration shall be done before being used.

9.0. EXAMINATION

9.1. Penetrant Application

The penetrant should be applied by spraying.

9.2. Penetration (Dwell) Time





Penetration (dwell) time is critical. The minimum penetration time shall be as required in following table (1) or as qualified by demonstration for specific applications.

9.3. Excess Penetrant Removal

After the specified penetration (dwell) time has elapsed, any penetrant remaining on the surface shall be removed, taking care to minimize removal of penetrant from discontinuities.

Excess penetrant shall be removed with a water spray. The water pressure shall not exceed 50 psi (350KPa) (According to ASME Sec V T-673.1), and the water temperature shall not exceed 110°F(43°C).

9.4. Fluorescent Penetrants.

 	Toase-eh Park Sanati Gohar Ofogh Petrochemical Co. CONCEPTUAL, BASIC and DETAIL DESIGN ENGINEERING OF STYRENE PARK OFFSITE	  
	Document Title: NDT Procedure & Weld/NDT Map	
	Document No.: EI027-DMF-VD-QC-PRO-023	Rev. R3 Page 9 of 54

With fluorescent penetrants, the process is essentially the same as in T-676.3, with the exception that the examination is performed using an ultraviolet light, called black light. The examination shall be performed as follows:

- (a) It shall be performed in a darkened area.
- (b) Examiners shall be in a darkened area for at least 5 min prior to performing examinations to enable their eyes to adapt to dark viewing. Glasses or lenses worn by examiners shall not be photosensitive.
- (c) Black lights shall achieve a minimum of 1000W/cm² on the surface of the part being examined throughout the examination.
- (d) Reflectors and filters should be checked and, if necessary, cleaned prior to use. Cracked or broken filters shall be replaced immediately.
- (e) The black light intensity shall be measured with a black light meter prior to use, whenever the light's power source is interrupted or changed, and at the completion of the examination or series of examinations.

9.5. Drying After Excess Penetrant Removal

For the water washable technique, the surface may be dried by blotting with clean materials or by using circulating air, provided the temperature of the surface is not raised above 125°F(52°C).

Material	Form	Type of Discontinuity	Minimum Dwell Times (minutes)	
			Penetrant	Developer
Steel	Welds	Cold shuts, Porosity, Lack of fusion, Cracks (all forms)	5	10





 	Toase-eh Park Sanati Gohar Ofogh Petrochemical Co. CONCEPTUAL, BASIC and DETAIL DESIGN ENGINEERING OF STYRENE PARK OFFSITE	 
	Document Title: NDT Procedure & Weld/NDT Map	
	Document No.: EI027-DMF-VD-QC-PRO-023	Rev. R3 Page 10 of 54

Table (1) Ref.: TABLE T-672- ASME SEC.V ARTIVLE 6

*Note1: For temperature range from 50°F to 125°F (10°C to 52°C)

9.6.1. For temperatures from 5°C to 10°C, minimum penetrant dwell time shall be 2 times the value listed.

9.7 Developing

9.7.1. The developer shall be applied as soon as possible after penetrant removal; the time interval shall not exceed that established in the procedure. Insufficient coating thickness may not draw the penetrant out of discontinuities conversely, excessive thickness may mask indications.

With color contrast penetrants, only a wet developer shall be used. With fluorescent penetrants, a wet or dry developer may be used.

9.7.2. Developing time for final interpretation begins immediately after the application of a dry developer or as soon as a wet developer coating is dry. The minimum developing time shall be as required by Table.1 and minimum 10 minutes.

9.7.3. Developer Application





The developer should be applied by spraying.

9.8. Minimum time periods between steps and drying aids is 10 minutes.

Maximum time periods between steps and drying aids is 30 minutes.

10.0. INTERPRETATION

Final interpretation shall be made within 10 to 60 min. after the requirement of procedure are satisfied. Using a 1000 lux light All relevant indications shall be recorded and evaluated as per ASME sec. VIII Div. 1.

 	Toase-che Park Sanati Gohar Ofogh Petrochemical Co. CONCEPTUAL, BASIC and DETAIL DESIGN ENGINEERING OF STYRENE PARK OFFSITE	 	
	Document Title: NDT Procedure & Weld/NDT Map		
	Document No.: EI027-DMF-VD-QC-PRO-023	Rev. R3	Page 11 of 54

11.0. ACCEPTANCE CRITERIA

Liquid penetrant techniques shall be judged unacceptable when the examination exhibits any indication in excess of the limits specified below :(According to ASME Sec. VIII Div.1 Appendix8):

- (I)-Any type of crack
- (II)- Relevant linear indication
- (III)-Relevant rounded indications greater than 3/16 in. (5mm)
- (IV)-Four or more relevant rounded indications in a line separated by 1/16 in (1.5 mm) or less (edge to edge).

12.0. POST-EXAMINATION CLEANING

When post-examination cleaning is required by the procedure, it should be conducted as soon as practical after evaluation.

After evaluation the remaining material to be removed by Proper solvent or water and clean cloth.

13.0. DOCUMENTATION

13.1. Recording of Indication

- (a) Non reject able Indication





Non rejectable indications shall be recorded as specified by the referencing Code Section.

- (b) Reject able Indications

Reject able indications shall be recorded. As a minimum, the type of indications (linear or rounded), location and extent (length or diameter or aligned) shall be recorded.

13.2. Examination Report

For each examination, the following information shall be recorded (As a minimum, the examination report shall include required information, described in article 6. ASME section V)

 	Toase-eh Park Sanati Gohar Ofogh Petrochemical Co. CONCEPTUAL, BASIC and DETAIL DESIGN ENGINEERING OF STYRENE PARK OFFSITE	 
	Document Title: NDT Procedure & Weld/NDT Map	
	Document No.: EI027-DMF-VD-QC-PRO-023	Rev. R3 Page 12 of 54

Procedure identification and revision

Liquid penetrant type (visible or fluorescence)

Type (number or letter designation) of each penetrant, penetrant remover, and developer used.

Examination personnel identify and, qualification level

Map or record of indications Per T-691 ASME SEC.V

Material and thickness

Lighting equipment

Date and time examination were performed.

The report shall be signed and dated by the qualified and certified level II/III.

Examination report shall be prepared and furnished to the client.

14. CERTIFICATION

After examination a liquid penetrant examination report shall be filled out, in accordance with requirements of part T.693 of ASME Code sec. V

15. PERSONNEL QUALIFICATION





Operators shall be qualified and certified in accordance with SNT-TC-1A.

All NDE shall be done by personnel certified to SNT-TC-1A level II /III.

15.1. Performance Demonstration

When be required is according to ASME SEC.V Article 14. T-1423

16. Repair and re-examination of defective weld

 	Toase-eh Park Sanati Gohar Ofogh Petrochemical Co. CONCEPTUAL, BASIC and DETAIL DESIGN ENGINEERING OF STYRENE PARK OFFSITE	 
	Document Title: NDT Procedure & Weld/NDT Map	
	Document No.: EI027-DMF-VD-QC-PRO-023	Rev. R3 Page 13 of 54

Any weld defects shall be fully chipped out, and the repair cavity shall be inspected by the liquid penetrant method. The repair welding shall be re-examined after the required heat treatment.

17.0. PURPOSE

This procedure describes the procedure for radiographic examination of welds of Air-cooled heat exchangers that will be procured in "Toase-eh Park Sanati Gohar Ofogh Petrochemical Co. CONCEPTUAL, BASIC and DETAIL DESIGN ENGINEERING OF STYRENE PARK OFFSITE"

18.0. SCOPE

This procedure is applicable for carry out testing on flange to pipe or obround butt welds of header boxes of air cooled heat exchanger and materials, shapes, or sizes to be examined and the extent of examination are according to NDT. CHECK LIST & NDT MAP of project .

19.0. REFERENCES

- 19.1. API-661-Edition 2006
- 19.2. ASME sec V-Edition 2010
- 19.3. ASNT-TC-1A-Edition 2006
- 19.4. ASME Section VIII Div.1 edition 2010 addendum 2011 shall be added.





20.0. DEFINITION

- 20.1. I.Q.I: Image Quality Indicator

21.0. GENERAL REQUIREMENTS

21.1. Particular instruction

The particular instruction shall refer to the general examination specification

 	Toase-eh Park Sanati Gohar Ofogh Petrochemical Co. CONCEPTUAL, BASIC and DETAIL DESIGN ENGINEERING OF STYRENE PARK OFFSITE	 
	Document Title: NDT Procedure & Weld/NDT Map	
	Document No.: EI027-DMF-VD-QC-PRO-023	Rev. R3

- The areas of the part to be examined,
- Materials and thickness ranges to be radiographed,
- Isotope used
- Film brand or type to be used,
- Screens to be used,
- Acceptance criteria.

21.2. Operator qualification

Operators shall be qualified and certified in accordance with SNT-TC-1A-Edition 2006 last applicable edition.

All NDE shall be done by or under the supervision of personnel certified to SNT- TC-1A-Edition 2006 level II/III.

22.0. SURFACE PREPARATION

22.1. Materials





Surfaces shall satisfy the requirements of the applicable material specifications, with additional conditions if necessary. In that case, surface irregularities shall be removed by any appropriate means so as not to mask indications or interfere with them.

22.2. Welds

The welds ripples or weld surface irregularities on both the inside (where accessible) and outside shall be removed by any suitable process to such a degree that the resulting radiographic image due to any irregularities cannot mask or be confused with the image of any discontinuity.

The finished surface of all butt-welded joints must be smoothly blended into the base material

within the limits specified in the referencing code section (ASME SEC.VIII-Edition 2012-U-35).

 	Toase-eh Park Sanati Gohar Ofogh Petrochemical Co. CONCEPTUAL, BASIC and DETAIL DESIGN ENGINEERING OF STYRENE PARK OFFSITE	 
	Document Title: NDT Procedure & Weld/NDT Map	
	Document No.: EI027-DMF-VD-QC-PRO-023	Rev. R3 Page 15 of 54

Permitted reinforcement on each face as following:

Material Nominal Thickness, mm	Maximum Reinforcement, mm.	
	Butt Welds	
Less than 2.4	2.4	
2.4 to 4.8, incl.	3.2	
Over 4.8 to 13, incl.	4.0	
Over 13 to 25, incl.	4.8	
Over 25 to 51, incl.	5	
Over 51 to 76, incl.	6	
Over 76 to 102, incl.	6	
Over 102 to 127, incl.	6	
Over 127	8	

23.0. EQUIPMENT USED

23.1. Film selection

Radiographs shall be made using industrial radiographic film ASTM type (***Very fine grain film must be use (KODAK MX125) with 10Cm width***).

23.2. Intensifying screens

Intensifying lead screens may be used except when otherwise specified. Good screen-film contact is essential to get a good result. Thickness of front & back screen: 0.1 mm

23.3. Back scatter protection





A back lead layer has to be used in order to:

- reduce the scattering of the radiations,
- avoid secondary back-scattered radiations

This back lead layer shall be placed on the back of each film holder / cassette.

A lead symbol "B" with dimensions of 13 mm (1/2 inch) in height, and 1, 6 mm (1/16 inch) in thickness has to be attached on the back of the film holder.

If a light image of the "B" appears on a darker background of the radiograph, protection from

 	Toase-eh Park Sanati Gohar Ofogh Petrochemical Co. CONCEPTUAL, BASIC and DETAIL DESIGN ENGINEERING OF STYRENE PARK OFFSITE	  
	Document Title: NDT Procedure & Weld/NDT Map	
	Document No.: EI027-DMF-VD-QC-PRO-023	Rev. R3 Page 16 of 54

backscatter is insufficient and the radiograph shall be considered unacceptable.

A dark image of the "B" on a lighter background is not cause for rejection.

Intensifying and back lead screens shall be perfectly clean, free from scratches, crimps, blemishes or folds.

23.4. Irradiation equipment

23.4.1. Radioactive sources

Generally, the minimum thickness for which radioactive sources may be used is as less thickness may be radiographed with these sources if it is demonstrated that the required sensitivity can be obtained.

The maximum thickness for the use of radioactive sources is primarily dictated by exposure time. Therefore upper limits are not shown.





Material	Minimum Thickness	
	Iridium 192	Cobalt 60
Steel	19 mm	38 mm
High Nickel Alloy	17 mm	33 mm

23.4.2. Special conditions

When an examination is performed, which strays from the conditions fixed above, or when other sources are used, a procedure for the particular examination must be issued.

In any case, the radiographic sensitivity depends essentially on:

- Film selection,
- Intensifying screen selection,
- Geometrical un sharpness,
- Film density.

 	Toase-eh Park Sanati Gohar Ofogh Petrochemical Co. CONCEPTUAL, BASIC and DETAIL DESIGN ENGINEERING OF STYRENE PARK OFFSITE	 
	Document Title: NDT Procedure & Weld/NDT Map	
	Document No.: EI027-DMF-VD-QC-PRO-023	Rev. R3 Page 17 of 54

23.5. Image quality indicators (Penetrometers)

23.5.1. Sensitivity of the radiographic technique (T 283)

The sensitivity of the radiographic technique shall be sufficient to display the penetrometer image and the specified wire of the penetrometer which are essential indications of the image quality of the radiograph. It shall also allow displaying the numbers and letters used to identify the films.

All radiographs shall show appropriate image quality indicators (penetrometers), in compliance with ASME codes. However the sensitivity shall not be lower than 2% of the thickness.

23.5.2. Selection of the penetrometers

23.5.2.1. Material

The penetrometers shall be made in a material with similar absorption coefficient to that of the material to be radiographed.

23.5.2.2. General dimensions of the penetrometers

The penetrometers shall be of the hole or wire type and its dimensions and geometry are given by the figures in 7.5.2.3.

Variations of length and /or width are accepted.

Other penetrometers may be used but require a special qualification and an agreement by contract.

23.5.2.3. Identification of the penetrometers(s)

The penetrometer shall be identified by lead numbers located in an appropriate area.



Toase-eh Park Sanati Gohar Ofogh
Petrochemical Co.
**CONCEPTUAL, BASIC and DETAIL DESIGN
ENGINEERING OF STYRENE PARK OFFSITE**



Document Title: NDT Procedure & Weld/NDT Map

Document No.: EI027-DMF-VD-QC-PRO-023

Rev. R3

Page 18 of 54

PENETRAMETERS WITH WIRE

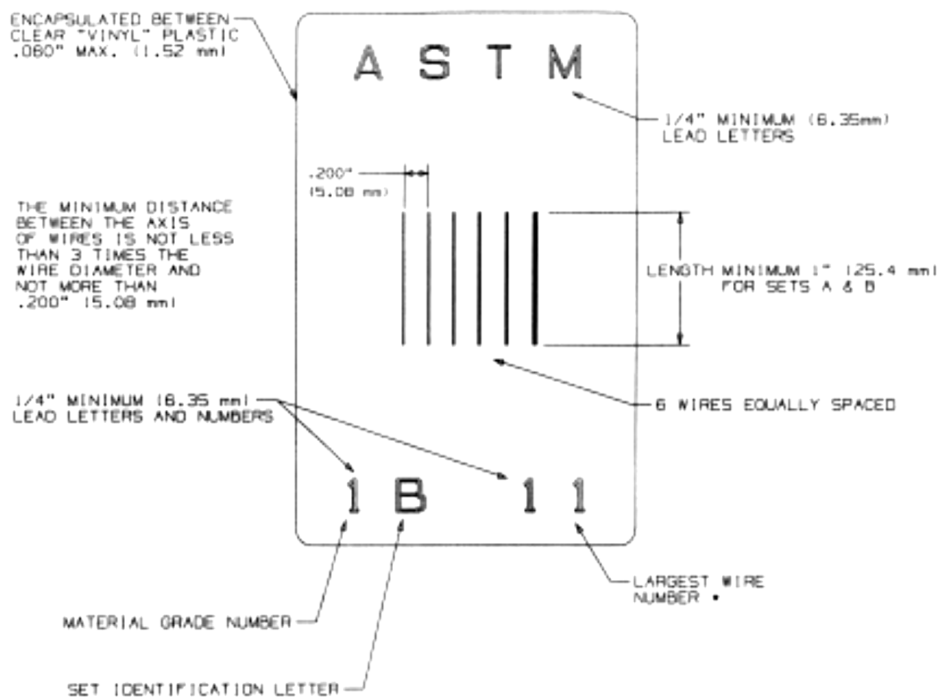

Design for wire type IQI (SETA&B)-Alternate 1(Fig. 3 SE 747 Art. 22 ASME Sec. V)



Toase-eh Park Sanati Gohar Ofogh
Petrochemical Co.
**CONCEPTUAL, BASIC and DETAIL DESIGN
ENGINEERING OF STYRENE PARK OFFSITE**



Document Title: NDT Procedure & Weld/NDT Map

Document No.: EI027-DMF-VD-QC-PRO-023

Rev. R3

Page 19 of 54

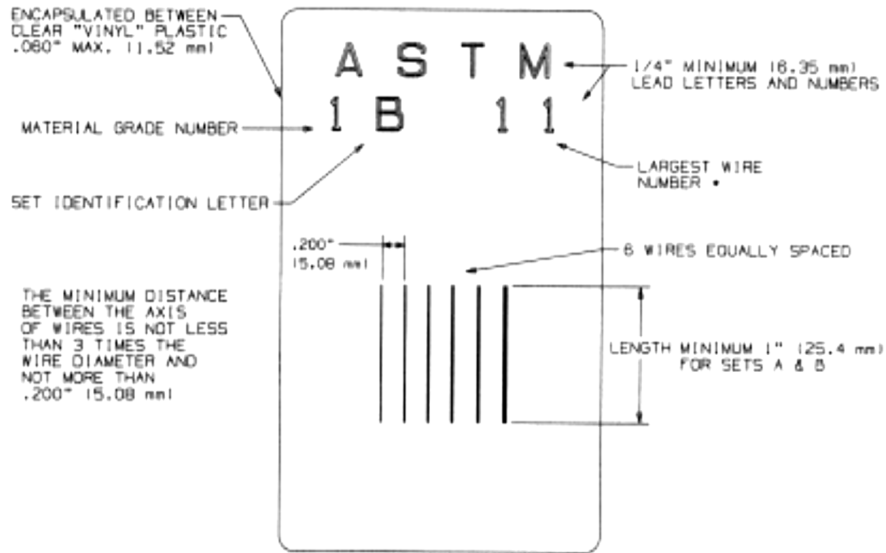

Design for wire type IQI (SETA&B)-Alternate 2(Fig. 4 SE 747 Art. 22 ASME Sec. V)

7.5.2.4. PENETRATOR DESIGNATION AND WIRE DIAMETERS

The following table shows the diameter of the wires of the different types of penetrators.



Toase-eh Park Sanati Gohar Ofogh
Petrochemical Co.
**CONCEPTUAL, BASIC and DETAIL DESIGN
ENGINEERING OF STYRENE PARK OFFSITE**



Document Title: NDT Procedure & Weld/NDT Map

Document No.: EI027-DMF-VD-QC-PRO-023

Rev. R3

Page 20 of 54

SET A		SET B	
Wire Diameter, in. (mm)	Wire Identity	Wire Diameter, in. (mm)	Wire Identity
0.0032 (0.08) ^A	1	0.010 (0.25)	6
0.004 (0.1)	2	0.013 (0.33)	7
0.005 (0.13)	3	0.016 (0.4)	8
0.0063 (0.16)	4	0.020 (0.51)	9
0.008 (0.2)	5	0.025 (0.64)	10
0.010 (0.25)	6	0.032 (0.81)	11
SET C		SET D	
Wire Diameter, in. (mm)	Wire Identity	Wire Diameter, in. (mm)	Wire Identity
0.032 (0.81)	11	0.10 (2.5)	16
0.040 (1.02)	12	0.126 (3.2)	17
0.050 (1.27)	13	0.160 (4.06)	18
0.063 (1.6)	14	0.20 (5.1)	19
0.080 (2.03)	15	0.25 (6.4)	20
0.100 (2.5)	16	0.32 (8)	21





**TABLE 3
WIRE DIAMETER TOLERANCES (in.)**

Wire Diameter (d), in	Tolerance, in
$0.000 < d \leq 0.005$	± 0.0001
$0.005 < d \leq 0.010$	± 0.0002
$0.010 < d \leq 0.020$	± 0.0004
$0.020 < d \leq 0.063$	± 0.0008
$0.063 < d \leq 0.160$	± 0.0012
$0.160 < d \leq 0.320$	± 0.0020

23.5.2.5. Selection of the penetrometer versus the thickness to be radio graphed

The tables on the next page give the selection elements of the penetrometer and the diameter of the characteristic hole or wire versus the thickness to be radio graphed.

23.5.2.5.1. Welds with reinforcements:

 	Toase-eh Park Sanati Gohar Ofogh Petrochemical Co. CONCEPTUAL, BASIC and DETAIL DESIGN ENGINEERING OF STYRENE PARK OFFSITE	  	
	Document Title: NDT Procedure & Weld/NDT Map		
	Document No.: EI027-DMF-VD-QC-PRO-023	Rev. R3	Page 21 of 54

The thickness on which the penetrometer is based is the nominal single wall thickness plus the estimated weld reinforcement not to exceed the maximum permitted (according to section 7.2). Backing rings or strips shall not be considered as part of the thickness in penetrometer selection. The actual measurement of the weld reinforcement is not required.

23.5.2.5.2. Welds without reinforcements:

The thickness on which the penetrometer is based is the nominal single wall thickness. Backing rings or strips shall not be considered as part of the weld thickness in penetrometer selection.

23.5.2.6. Placement of penetrometers (T 277.1)

The penetrometer(s) shall be placed on the weld so that the length of the wires is perpendicular to the length of the weld. The identification numbers and lead letter "F", when used, shall not be in the area of interest, except for the conditions described in the above mentioned two cases.

For the material other than welds, the penetrometer and its identification, as well as the letter "F" when used, shall be placed in the area of interest.

If for reasons of inaccessibility, it is impossible to place the penetrometer on the source side, it shall be placed on the film side on the part and a lead letter "F", at least as high as the identification number to the penetrometer, shall be placed adjacent to or on the penetrometer.



Toase-eh Park Sanati Gohar Ofogh
Petrochemical Co.
**CONCEPTUAL, BASIC and DETAIL DESIGN
ENGINEERING OF STYRENE PARK OFFSITE**



Document Title: NDT Procedure & Weld/NDT Map

Document No.: EI027-DMF-VD-QC-PRO-023

Rev. R3

Page 22 of 54

IQI

Nominal Single-Wall Material Thickness Range, in. (mm)	Source Side			Film Side		
	Hole-Type Designation	Essential Hole	Wire-Type Essential Wire	Hole-Type Designation	Essential Hole	Wire-Type Essential Wire
Up to 0.25, incl. (6.4)	12	2T	5	10	2T	4
Over 0.25 through 0.375 (6.4 through 9.5)	15	2T	6	12	2T	5
Over 0.375 through 0.50 (9.5 through 12.7)	17	2T	7	15	2T	6
Over 0.50 through 0.75 (12.7 through 19.0)	20	2T	8	17	2T	7
Over 0.75 through 1.00 (19.0 through 25.4)	25	2T	9	20	2T	8
Over 1.00 through 1.50 (25.4 through 38.1)	30	2T	10	25	2T	9
Over 1.50 through 2.00 (38.1 through 50.8)	35	2T	11	30	2T	10
Over 2.00 through 2.50 (50.8 through 63.5)	40	2T	12	35	2T	11
Over 2.50 through 4.00 (63.5 through 101.6)	50	2T	13	40	2T	12
Over 4.00 through 6.00 (101.6 through 152.4)	60	2T	14	50	2T	13
Over 6.00 through 8.00 (152.4 through 203.2)	80	2T	16	60	2T	14
Over 8.00 through 10.00 (203.2 through 254.0)	100	2T	17	80	2T	16
Over 10.00 through 12.00 (254.0 through 304.8)	120	2T	18	100	2T	17
Over 12.00 through 16.00 (304.8 through 406.4)	160	2T	20	120	2T	18
Over 16.00 through 20.00 (406.4 through 508.0)	200	2T	21	160	2T	20

Selection of the penetrometer





When the shape of the part or its dimensions do not allow to place the penetrometer(s) on the part, the penetrometer(s) may be placed on a separate block provided that the block:

- Is made of a material, radio graphically similar to the part,
- Has the same thickness as the part being radiographed,
- Is located as close as possible to the material being radiographed

The block dimensions shall exceed the penetrometer dimensions such that the outline of at least three sides of the penetrometer image shall be visible on the radiograph.

23.5.2.7. Number of penetrometers

a) For components where one or more film holders are used for an exposure, at least one penetrometer image shall appear on each radiograph. If the density of the radiograph anywhere through the area of interest varies by more than minus 15% or plus 30% from the density through the body of the penetrometer, within the minimum/maximum allowable density ranges specified in subparagraph 9.2, then an additional penetrometer shall be used for each

 	Toase-eh Park Sanati Gohar Ofogh Petrochemical Co. CONCEPTUAL, BASIC and DETAIL DESIGN ENGINEERING OF STYRENE PARK OFFSITE	 
	Document Title: NDT Procedure & Weld/NDT Map	
	Document No.: EI027-DMF-VD-QC-PRO-023	Rev. R3 Page 23 of 54

exceptional area or areas and the radiograph retaken. When calculating the allowable variation in density, the calculation may be rounded to the nearest 0.1.

b) If the requirements of 7.5.2.7.a) and 8.2. are met by using more than one penetrometers, one shall be representative of the lightest area of interest and the other the darkest area of interest ; in that case, the intervening densities on the radiograph shall be considered as acceptable.

24.0. RADIOGRAPHIC DENSITY

24.1. Equipment used (T 262)

The density of the radiographic film shall be verified by means of

- Either a densitometer,
- Or a step wedge comparison film

The densitometer (or the step wedge comparison film) shall be verified by means of a calibrated step wedge film traceable to a national standard. The densitometer will be calibrated according to PI 022.





24.2. Limitation of the radiographic density (T 282.1)

The transmitted film density through the radiographic image of the body of the appropriate penetrometer and the area of interest shall be:

- For single film technique = 2.0. Minimum for radiographs made with Gamma-ray sources,
- For composite viewing of multiple film exposures, each film of the composite set shall have a minimum density of 1.3.

The maximum density shall be 4 for either single or composite viewing.

A tolerance of 0.05 in density is allowed for variations between densitometer readings.

 	Toase-eh Park Sanati Gohar Ofogh Petrochemical Co. CONCEPTUAL, BASIC and DETAIL DESIGN ENGINEERING OF STYRENE PARK OFFSITE	  
	Document Title: NDT Procedure & Weld/NDT Map	
	Document No.: EI027-DMF-VD-QC-PRO-023	Rev. R3 Page 24 of 54

25.0. IDENTIFICATION OF RADIOGRAPHS

25.1. System of film identification (T 224)

A system shall be used to produce permanent identification on the radiograph traceable to the order number, the part, the weld or the weld seam or part numbers as appropriate.

In addition, the date of the radiograph shall be plainly and permanently included on the radiograph. This identification system does not necessarily required that the information appear as radiographic images.

In any case, this information shall not obscure the area of interest.

Code of part	Code Of Welder
Date of Test	DTT Project Number

Film location markers (T 275) .a





Location markers, which are to appear as radiographic images on the film, shall be placed on the part to be radiographed and not on the film holder / cassette.

Their locations shall be marked on the surface of the part being radiographed or on a map, in a manner permitting the area of interest on a radiograph to be accurately traceable to its location on the part for the required retention period of the radiograph, and provide evidence on the radiograph that the required coverage of the region being examined has been obtained.

26.0. GEOMETRICAL UNSHARPNESS (T 274)

26.1. Definition of geometrical unsharpness

The geometrical unsharpness is given by the equation:

 	Toase-eh Park Sanati Gohar Ofogh Petrochemical Co. CONCEPTUAL, BASIC and DETAIL DESIGN ENGINEERING OF STYRENE PARK OFFSITE		  
	Document Title: NDT Procedure & Weld/NDT Map		
	Document No.: EI027-DMF-VD-QC-PRO-023	Rev. R3	Page 25 of 54

$$U_g = \frac{F \cdot d}{D}$$

with :

- Ug (mm) is the geometrical unsharpness,
- F (mm) is the maximum projected dimension of the radiating source or focal spot in the plane perpendicular to the distance D from the weld or the part being radiographed,
- D (mm) is the distance from source of radiation to weld or other object being radiographed,
- d (mm) is the distance from source side of weld or object being radiographed to the film.

26.2. Limitations of the geometrical unsharpness (T 285)





In the case of Section VIII the limitations below are only to be taken as a guide, the quality of the radiograph being judged according to the possibility of discerning the characteristic wire of penetrometer.

Material thickness (mm)	Ug maximum (mm)
Under 50	0.510
50 through 75	0.760
Over 75 through 100	1.020
Greater than 100	1.780

Note: Material thickness is the thickness on which the penetrometer is based.

27.0. FILM PROCESSING

The conditions of manual processing procedure are as follows:

 	Toase-eh Park Sanati Gohar Ofogh Petrochemical Co. CONCEPTUAL, BASIC and DETAIL DESIGN ENGINEERING OF STYRENE PARK OFFSITE	  
	Document Title: NDT Procedure & Weld/NDT Map	
	Document No.: EI027-DMF-VD-QC-PRO-023	Rev. R3 Page 26 of 54

- a) **Developer:** temperature 20°C (68°F), time = 5 or 8 min (according to the type of film);
- b) **Rinsing:** stop bath = aqueous solution with 2% acetic acid, temperature 20°C (68°F), time = 1 min;
- c) **Fixing:** temperature 20°C (68°F), time = 8 min
- d) **Washing:** filtered water, room temperature, time = 10 min
- e) **Glazing:** wetting agent, room temperature, time = 2 or 3 min immersions
- f) **Drying:** Ambient temperature

28.0. RADIOGRAPHIC TECHNIQUE

A single-wall exposure technique shall be used for radiography whenever practical. When it is not practical to use a single-wall technique, a double-wall technique shall be used.

28.1. Single-wall technique

In the single-wall technique, the radiation passes through only one wall of the weld (material), which is viewed for acceptance on the radiograph. An adequate number of exposures shall be made to demonstrate that the required coverage.

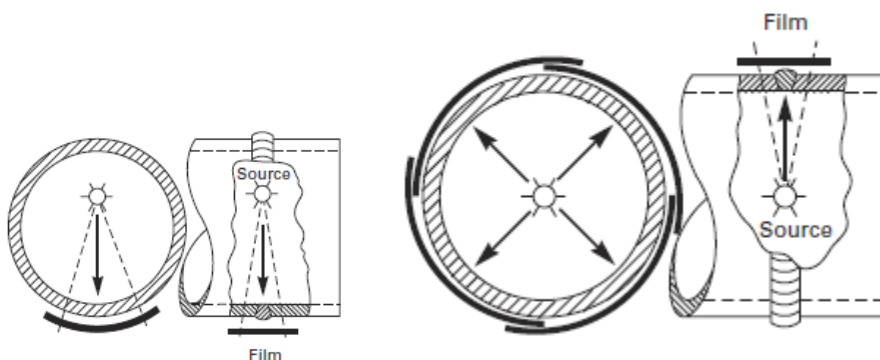



Toase-eh Park Sanati Gohar Ofogh
Petrochemical Co.
**CONCEPTUAL, BASIC and DETAIL DESIGN
ENGINEERING OF STYRENE PARK OFFSITE**



Document Title: NDT Procedure & Weld/NDT Map

Document No.: EI027-DMF-VD-QC-PRO-023

Rev. R3

Page 27 of 54

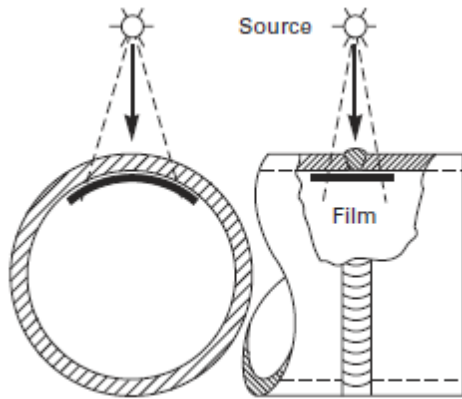

Exposure Arrangement — C

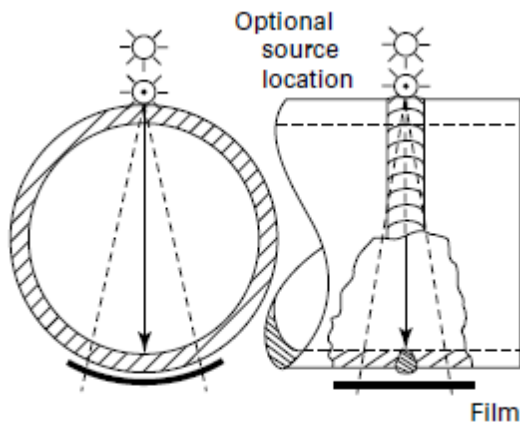



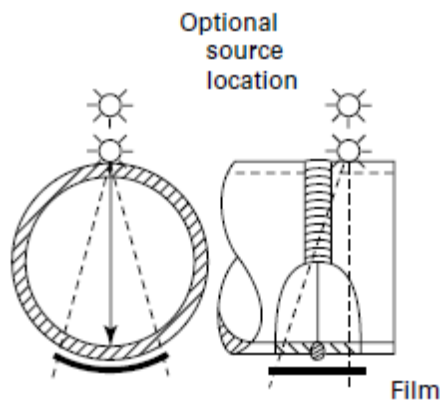

Exposure arrangement — D



Exposure arrangement — E

SINGLE-WALL RADIOGRAPHIC TECHNIQUES (According to Fig.A-210-1 ASME SEC.V-Ed.2010)

 	Toase-eh Park Sanati Gohar Ofogh Petrochemical Co. CONCEPTUAL, BASIC and DETAIL DESIGN ENGINEERING OF STYRENE PARK OFFSITE	 	
	Document Title: NDT Procedure & Weld/NDT Map		
	Document No.: EI027-DMF-VD-QC-PRO-023	Rev. R3	Page 28 of 54

28.2. Double -wall technique

12.2.1. For circumferential welds 4 in. (100 mm) outside diameter (3.5 in. nominal pipe size) or less, use a technique in which the radiation passes through both walls and both walls are viewed for acceptance on the same image. Unless otherwise specified, either elliptical or superimposed projections may be used. A sufficient number of views should be taken to examine the entire weld. Where design or access restricts a practical technique from examining the entire weld, agreement between contracting parties must specify necessary weld coverage.

12.2.2. For circumferential welds greater than 4 in.(100 mm) outside diameter (3.5 in. nominal pipe size), use a technique in which only single-wall viewing is performed.

A sufficient number of views should be taken to examine the entire weld. Where design or access restricts a practical technique from examining the entire weld, agreement between contracting parties must specify necessary weld coverage.



Toase-eh Park Sanati Gohar Ofogh
Petrochemical Co.
**CONCEPTUAL, BASIC and DETAIL DESIGN
ENGINEERING OF STYRENE PARK OFFSITE**



Document Title: NDT Procedure & Weld/NDT Map

Document No.: EI027-DMF-VD-QC-PRO-023

Rev. R3

Page 29 of 54

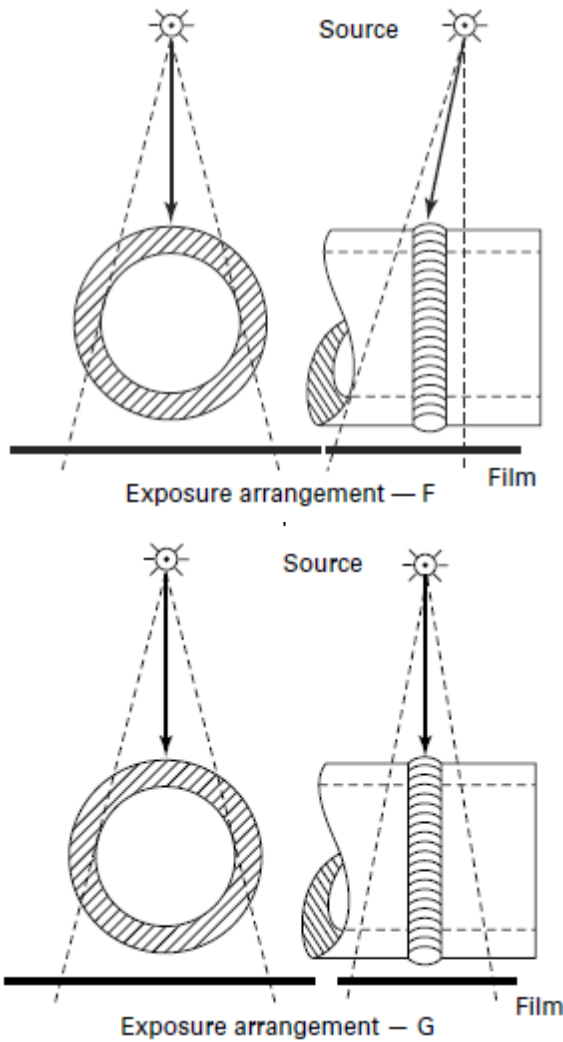





DOUBLE-WALL RADIOGRAPHIC TECHNIQUES (According to Fig.A-210-1 ASME SEC.V-Ed.2010)

29.0. INTERPRETATION OF RADIOGRAPHS

29.1. Prior to being presented to the Inspector for acceptance, the radiographs shall be examined and interpreted by the Manufacturer as complying with the referencing Code Section. The Manufacturer shall record the interpretation of each radiograph and disposition of the material examined on a radiographic interpretation review form accompanying the radiographs

29.2. Viewing facilities shall provide background lighting of an intensity that will not cause troublesome reflections, shadows, or glare on the radiograph. Equipment used to view radiographs for interpretation shall provide a variable light source sufficient

 	Toase-eh Park Sanati Gohar Ofogh Petrochemical Co. CONCEPTUAL, BASIC and DETAIL DESIGN ENGINEERING OF STYRENE PARK OFFSITE	  
	Document Title: NDT Procedure & Weld/NDT Map	
	Document No.: EI027-DMF-VD-QC-PRO-023	Rev. R3 Page 30 of 54

for the essential penetrometer hole or designate wire to be visible for the specified density range. The viewing conditions shall be such that light from around the outer edge of the radiograph or coming through low-density portions of the radiograph does not interfere with interpretation.

29.3. The nightscope used shall allow the interpretation of films with 4.0 density.

29.4. The films shall be free from any processing defects, scratches or any other blemishes that could interfere with the interpretation.

13.5. Films shall be interpreted dry.

30.0. EVALUATION OF INDICATIONS

The evaluation of indications shall be made in terms of the acceptance criteria given in the applicable ASME Code Section and the particular specifications.

30.1. Questionable indications

Any questionable indication shall be considered as a defect, unless a re-examination using the same examination method or any other suitable non-destructive examination method can demonstrate that such a questionable indication is not a defect.

31.0. ACCEPTANCE CRITERIA





31.1. Terminology

a) Linear Indication:

Cracks, incomplete fusion, inadequate penetration, and slag are represented on the radiograph as linear indication in which the length is more than three times the width.

B) Rounded Indication:

Porosity and inclusions such as slag or tungsten are represented on the radiograph as rounded indication with a length three times the width or less.

	Toase-eh Park Sanati Gohar Ofogh Petrochemical Co. CONCEPTUAL, BASIC and DETAIL DESIGN ENGINEERING OF STYRENE PARK OFFSITE		  	
	Document Title: NDT Procedure & Weld/NDT Map			
	Document No.: EI027-DMF-VD-QC-PRO-023		Rev. R3	Page 31 of 54

These indications may be circular, elliptical, or irregular in shape; may have tails; and may vary in density.

C) Aligned Indications:

A sequence of four or more rounded indications shall be considered to be aligned when they touch a line parallel to the length of the weld drawn through the centre of the two outer rounded indications.

D) Thickness

The thickness of the weld excluding any allowable reinforcement. For a butt weld joining two members having different thicknesses at the weld, t is the thinner of these two thicknesses.

31.2. Acceptance Criteria:

The following discontinuities are considered unacceptable (According to ASME Sec.VIII- Div.1-UW-51-Ed.2010).

(I)Linear Indications:





I.1) any type of crack or zone of incomplete fusion or penetration.

I.2) any elongated slag inclusion which has a length greater than:

a. 6 mm for t up to 19mm

b. $\frac{1}{3} t$ for t over 19mm to 57mm

c. 19 mm for t over 57mm

	Toase-eh Park Sanati Gohar Ofogh Petrochemical Co. CONCEPTUAL, BASIC and DETAIL DESIGN ENGINEERING OF STYRENE PARK OFFSITE		  	
	Document Title: NDT Procedure & Weld/NDT Map			
	Document No.: EI027-DMF-VD-QC-PRO-023	Rev. R3	Page 32 of 54	

I.3) any group of aligned inclusions that have an aggregate length greater than t in a length $12t$, except when the distance between the successive imperfections exceeds $6L$ where L is the length of the longest imperfection in the group.

(II) Rounded Indications (According to ASME SEC.VIII Div.1-APP.4-ED.2010)

II.a) Relevant indications

Only those rounded indications which exceed the following dimensions shall be considered relevant.

II.a.1) $1/10t$ for t less than 3mm

II.a.2) 0.4mm for t from 3mm to 6 mm, incl.

II.a.3) 0.8mm for t greater than 3mm to 50mm, incl.

II.a.4) 1.6mm for t greater than 50mm





II.b) Maximum size of rounded indication

The maximum permissible size of any indication shall be $1/4t$, or 4mm, whichever is smaller; except that an isolated indication separated from an adjacent indication by 25mm or more may be $1/3t$ or 6mm, whichever is less. For t greater than 50mm the maximum permissible size of an isolated indication shall be increased to 10mm.

II.c) Aligned rounded indications

Aligned rounded indications are acceptable when the summation of the diameters of the indications is less than t in a length of $12t$. (See fig 15.1.1). The length of groups of aligned rounded indications

and the spacing between the groups shall meet the requirements of Fig.51.2

 	Toase-eh Park Sanati Gohar Ofogh Petrochemical Co. CONCEPTUAL, BASIC and DETAIL DESIGN ENGINEERING OF STYRENE PARK OFFSITE	 
	Document Title: NDT Procedure & Weld/NDT Map	
	Document No.: EI027-DMF-VD-QC-PRO-023	Rev. R3

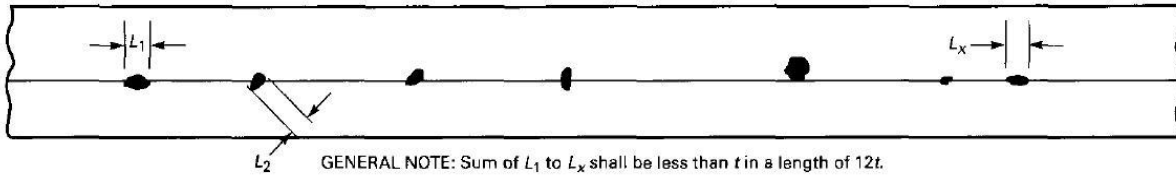
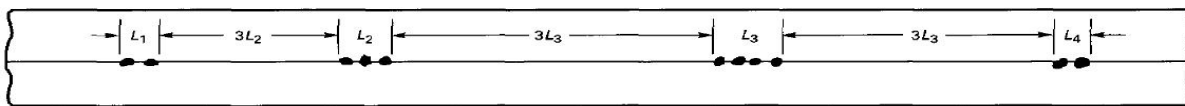

Fig.15.1.1. Aligned rounded indications



GENERAL NOTE: Sum of the group lengths shall be less than t in a length of $12t$.

<p>Maximum Group Length $L = 1/4$ in. (6 mm) for t less than $3/4$ in. (19 mm) $L = 1/3t$ for t $3/4$ in. (19 mm) to $2 1/4$ in. (57 mm) $L = 3/4$ in. (19 mm) for t greater than $2 1/4$ in. (57 mm)</p>	<p>Minimum Group Spacing $3L$ where L is the length of the longest adjacent group being evaluated.</p>
---	--

Fig.15.1.2. Groups of aligned rounded indications

II.d) Spacing

The distance between adjacent rounded indications is not a factor in determining acceptance or rejection, except as required for isolated indications or groups of aligned indications.

II.e) Rounded Indication Charts:

The rounded indications characterized as imperfections shall not exceed that shown in the charts.

The charts in Figs.15.1.3 through 15.1.8 illustrate various types of assorted, randomly dispersed and clustered rounded indications for different weld thicknesses greater than $1/8$ in (3mm). These charts represent the maximum acceptable concentration limits for rounded indications. The charts for each thickness range represent full-scale

6 in.(150mm) radiographs, and shall not be enlarged or reduced. The distributions shown are not necessarily the patterns that may appear on the radiograph, but are typical of the concentration and size of indications permitted.

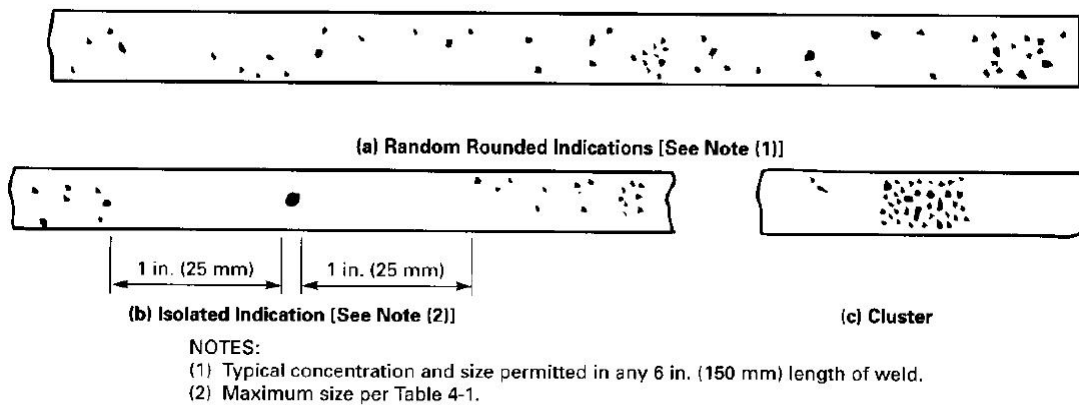

Fig.15.1.3. Charts for t equal to $1/8$ in. to $1/4$ in (3 to 6 mm) inclusive

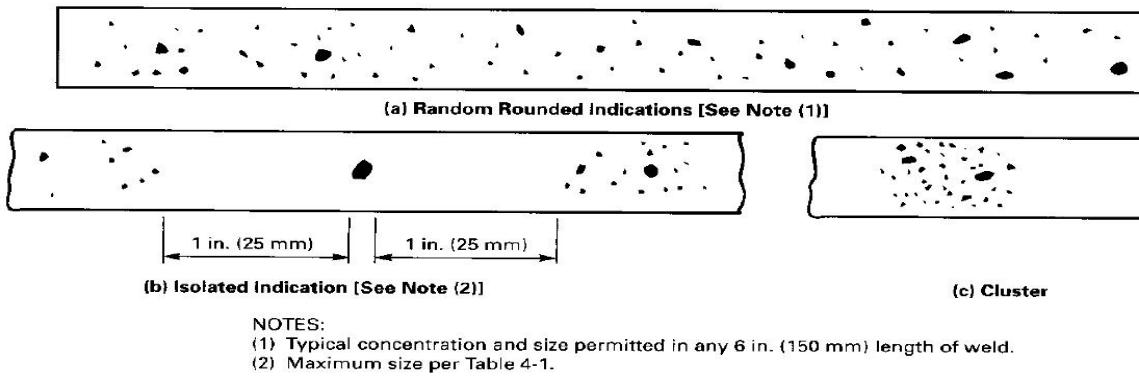

Fig. 15. 1. 4 . Charts for t equal to over $1/4$ in. to $3/8$ in. (6 to 10 mm) inclusive

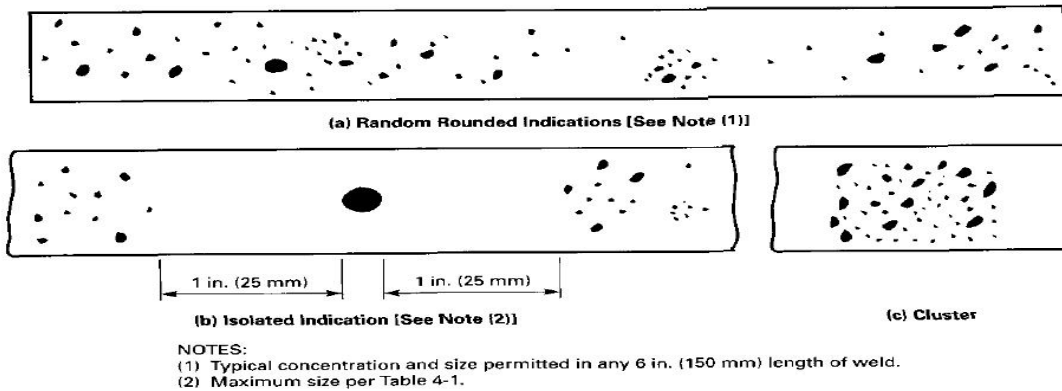

Fig. 15. 1. 5 Charts for t equal to over $3/8$ in. to $3/4$ in. (10 to 19 mm) inclusive

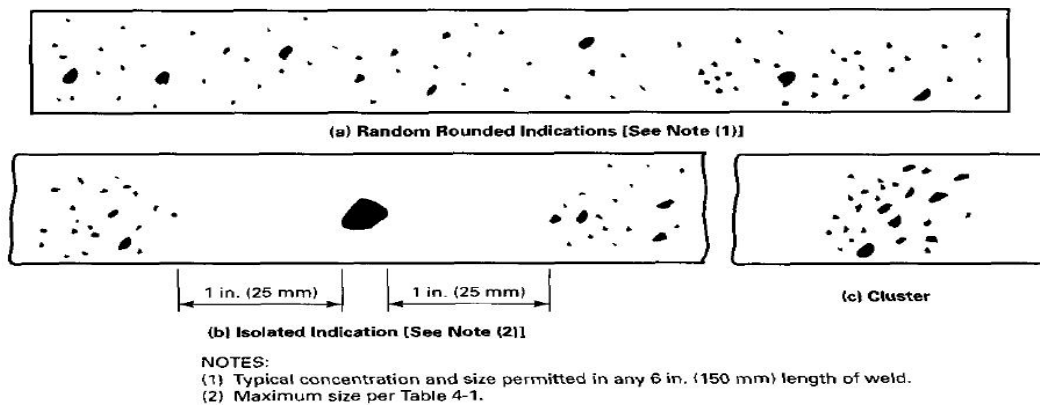

Fig. 15. 1. 6. Charts for t equal to over $3/4$ in. to 2 in. (19 to 50 mm) inclusive

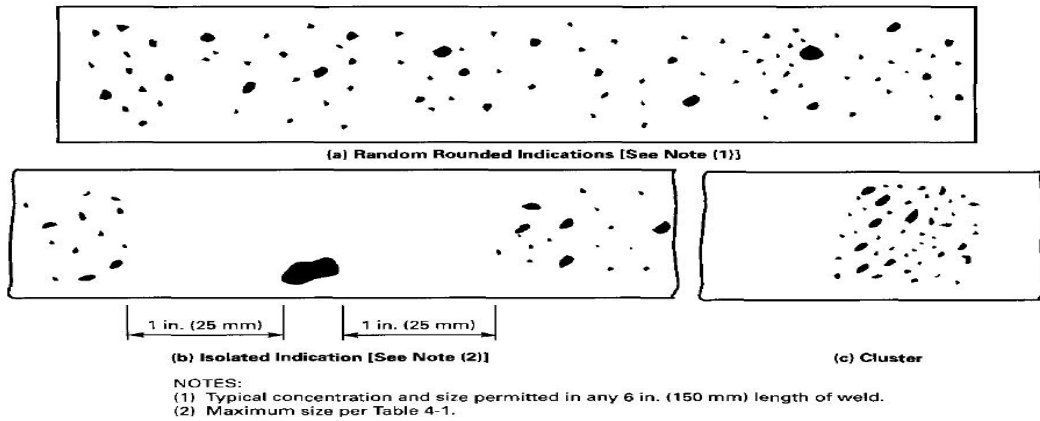

Fig. 15. 1. 7. Charts for t equal to over 2 in. to 4 in. (50 to 100 mm)

inclusive

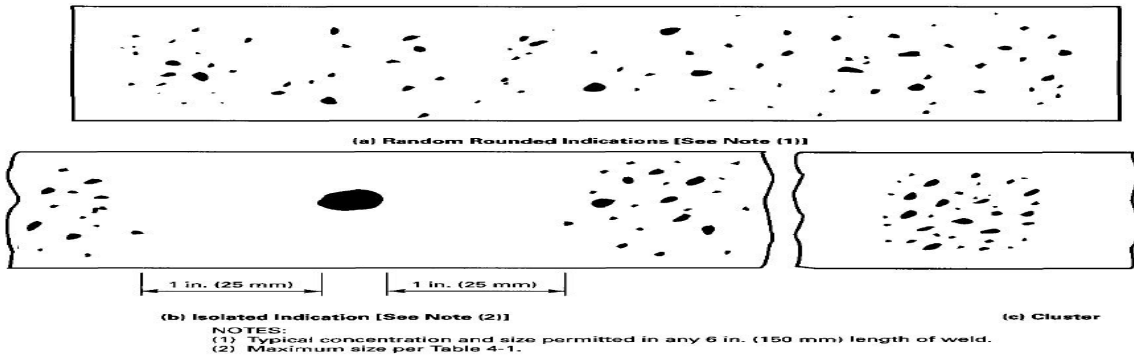







Fig. 15. 1. 8. Charts for t over 4 in. to 4 in. (100 mm) inclusive

II.f) Weld Thickness t less than 1/8 in(3mm)

For t less than 1/8 in.(3mm) the maximum number of rounded indications shall not exceed 12 in 6 in.(150mm) length of weld. A proportionally fewer number of indications shall be permitted in welds less than 6 in. (150mm) in length.

 	Toase-eh Park Sanati Gohar Ofogh Petrochemical Co. CONCEPTUAL, BASIC and DETAIL DESIGN ENGINEERING OF STYRENE PARK OFFSITE	  
	Document Title: NDT Procedure & Weld/NDT Map	
	Document No.: EI027-DMF-VD-QC-PRO-023	Rev. R3

II.g) Clustered indications

The illustrations for clustered indications show up to four times as many indications in a local area, as that shown in the illustrations for random indications. The length of an acceptable cluster shall not exceed the lesser of 1 in. (25mm) or 2t. Where more than one cluster is present, the sum of the lengths of the clusters shall not exceed 1in.(25mm) in a 6 in.(150mm) length weld.

32. DEFECT REMOVAL

16.1. All discontinuities in excess to acceptance standard shall be removed suitable means and repaired according to approved procedure.





16.2. The repaired area shall be radio graphed after repair accordance with this specification; the repeated film shall be identified with lead letter "R".

Thickness t , mm	Maximum Size of Acceptable Rounded Indication, mm		Maximum Size of Nonrelevant Indication, mm
	Random	Isolated	
Less than 3	$\frac{3}{4}t$	$\frac{1}{2}t$	$\frac{1}{10}t$
3	0.79	1.07	0.38
5	1.19	1.60	0.38
6	1.60	2.11	0.38
8	1.98	2.64	0.79
10	2.31	3.18	0.79
11	2.77	3.71	0.79
13	3.18	4.27	0.79
14	3.61	4.78	0.79
16	3.96	5.33	0.79
17	3.96	5.84	0.79
19.0 to 50, incl.	3.96	6.35	0.79
Over 50	3.96	9.53	1.60

NOTE:

(1) This Table contains examples only.

Table 16.1: Maximum Size Of Acceptable Rounded Indication (mm)

 	Toase-eh Park Sanati Gohar Ofogh Petrochemical Co. CONCEPTUAL, BASIC and DETAIL DESIGN ENGINEERING OF STYRENE PARK OFFSITE	 
	Document Title: NDT Procedure & Weld/NDT Map	
	Document No.: EI027-DMF-VD-QC-PRO-023	Rev. R3 Page 38 of 54

33. REPORTS

Any radiographic examination shall be documented in a report made using the form shown in the Appendix 1.

This report shall include the following minimum information:

- Identification, job number,
- Isotope
- Material type and thickness range,
- Minimum source to film distances,
- Film brand and designation,
- Number of films per cassette,
- Single -or double-wall exposure,
- Single -or double-wall viewing.

The report shall be prepared and dated by the qualified and certified Level II who examined the evaluation and disposition of the radiographs and approved by the qualified and certified Level II or Level III who performed the final acceptance of the radiographs.





A report shall be prepared and furnished to the client. Report of Radiographic Examination will be used.

34-FILM STORAGE:

Exposed films shall be stored in accordance with ASME SEC V article2 Appendix3

35.0. PURPOSE

This procedure defines the methods of performance, the examination conditions and the precautions to be taken when an ultrasonic examination is carried out of Air

 	Toase-ehe Park Sanati Gohar Ofogh Petrochemical Co. CONCEPTUAL, BASIC and DETAIL DESIGN ENGINEERING OF STYRENE PARK OFFSITE	  
	Document Title: NDT Procedure & Weld/NDT Map	
	Document No.: EI027-DMF-VD-QC-PRO-023	Rev. R3 Page 39 of 54

cooled heat exchangers that will be procured in "Toase-ehe Park Sanati Gohar Ofogh Petrochemical Co. CONCEPTUAL, BASIC and DETAIL DESIGN ENGINEERING OF STYRENE PARK OFFSITE "

36.0. SCOPE AND APPLICABLE PARTS FOR TEST

This procedure is applicable for carry out testing on welded joints of header boxes of air cooled heat exchanger and materials, shapes, or sizes to be examined and the extent of examination are according to NDT. CHECK LIST & NDT MAP of project (EI027-DMF-VD-QC-PRO-023).

37.0. REFERENCES

37.1. ASME SEC.VIII DIV.1, (2019)

37.2. ASME SEC.V-Last Edition

37.3 ANSI/ASME B31.3

38.0. DEFINITION

38.1. S.D.H Block: Side Drilled Hole block

38.2. D.A.C: Distance -Amplitude Correction

39.0. PERSONNEL QUALIFICATION

Operators shall be qualified and certified in accordance with SNT-TC-1A





All NDE shall be done by or under the supervision of personnel certified to SNT-TC-1A level II /III.

40.0. GENERAL REQUIREMENTS

40.1. Particular specifications

Each particular specification shall include at least the following information:

- Type of the material and/or of the weld to be examined including dimensions, thickness and shape of the product,
- Surface(s) from which the ultrasonic examination is to be carried out,
- surface finish,
- Couplant to be used
- examination technique: straight beam, angle beam, contact and/or immersion,

 	Toase-che Park Sanati Gohar Ofogh Petrochemical Co. CONCEPTUAL, BASIC and DETAIL DESIGN ENGINEERING OF STYRENE PARK OFFSITE	  
	Document Title: NDT Procedure & Weld/NDT Map	
	Document No.: EI027-DMF-VD-QC-PRO-023	Rev. R3 Page 40 of 54

- calibration description calibration blocks and calibration technique,
- directions and extent of scanning,
- information mentioned on examination report and recording method (manual or mechanized)
- Automatic alarm or recording equipment or both,
- Scanning mechanism; rotation, revolving, etc.
- Post-examination cleaning.

40.2. General examination requirements

40. 2.1. To assure a complete coverage of the whole area to be examined, each pass of the search unit shall overlap a minimum of 10% of the search unit width.

40.2.2. The rate of the search unit movement shall not exceed 150 mm / s.

41.0. EQUIPMENT USED

41.1. Frequency

Unless otherwise required in the particular examination specifications, the examination shall be conducted with pulse echo ultrasonic equipment capable of generating frequencies over the range of 1 to 5 MHz

41.2. Screen Height





Linearity

The ultrasonic instrument shall provide linear vertical presentation within $\pm 5\%$ of the full screen height for 20 % to 80 % of the calibrated screen height. The evaluation of the screen height linearity shall be performed before each period of extended use or at least every three months.

41.3. Amplitude Control

Linearity

The ultrasonic instrument shall use an amplitude control accurate over its useful range to $\pm 20\%$ of the nominal amplitude ratio. The evaluation of the amplitude control linearity shall be performed before each period of extended use or at least every three months. (Accordance to ASME Sec.V Art.4)

 	Toase-eh Park Sanati Gohar Ofogh Petrochemical Co. CONCEPTUAL, BASIC and DETAIL DESIGN ENGINEERING OF STYRENE PARK OFFSITE	 
	Document Title: NDT Procedure & Weld/NDT Map	
	Document No.: EI027-DMF-VD-QC-PRO-023	Rev. R3 Page 41 of 54

41.4. Equipment calibration

The adequate calibration shall be carried out before and after each examination .when there is a change in operator and when bad functioning is suspected.

When bad functioning is established during calibration, all examinations carried out after the last valid calibration shall be reconducted.

41.5. Search

Units

Search Units may contain either single or dual transducer elements.

42.0. WELD EXAMINATION

42.1. Calibration

- a) V1 & V2 Standard Test block.
- b) ASME Reference block (Side drilled hole $\phi=1.5$)
- c) The Material of Calibration shall be same P-No with base material

42.1.1. Calibration block for circular weld examination

For examination in materials where the examination surface diameter is greater than 500 mm (20in), a flat calibration block shall be used.

Otherwise the calibration block to be used shall be such as to calibrate examination on surfaces in the range of curvature from 0.9 to 1.5 times the calibration block diameter.





42.2. Technique

42.2.1. Angle beam calibration

The calibration shall include the following measurements:

- a) Sweep range calibration on block V1
- b) Distance- amplitude correction,
- c) Position calibration (given directly by numeric equipment),
- d) Echo amplitude measurement

The examination sensitivity shall be established at 80% of full screen height using the side drilled hole predicting the largest response. The distance amplitude correction (DAC) curve shall be constructed by utilizing the responses from the side drilled whole reflectors in the calibration block.

 	Toase-eh Park Sanati Gohar Ofogh Petrochemical Co. CONCEPTUAL, BASIC and DETAIL DESIGN ENGINEERING OF STYRENE PARK OFFSITE	  
	Document Title: NDT Procedure & Weld/NDT Map	
	Document No.: EI027-DMF-VD-QC-PRO-023	Rev. R3 Page 42 of 54

42.2.2. Straight beam calibration

The calibration shall include the following measurements:

- sweep range calibration on block V1
- Distance – amplitude correction
- echo amplitude measurement

Base metal:

The examination sensitivity shall be established at 75% of full screen height using the second back wall echo of the thickness examined.

Weld:

The examination sensitivity shall be established at 80% of full screen height using the side drilled hole predicting the largest response.

42.2.3. Non-Piping Calibration Block

42.2.3.1. Basic Calibration Block

The basic calibration block configuration and reflectors shall be as shown in next page .The block size and reflector locations shall be to perform calibrations for the beam angles used.

42.2.3.2. Block Thickness

When two or more base material are involved, the calibration block thickness shall be determined by the average thickness of the weld. Alternatively, a calibration block having the greater base material thickness may be used provided the reference reflector size is based upon the average or smaller weld thickness.

42.2.3.3. Block Range of Use

When the block thickness ± 1 in (25mm) spans two weld thickness ranges as shown in Fig. 1, the block's use shall be acceptable in those portions of each thickness. As an example, a calibration block with a thickness of 1½in. (38mm) could be used for weld thicknesses of 0.5 in (13mm) to 2.5in (64mm)

42.2.3.4. TECHNIQUES FOR STRAIGHT BEAM CALIBRATIONS (Distance–Amplitude Correction

The following is used for calibration (see Fig.2)

- (a) Position the search unit for the maximum indication from the SDH, which gives the highest indication.
- (b) Adjust the sensitivity (gain) control to provide an 80% ($\pm 5\%$) of FSH indication. This

is the primary reference

Level. Mark the peak of this indication on the screen.

(c) Position the search unit for maximum indication from another SDH.

(d) Mark the peak of the indication on the screen.



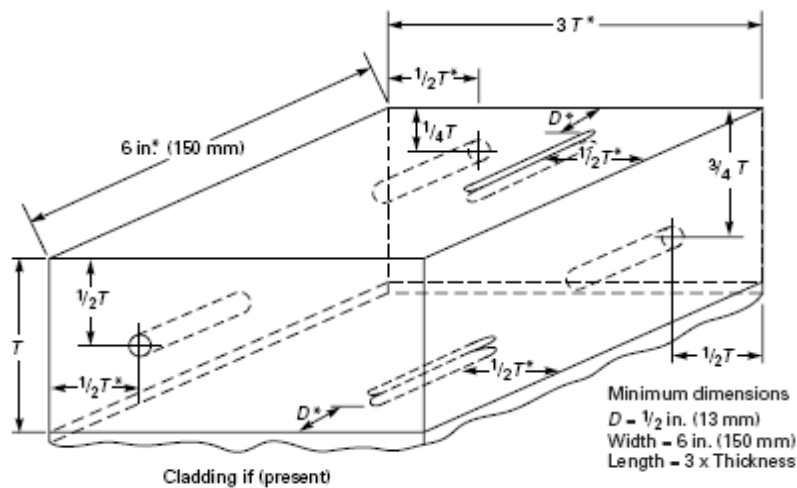

(e) Position the search unit for maximum indication from the third SDH and mark the peak on the screen.

(f) Connect the screen marks for the SDHs and extend through the thickness to provide the distance–amplitude curve.



Weld Thickness (t), in. (mm)	Calibration Block Thickness (T), in. (mm)	Hole Diameter, in. (mm)	Notch Dimensions, in. (mm)
Up to 1 (25)	$3/4 (19)$ or t	$3/32 (2.5)$	Notch depth = $2\% T$
Over 1 (25) through 2 (50)	$1 1/2 (38)$ or t	$1/4 (3)$	Notch width = $1/4 (6)$ max.
Over 2 (50) through 4 (100)	$3 (75)$ or t	$3/16 (5)$	Notch length = $1 (25)$ min.
Over 4 (100)	$t \pm 1 (25)$	[Note (1)]	

Figure 1. Non-Piping Calibration Block

 	Toase-eh Park Sanati Gohar Ofogh Petrochemical Co. CONCEPTUAL, BASIC and DETAIL DESIGN ENGINEERING OF STYRENE PARK OFFSITE	 
	Document Title: NDT Procedure & Weld/NDT Map	
	Document No.: EI027-DMF-VD-QC-PRO-023	Rev. R3 Page 44 of 54

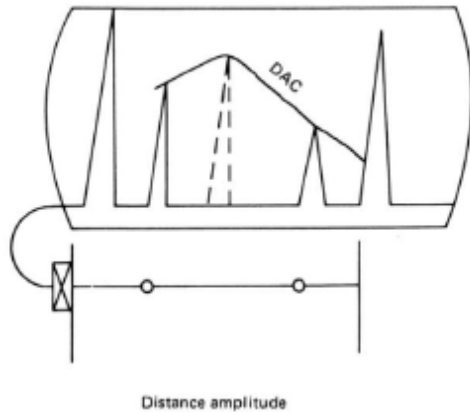

Figure 2. Distance–Amplitude Correction

42.2.4. Calibration for Piping

42.2.4.1. Calibration Block(s).

Calibrations shall be performed utilizing the calibration block shown in Fig. T-434.3.

42.2.4.2. Angle Beam Calibration.





The angle beam shall be directed toward the calibration reflector that yields the maximum response. The gain control shall be set so that this response is $80\% \pm 5\%$ of full screen height. This shall be the primary reference level. The search unit shall then be manipulated, without changing instrument settings, to obtain the maximum responses from the calibration reflectors at the distance increments necessary to generate a three-point distance-amplitude correction (DAC) curve.

Separate calibrations shall be established for both the axial and circumferential notches. These calibrations shall establish both the distance range calibration and the distance amplitude correction.

Straight Beam Calibration. When required, straight beam calibrations shall be performed to the requirements of Nonmandatory Appendix C using the side-drilled whole alternate calibration reflectors of T-434.1.1. This calibration shall establish both the distance range calibration and the distance amplitude correction.

System Calibration for Non-Distance Amplitude Techniques. Calibration includes all those actions required to assure that the sensitivity and accuracy of the signal amplitude and time outputs of the examination system (whether displayed, recorded, or automatically processed)

are repeated from examination to examination. Calibration may be by use of basic calibration blocks with artificial or discontinuity reflectors. Methods are provided in Nonmandatory Appendices B and C. Other methods of calibration may include

 	Toase-eh Park Sanati Gohar Ofogh Petrochemical Co. CONCEPTUAL, BASIC and DETAIL DESIGN ENGINEERING OF STYRENE PARK OFFSITE	  
	Document Title: NDT Procedure & Weld/NDT Map	
	Document No.: EI027-DMF-VD-QC-PRO-023	Rev. R3 Page 45 of 54

sensitivity adjustment based on the examination material, etc.

FIG. T-434.3 CALIBRATION BLOCK FOR PIPE

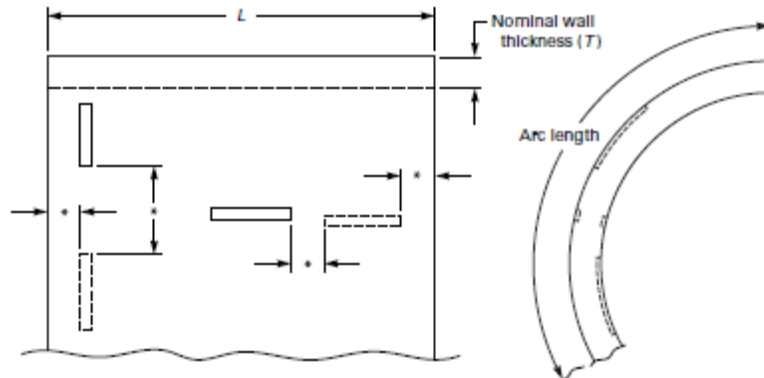

42.3. Calibration control

Calibration control shall be carried out each time the calibration block is to be used. This control shall concern the sweeping speed and the distance amplitude curve.

A calibration control of at least one reflector of the calibration block shall be carried out at the end of each examination of series of similar tests, or every four hours or when there is a change in operator.

42.3.1. Sweep range correction





If a point of the DAC curve has moved on the sweep line more than 10 % of the sweep reading or 5 % of full sweep-whichever is greater correct the sweep range calibration and note the correction on the examination record.

If reflectors are recorded on the data sheets, a new calibration shall be recorded. All recorded indications since the last valid calibration or calibration check shall be reexamined with the corrected calibration and their values shall be changed on the data sheets.

42.3.2. DAC correction

If a point of the Distance -Amplitude Correction (DAC) curve has decreased 20 % or 2dB of its amplitude, all data sheets since the last valid calibration or calibration check shall be marked void. A new calibration shall be made and recorded and the area covered by the voided data shall be re-examined.

If any point of the DAC curve has increased more than 20 % or 2 dB of its amplitude, all recorded indications since the last valid calibration or calibration check shall be re-examined with the corrected calibration and their values shall be changed on the data sheets.

 	Toase-eh Park Sanati Gohar Ofogh Petrochemical Co. CONCEPTUAL, BASIC and DETAIL DESIGN ENGINEERING OF STYRENE PARK OFFSITE	  
	Document Title: NDT Procedure & Weld/NDT Map	
	Document No.: EI027-DMF-VD-QC-PRO-023	Rev. R3 Page 46 of 54

43. Surface preparation

43.1. Base Metal

The contact surfaces shall be free from weld spatter or any roughness which would interfere with the free movement of the search unit or impair the transmission of the ultrasonic waves in the part.

44.0. Examination

44. 1. Straight beam scanning

For weld examination using angle beam search unit, the volume of the adjacent base metal to be crossed by the ultrasonic waves shall be scanned with a straight beam search unit so as to detect reflectors that might affect the interpretation of angle beam results.

This precaution is not to be considered as an acceptance-rejection examination. Locations and areas of such reflectors shall be recorded.

The weld and base metal scanning shall be performed at a gain setting two times (at least) the primary reference level Evaluation shall be performed with respect to the primary reference level. Evaluation shall be performed with respect to the primary reference level.

44. 2 .Angle beam scanning for detecting reflectors oriented parallel to the weld

The angle beam shall be directed at approximate right angles to the weld axis from two directions where possible.





The search unit shall be manipulated laterally and longitudinally so that the ultrasonic waves pass through the weld and the adjacent base metal.

The scanning shall be performed at a gain setting two times (at least) the primary reference level. Evaluation shall be performed with respect to the primary reference level.

44.3. Angle beam scanning for detecting reflectors transverse to the weld

The angle beam shall be essentially directed parallel to the weld axis. The search unit shall be manipulated so that the ultrasonic waves pass through the whole weld and the base metal adjacent to it.

The scanning shall be performed at a gain setting two times the primary reference level. Evaluation shall be performed with respect to the primary reference level. The search unit shall be rotated in two directions 180 ° and the examination repeated.

 	Toase-eh Park Sanati Gohar Ofogh Petrochemical Co. CONCEPTUAL, BASIC and DETAIL DESIGN ENGINEERING OF STYRENE PARK OFFSITE	 
	Document Title: NDT Procedure & Weld/NDT Map	
	Document No.: EI027-DMF-VD-QC-PRO-023	Rev. R3

44.4. Ultrasonic System

Calibrations shall include the complete ultrasonic system and shall be performed prior to using

The system in the thickness range under examination.

44.5. Calibration Surface

Calibrations shall be performed from the surface (clad or unclad; convex or concave) corresponding to the surface of the component from which the examination will be performed.

44.6. Couplant

The same couplant to be used during the examination shall be used for calibration.

44.7. Contact Wedges

The same contact wedges to be used during the examination shall be used for calibration.

44.8. Instrument Controls

Any control which affects instrument linearity (e.g., filters, reject, or clipping) shall be in the same position for calibration, calibration checks, instrument linearity checks, and examination.





44.9. Temperature

For contact examination, the temperature difference between the calibration block and examination surfaces shall be within 25 %.

45.0. Evaluation

All indications producing a response greater than 20% of the reference level shall be investigated so as to evaluate the shape, identify and location of the reflectors in accordance with the acceptance criteria defined in Chapter 13.

46.0. ACCEPTANCE CRITERIA

 	Toase-eh Park Sanati Gohar Ofogh Petrochemical Co. CONCEPTUAL, BASIC and DETAIL DESIGN ENGINEERING OF STYRENE PARK OFFSITE	  
	Document Title: NDT Procedure & Weld/NDT Map	
	Document No.: EI027-DMF-VD-QC-PRO-023	Rev. R3 Page 48 of 54

a) The discontinuities are unacceptable if their amplitude exceeds the reference level and their length the following dimensions (Accordance to ASME SEC VIII Appendix 12):

- 6 mm for $t \leq 19$ mm
- $1/3 t$ for $19 < t \leq 57$ mm
- 19 mm for $t > 57$ mm

* t = thickness to be examined

b) When discontinuities are interpreted to be cracks, lack of fusion or incomplete penetration, they are considered as unacceptable whatever their amplitude.

Repairs shall be re-examined according to this procedure.

47.0. EXAMINATION REPORT

The Examination Report (see Appendix 1) shall be generated, filed during five (5) years at least and shall contain the following information:

- all references, procedures and equipment used for examination so that the examination may be reconducted later on in the same conditions;
- reference of the conditions of equipment calibration;
- a sketch or drawing indicating the examined weld and the item / piece number;
- a record of repaired surfaces and results of the new examination; the report shall specify the location, the amplitude, the dimensions and the depth of the discontinuities below the surface and the classification.



Liquid Penetrant Test Report



CONTRACTOR:	PROJECT:	Request No.:
CLIENT:	Job No.:	Report No:
Vendor: Damafin	Member Number: As fallow	Date Of Test:
Standard: ASME SEC V & VIII	Dye Penetrant Mat. Spec.:	Test Temp.:
Drying: Natural Lighting:	Trade name:	Test Method:
Penetration Time:	Cleaner:	Excess Pent. Removal:
Development Time:	Penetrant:	Post cleaning Method:
Surface Preparation:	Developer:	Precleaning Method:

No	Exam Zone	Exam Length (mm)	Interpretation					Repairs		Stage Of Examination
			Defect. L(mm)	Type	Welder ID	Acc	Rej.	Acc.	Rej.	
1										
2										
3										
4										
5										
6										
7										

Weld Location And Identification Sketch :

L.C : Longitudinal Crack T.C : Transverse Crack C.C : Crater Crack P.H : Pin Hole
 U : Undercut L.O.F : Lack of Fusion S : Slag S.P : Surface Porosity
 SR : Spatter

DTT.	Purchaser	TPA	Owner / MC
Name :			
Level :			
Sign :			
Date :			



Radiography



Test Report



CONTRACTOR:	PROJECT:	Request No. :
CLIENT:	Job No. :	Report No : RT-DAM/
Vendor: Damafin	Member & ITEM Number :	Date Of Test :

Sub Vendor: DTT	Equipment :	Exposure Technique :
Material :	Source Type :	Film Type :
Code/Standard :	Source Size (mm) :	Screen Type & Thk. :
Version :	Activity (Ci) :	Acc.Density Range :
Procedure No. :	Voltage (KV) : ----	Acc.Sensitivity :
Version :	IQI :	Max. Acc. UG :





No	Weld Location	Weld No.	Film Length(cm)	Thk (mm)	SFD /FFD (cm)	Film Location	L / O.D.	Welder ID	Type of Defect	Judgment				Remark
										Acc	Rep	RS	RR	
1														
2														
3														
4														
5														



SKETCH:

Total of film :

Radiography Technique		Type of Defect		LF	Lack of Fusion	LC	Longitudinal Crack
SWSI	Single Wall- Single Image	SP	Spherical Porosity	CL	Cold Lap	TC	Transverse Crack
DWSI	Double Wall- Single Image	CP	Cluster Porosity	LP	Lack of Penetration	CC	Crater Crack
Elip.	Elliptical	WH	Worm Hole	RC	Root Concavity	SC	Shrinkage Cavity
Pano.	Panoramic	HB	Hollow Bead	S I	Slag Inclusion	RU	Root Undercut
Simp.	Super Impose	EP	Excess Penetration	SL	Slag Line	CU	Cap Undercut
L : Weld Length (cm)		BT	Burn Through	TI	Tangstan Inclusion	FM	Film Mark
O.D. : Outer Diameter (in)		Judgment		Acc.: Accept	Rep. Repair	RS : Re Shoot	RR : Re Radiography

DTT.	Purchaser	TPA	Owner / MC
Name :			
Date :			
Sign :			
Level :			

 		Ultrasonic Examination Report	  
CONTRACTOR:	PROJECT:	Request No. :	
CLIENT:	Job No. :	Report No : UT-DAM/	
Vendor: Damafin	Member Number:	Date Of Test :	
Equipment Maker :	Search Unit Maker :	Code/Standard :	
Model :	Type :	Procedure No. & Rev.:	
Serial No. :	Frequency : MHZ Size :	Calibration Data:	
Material :	Colibration Block :	Equipment Function :	
Thickness :	Base Material :	Screen Height Linearity :	
Surface Condition :	Couplant :	Amplitude Control Linearity :	
Weld No. & WPS No.:	Calibration sheet identify :	Sensitivity:	
Standard Sensitivity From SDH FBH Notch	Test Subject : Base Metal Weld Metal Casting		
Other :	Welding Process :		
Size : 1.5 mm	Groove Type :		
Examination Method :			
Contact Immersion		Pulse-Echo Through	
		Straight Beam	
		Transmission	
		Angle Beam 70 60 45 (Deg)	
Calibration Method :			
		S	SP SPD
Sensitivity Evaluation Method :			
		RL	RH DAC DGS

<p>OWNER</p> 	<p>Toase-ehe Park Sanati Gohar Ofogh Petrochemical Co. CONCEPTUAL, BASIC and DETAIL DESIGN ENGINEERING OF STYRENE PARK OFFSITE</p>	
<p>Project Document Number:</p>	<p>Document Title: NDT Map (All Items) EI027-DMF-VD-QC-PRO-023</p>	<p>REV. 03 Page 53 of 54</p>

NDT TABLE

Joint No:	Discription	Thk	WPS No:	Matrial 1	Matrial 2	PWHT	IMPACT	NDT Befor PWHT	NDT AFTER PWHT
1	TOP & BOTTOM PLATE TO TUBE SHEET/PLUG SHEET	20 TO 20	DS11-W010/01	SA516 Gr.70N	SA516 Gr.70N	100%	Yes	UT 100% PT 100%	UT 100% PT 100%
2	PARTITION OR STIFFENER TO TUBE SHEET & PLUG SHEET	12 TO 20	DS11-W010/02	SA516 Gr.70N	SA516 Gr.70N	100%	Yes	N/A	N/A
3	END PLATE TO TUBE & PLUG SHEET AND TOP & BOTTOM PLATE	20 TO 20	DS11-W011/01	SA516 Gr.70N	SA516 Gr.70N	100%	Yes	UT 100% PT 100%	UT 100% PT 100%
4	OBROUND/ PIPE NOZZLE TO FLANGE	13.49 TO 13.49	DS11-W012/01	SA333 Gr.6	SA 350 LF2CL.1N	100%	N/A	RT 100% PT 100%	RT 100% PT 100%
5	OBROUND / PIPE NOZZLE TO TOP PLATE	13.49 TO 20	<u>DS11-W012/02</u>	SA333 Gr.6	SA516 Gr.70N	100%	Yes	UT 100% PT 100%	UT 100% PT 100%
6	LWN FLANGE TO TOP & BOTTOM PLATE	14.3 & 16.6 TO 20	<u>DS11-W012/03</u>	SA 350LF2 CL.1N	SA516 Gr.70N	100%	N/A	UT 100% PT 100%	UT 100% PT 100%
7	NAME PLATE BRACKET AND OTHER ACCESSORIES TO HEADER	5 TO 20	<u>DS11-W014/01</u>	SA283 (St37)	SA516 Gr.70N	100%	N/A	PT 100%	PT 100%
8	TUBE SHEET TO TUBE	1.65 TO 20	<u>DS11-W025/01</u>	SA334 GR.6	SA516 Gr.70N	N/A	N/A	PT 100%	N/A
01	STRUCTURE - ALL GROOVE JOINT	3 TO 25	<u>WT-108</u>	S235JR (SA283-B)	S235JR (SA283-B)	N/A	N/A	N/A	N/A
02	STRUCTURE- ALL FILLET WELD	3 TO 25	<u>WT-111</u>	S235JR (SA283-B)	S235JR (SA283-B)	N/A	N/A	N/A	N/A

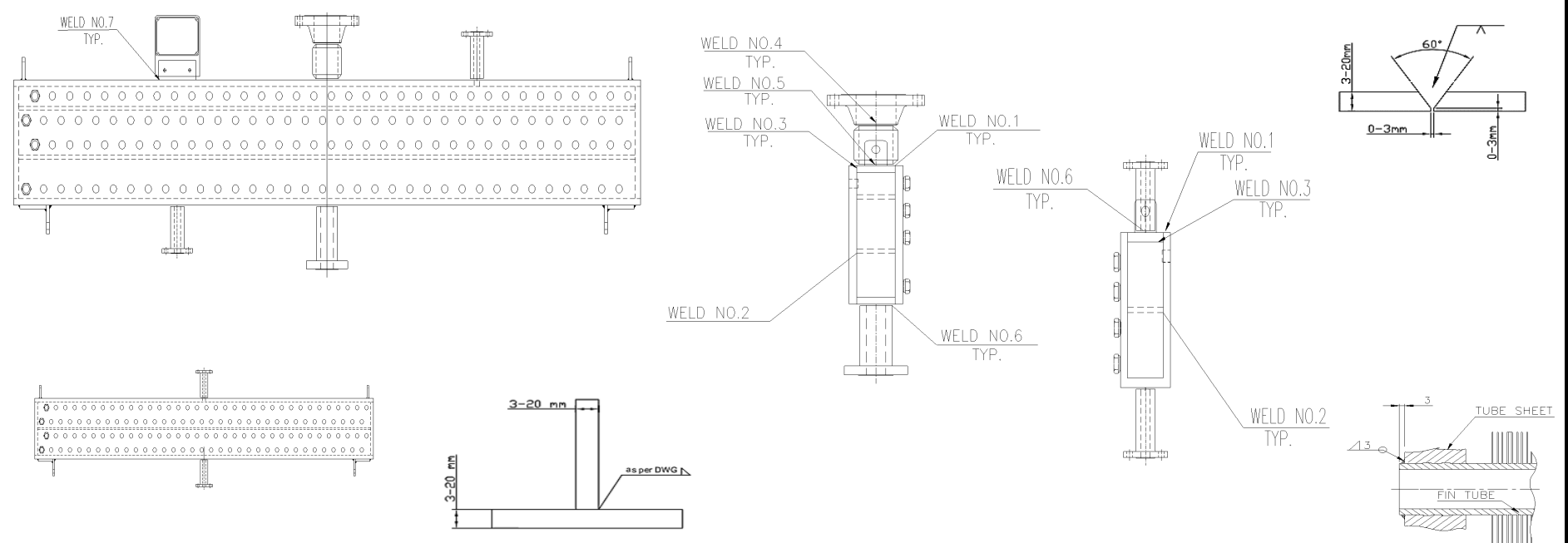

NOTES:

- 1) Visual check should be applied For Internal, External, Pressure Parts, NON Perssure Parts And any Applied Weldings.
- 2) 100% of the length should be ultrasonic tested .
- 3) Regarding Header box geometry , RT examination can be used only for flange to nozzle weld .
- 4) Spot radiographic or ultrasonic examinations shall include each start and stop of weld made by the automatic submerged arc-welding process and repaired areas of burn-through.

OWNER



Toase-eh Park Sanati Gohar Ofogh Petrochemical Co. CONCEPTUAL, BASIC and DETAIL DESIGN ENGINEERING OF STYRENE PARK OFFSITE



Document Title: NDT Map (All Items)

REV. : 03

Page : 54 OF 54

Project Document Number:

EI027-DMF-VD-QC-PRO-023

1

TOP & BOTTOM PLATE TO TUBE SHEET & PLUG SHEET

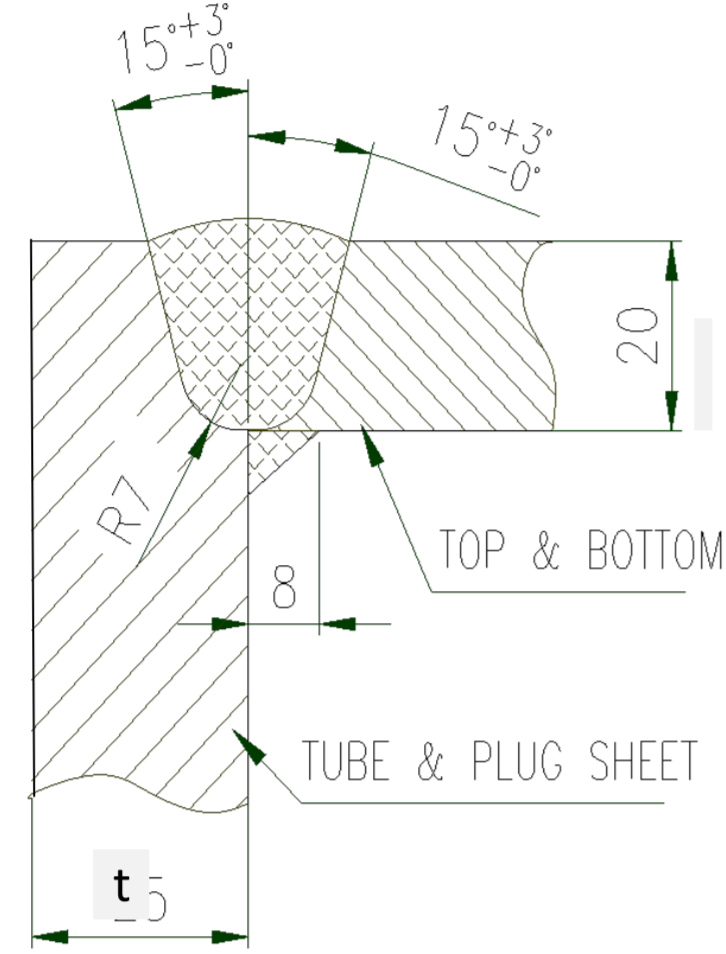

2

PARTITION OR STIFFENER TO TUBE SHEET & PLUG SHEET

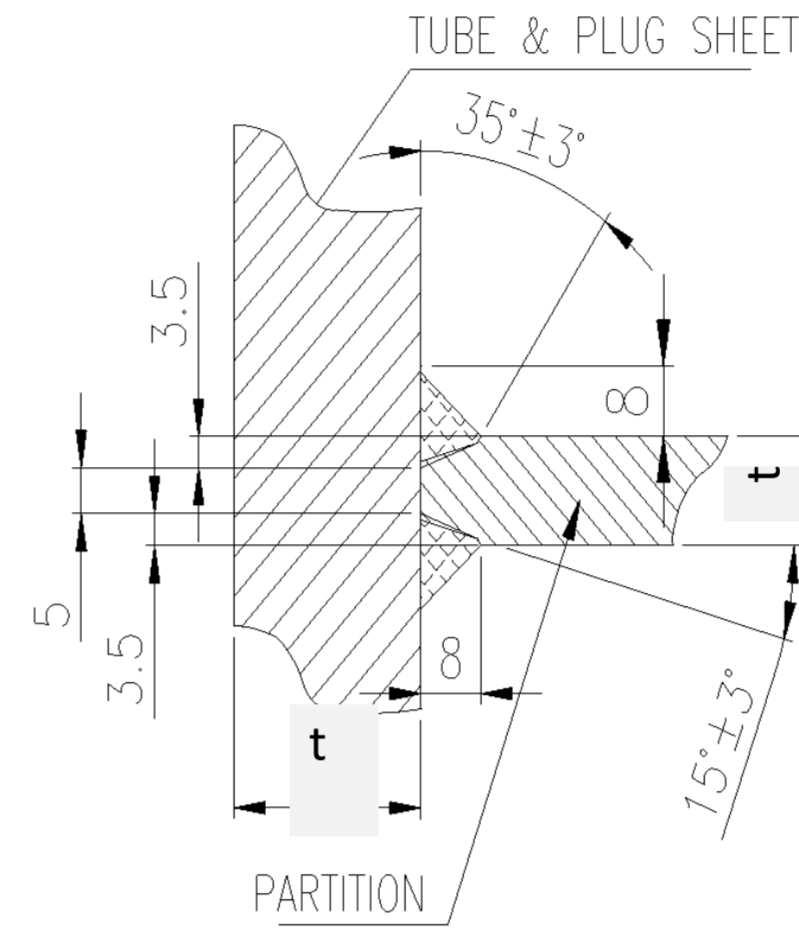

3

END PLATE TO TUBE SHEET AND PLUG SHEET & TOP AND BOTTOM PLATE

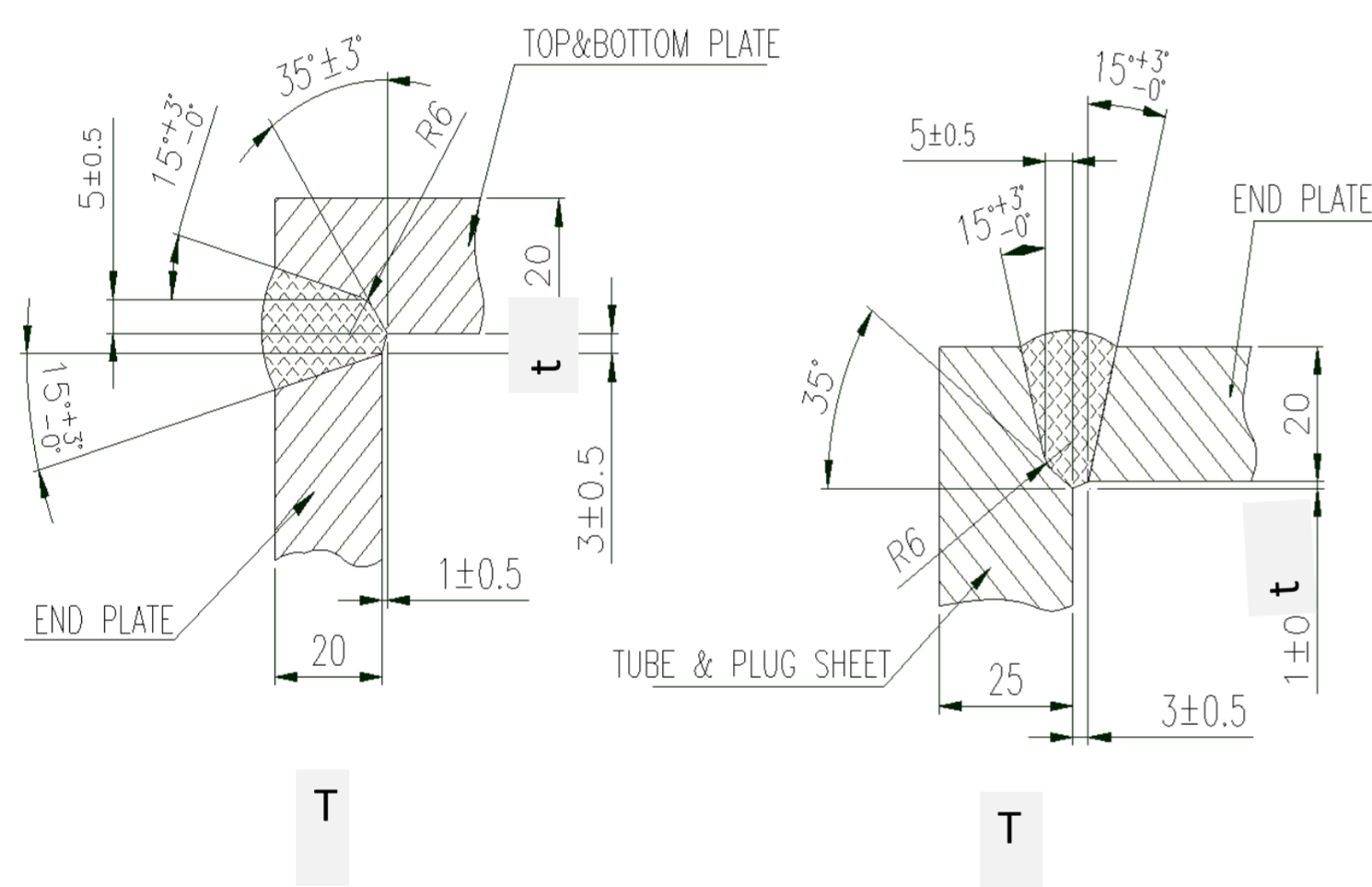

5 & 6

FLANGE (LWN) & OBROND NOZZLE TO TOP & BOTTOM PLATE

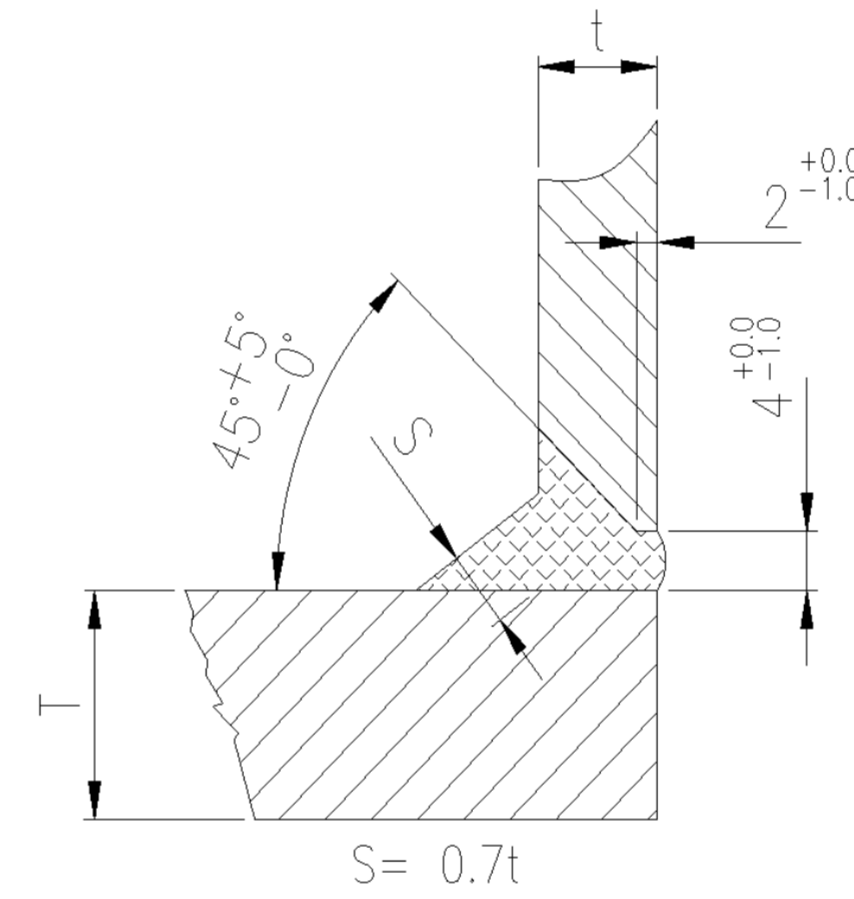

7

NAME PLATE BRACKET AND OTHER ACCESSORIES TO HEADER BOXES

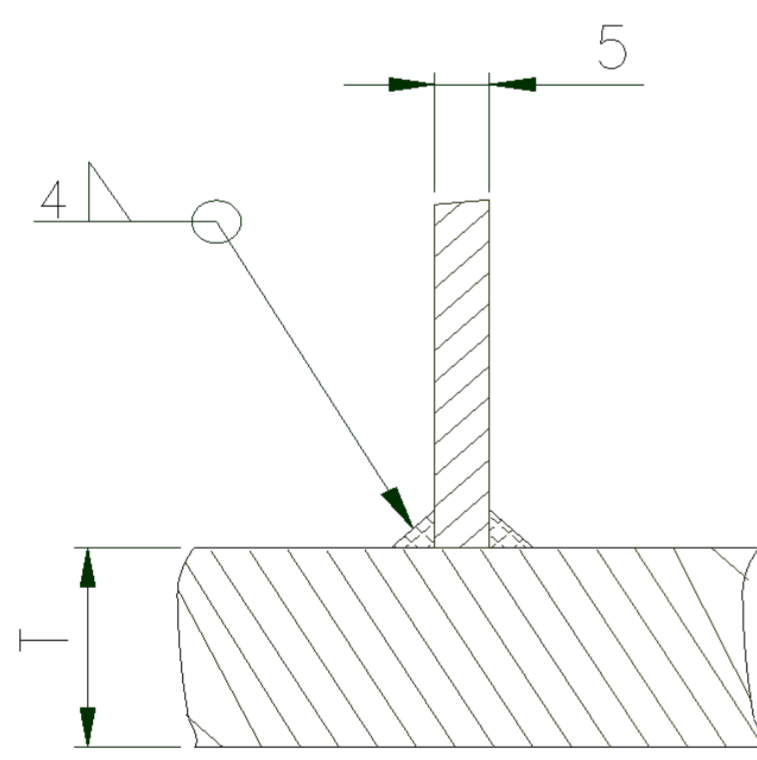

4

FLANGE TO PIPE NOZZLE OR OBROND NOZZLE

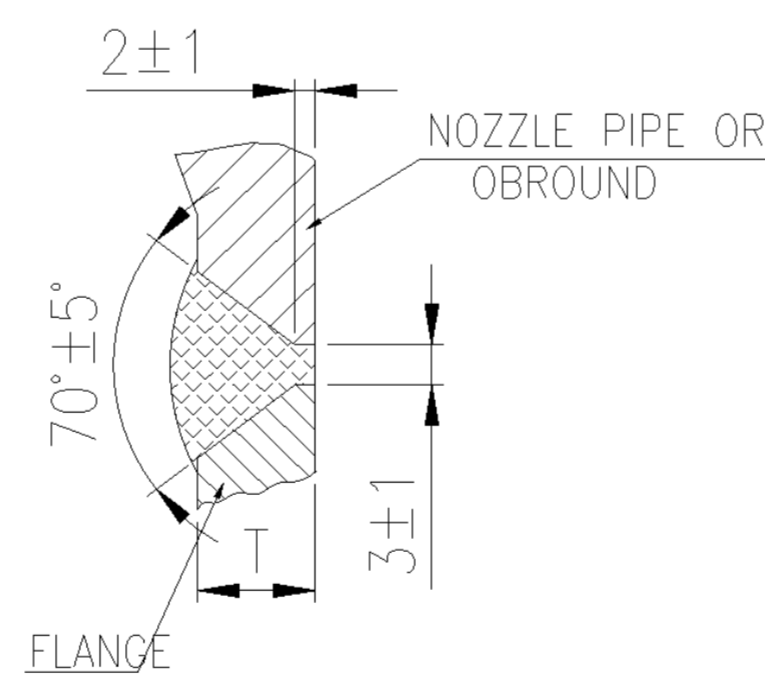

8

Tube To Tube Sheet

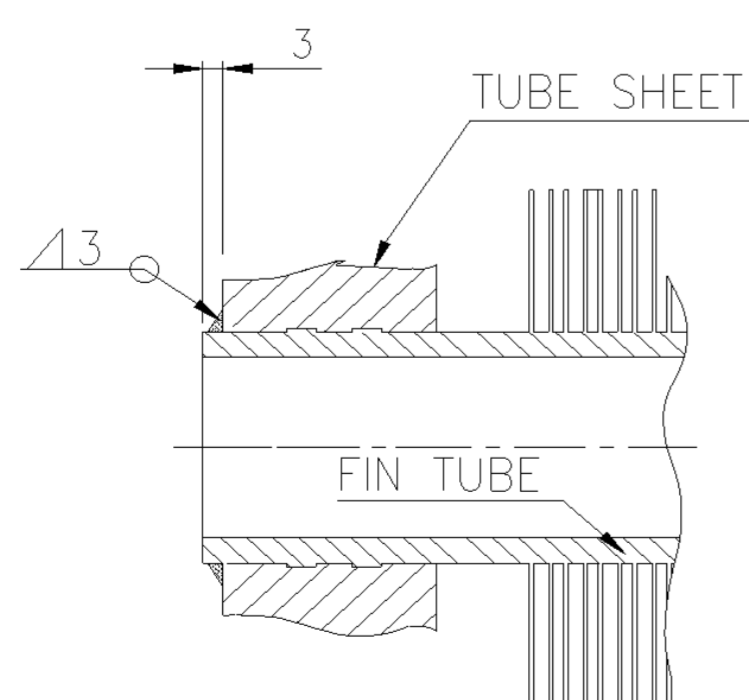

1-WT-108

STRUCTURE - ALL GROOVE JOINT

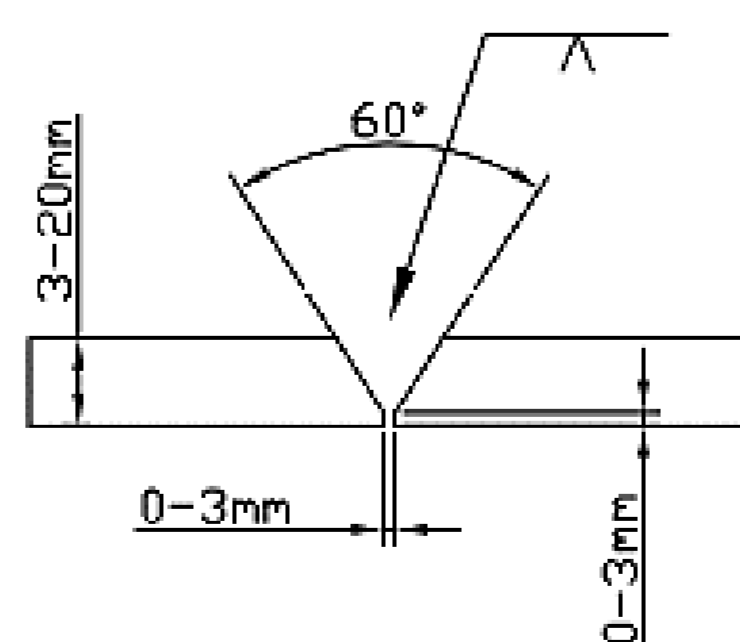

2-WT-111

STRUCTURE- ALL FILLET WELD

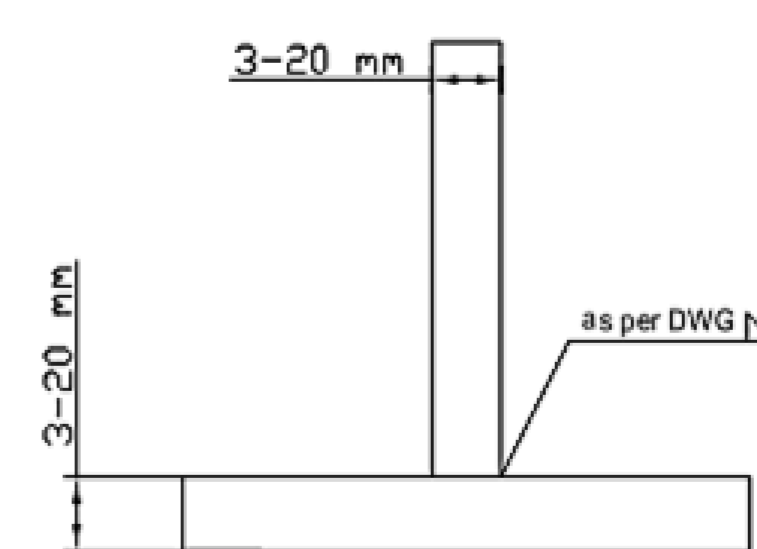

According DWG