



Toase-che Park Sanati Gohar Ofogh
Petrochemical Co.
**CONCEPTUAL, BASIC and DETAIL DESIGN
ENGINEERING OF STYRENE PARK OFFSITE**



Document Title: Steel Structure Calculation

Document No.: EI027-DMF-VD-ST-CAL-004

Rev. R1

Page 1 of 40

STYRENE PARK OFFSITE

Document Title:
Steel Structure Calculation

NATIVE FILE ATTACHED

Rev.	Issued Date	DESCRIPTION	PREPARED	CHECKED	APPROVED
R1	22-07-2024	IFA	J.morsali	J.Beigloo	A.Gholizadeh
R0	01-07-2024	IFA	J.morsali	J.Beigloo	A.Gholizadeh



Toase-che Park Sanati Gohar Ofogh
Petrochemical Co.
**CONCEPTUAL, BASIC and DETAIL DESIGN
ENGINEERING OF STYRENE PARK OFFSITE**



Document Title: Steel Structure Calculation

Document No.: EI027-DMF-VD-ST-CAL-004

Rev. R1

Page 2 of 40

REVISION RECORD SHEET

Page	Revisions							Page	Revisions						
	R0	R1	R2	R3	R4	R5	R6		R0	R1	R2	R3	R4	R5	R6
1	X	X						41							
2	X							42							
3	X							43							
4	X							44							
5	X							45							
6	X							46							
7	X							47							
8	X							48							
9	X							49							
10	X							50							
11	X							51							
12	X	X						52							
13	X							53							
14	X							54							
15	X							55							
16	X							56							
17	X							57							
18	X							58							
19	X							59							
20	X							60							
21	X							61							
22	X							62							
23	X							63							
24	X							64							
25	X							65							
26	X							66							
27	X							67							
28	X							68							
29	X							69							
30	X							70							
31	X							71							
32	X							72							
33	X							73							
34	X							74							
35	X							75							
36	X	X						76							
37	X	X						77							
38	X							78							
39	X							79							
40								80							









 	Toase-eh Park Sanati Gohar Ofogh Petrochemical Co. CONCEPTUAL, BASIC and DETAIL DESIGN ENGINEERING OF STYRENE PARK OFFSITE	 
	Document Title: Steel Structure Calculation	
	Document No.: EI027-DMF-VD-ST-CAL-004	Rev. R1

TABLE OF CONTENTS

Table of Content:

1. SCOPE	4
2. CODE AND STANDARDS	4
3. REFERENCE DRAWING AND GENERAL DOCUMENT	4
4. MATERIAL	4
5. AIR COLLER TYPE	4
5.1. Weight Data	5
6. EXTERNAL LOADS	5
6.1. LOAD CASE DEFINITION.....	5
6.2. DEAD LOAD.....	6
6.2.1. Bundle dry reaction according to table 1:	6
6.2.2. weight of Attachment in FORCED Draft according to table 1:.....	7
6.2.3. Bundle Reaction Due to Fluid (WATER) Weight according to table 1:	7
6.2.4. Nozzle Load acc. to API 661 (1×4”).....	8
6.2.5. Dead Load of Handrail & Grating.....	9
6.3. LIVE LOAD.....	10
6.4. SNOW LOAD.....	11
6.5. SEISMIC LOAD.....	12
6.6. WIND LOAD.....	12
7. BASE PLATE & ANCHOR BOLT DESIGN	13
8. DESIGN & ANALYSIS.....	23
9. COMBINATION	31
10. JOINT REACTION	36
11. Steel Design.....	37
12. Story Drift & Deflection Control.....	40

 	Toase-eh Park Sanati Gohar Ofogh Petrochemical Co. CONCEPTUAL, BASIC and DETAIL DESIGN ENGINEERING OF STYRENE PARK OFFSITE		 
	Document Title: Steel Structure Calculation		
	Document No.: EI027-DMF-VD-ST-CAL-004	Rev. R1	Page 4 of 40

1. SCOPE

This calculation book covers a structural design for AIR COOLERS FOR Asalouyeh Project (ITEM: 1158). 3Dimensional model analyzed by mean of SAP 2000 (version 20.2.0.). This report contains computerized model, load evaluation and design verification.

2. CODE AND STANDARDS

- ASCE7-16, AISC360-16, INBC, PART 6, Standard NO 2800

3. REFERENCE DRAWING AND GENERAL DOCUMENT

- Air Cooler General Arrangement : EI027-DMF-VD-ME-DWG-003

4. MATERIAL

- Structural Steel: ST37 with $F_y = 2400 \text{ kgf/cm}^2$, $F_u = 3700 \text{ kg/cm}^2$

- Setting Bolts: A325 with $F_u = 8000 \text{ kgf/cm}^2$

5. AIR COLLER TYPE

- Descriptions of Supported Equipment → Draft: FORCED





 	Toase-eh Park Sanati Gohar Ofogh Petrochemical Co. CONCEPTUAL, BASIC and DETAIL DESIGN ENGINEERING OF STYRENE PARK OFFSITE	  
	Document Title: Steel Structure Calculation	
	Document No.: EI027-DMF-VD-ST-CAL-004	Rev. R1

Table 1. Weight of equipments For 1 Units (Total Units = 2)

	Total No in one Unit	Total Weight in one Unit (tonf)	Total No. for One Bay	Weight for One Bay (kgf)
Bundle Frame	1	0.865	1	865
Tube Bundle & Headers	1	2.635	1	2635
sum				3500
Water in Tubes & Headers	1	0.48	1	480
sum				480
Plenum	2	0.245	2	490
Fan Ring	2	0.13	2	260
Motor	2	0.07	2	140
Fan	2	0.0275	2	55
Speed Reducer	2	0.25	2	500
Machinery Mount	2	0.32	2	640
Fan Guard	2	0.0325	2	65
sum				2150

6 .EXTERNAL LOADS

6.1. LOAD CASE DEFINITION:

DEAD: Dead load contain weight of component (bundle dry, plenum, fan ring, fan, fan guard, motor, Speed Reducer and Machinery Mount,), dead load of walkway

DEAD-OP: weight of liquid (water) within each tube bundle

DEADS: self-weight of steel structure

DEADN: nozzle load (3 times of API)

LIVE: live load of walkway.

EQX: effect of earth quake at x- direction.

EQY: effect of earth quake at y- direction.

EQXO: Amplified Seismic Load in X Dir. (2EQX)

EQYO: Amplified Seismic Load in Y Dir. (2 EQY)

WX: effect of wind load at x- direction.

WY: effect of wind load at y- direction.

SNOW: Snow Load



Toase-eh Park Sanati Gohar Ofogh
Petrochemical Co.
**CONCEPTUAL, BASIC and DETAIL DESIGN
ENGINEERING OF STYRENE PARK OFFSITE**



Document Title: Steel Structure Calculation

Document No.: EI027-DMF-VD-ST-CAL-004

Rev. R1

Page 6 of 40

6.2. DEAD LOAD

There are one bundle per each bay

6.2.1. Bundle dry according to table 1 & table 1: (figure.1)

Tube bundle , Headers and bundle frame Weight per Item (Dry): 3.5 ton

Tube bundle , Headers and bundle frame Weight of Each Bundle (Dry): 3500 kg → $W_d = 3500 \div (8) = 437.5$ kg

→ $W_d = 437.5$ kg , (Point load on transvers beams)

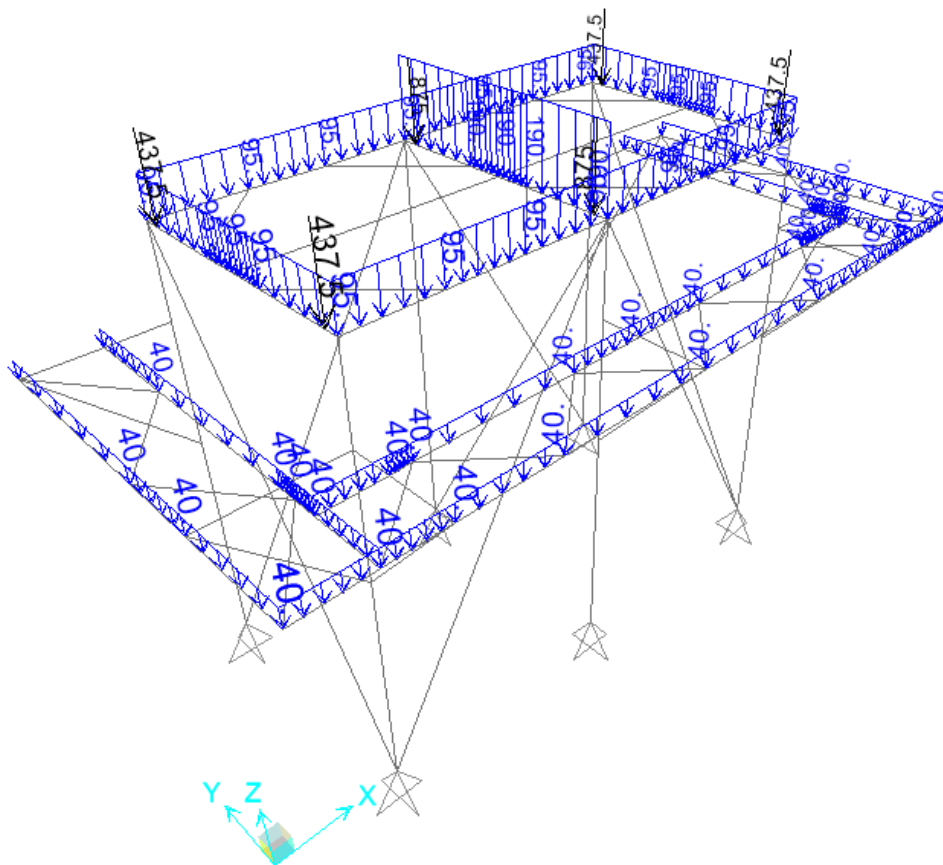







Figure.1

 	Toase-eh Park Sanati Gohar Ofogh Petrochemical Co. CONCEPTUAL, BASIC and DETAIL DESIGN ENGINEERING OF STYRENE PARK OFFSITE	  
	Document Title: Steel Structure Calculation	
	Document No.: EI027-DMF-VD-ST-CAL-004	Rev. R1 Page 7 of 40

6.2.2. Weight of Attachment in FORCED Draft according to table 1: (figure.1)

TOTAL Wequipment for Item = 2150 kg (for 1 Bay)
Wequipment =1075 kg (for One Unit)
L=5.7 m, W=2.8 m → L+2W=11.3 m
Distribution Load : Wequipment =1075/11.3= 95 kg/m

6.2.3. Bundle Reaction Due to Fluid (WATER) Weight according to table 1: (figure.2)

Weight per one unit Item (Operation: Only fluid Weight): 0.48 ton
Weight of each bundle (Operation: Only fluid Weight): 480 kg → $W_o = 480 \div 8 = 60 \text{ kg}$ → $W_o = \sim 60 \text{ kg}$ (Point load on transvers beams)

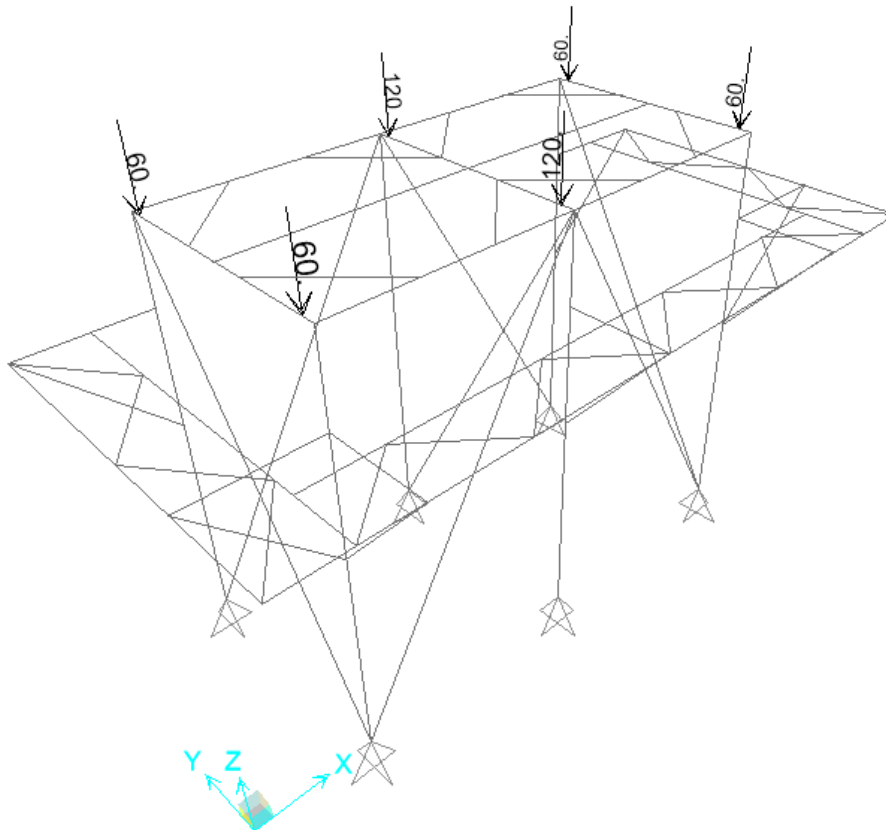

Figure.2

6.2.4. Nozzle Load Acc. to API 661:(figure .3)

Table 2. Nozzle Load for Size 4"

Nozzle Direction	Structure Direction	API Load (kgf)		3×API	Nozzlele QTY.	Final Load
x	x	$F_x =$	334	1002	1	1002
y	z	$F_y =$	267	801	1	801
z	y	$F_z =$	334	1002	1	1002

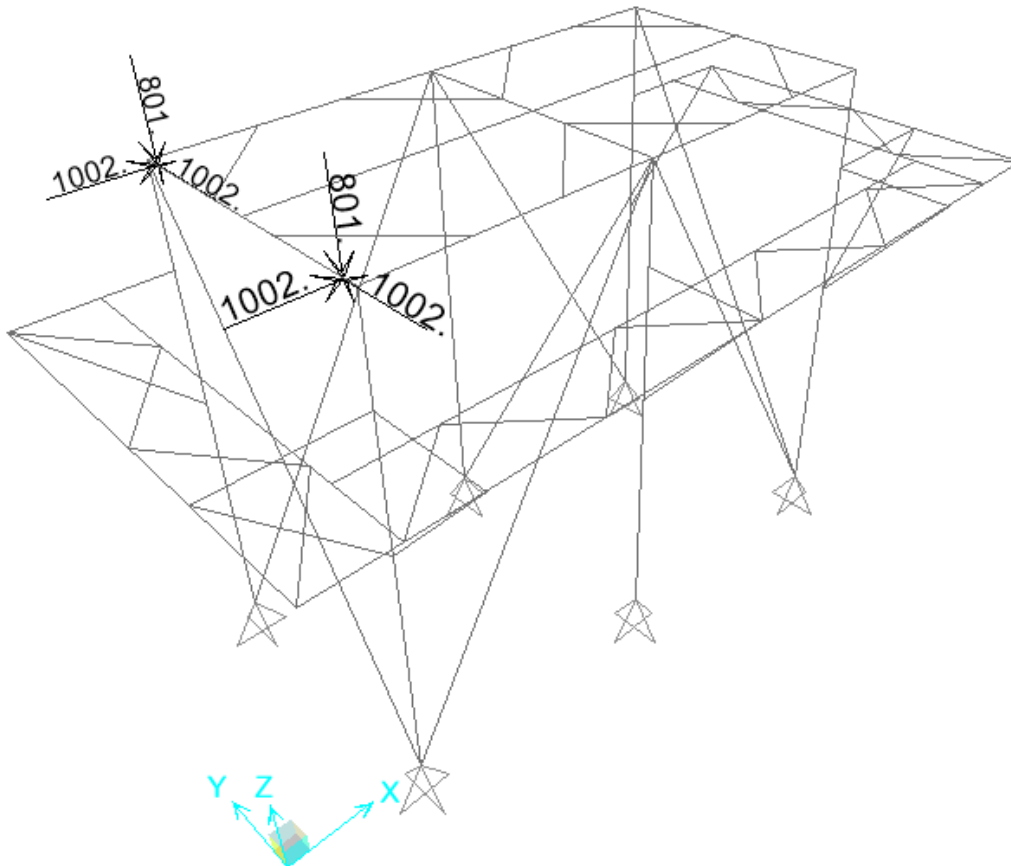

Figure.3



Toase-eh Park Sanati Gohar Ofogh
Petrochemical Co.
**CONCEPTUAL, BASIC and DETAIL DESIGN
ENGINEERING OF STYRENE PARK OFFSITE**



Document Title: Steel Structure Calculation

Document No.: EI027-DMF-VD-ST-CAL-004

Rev. R1

Page 9 of 40

6.2.5. Dead Load of Handrail & Grating: (figure.4)

Weight of Grating = 45 kg/m²

Walkway Frame = 40 kg/m²

Handrail = 15 kg/m²

Width of Walkway = 0.8 m

Dead load for Walkway Beams = $(45+40+15) \times (0.75 \div 2) = 37.5 \text{ kg/m} \rightarrow \text{USE: } 40 \text{ kg/m}$

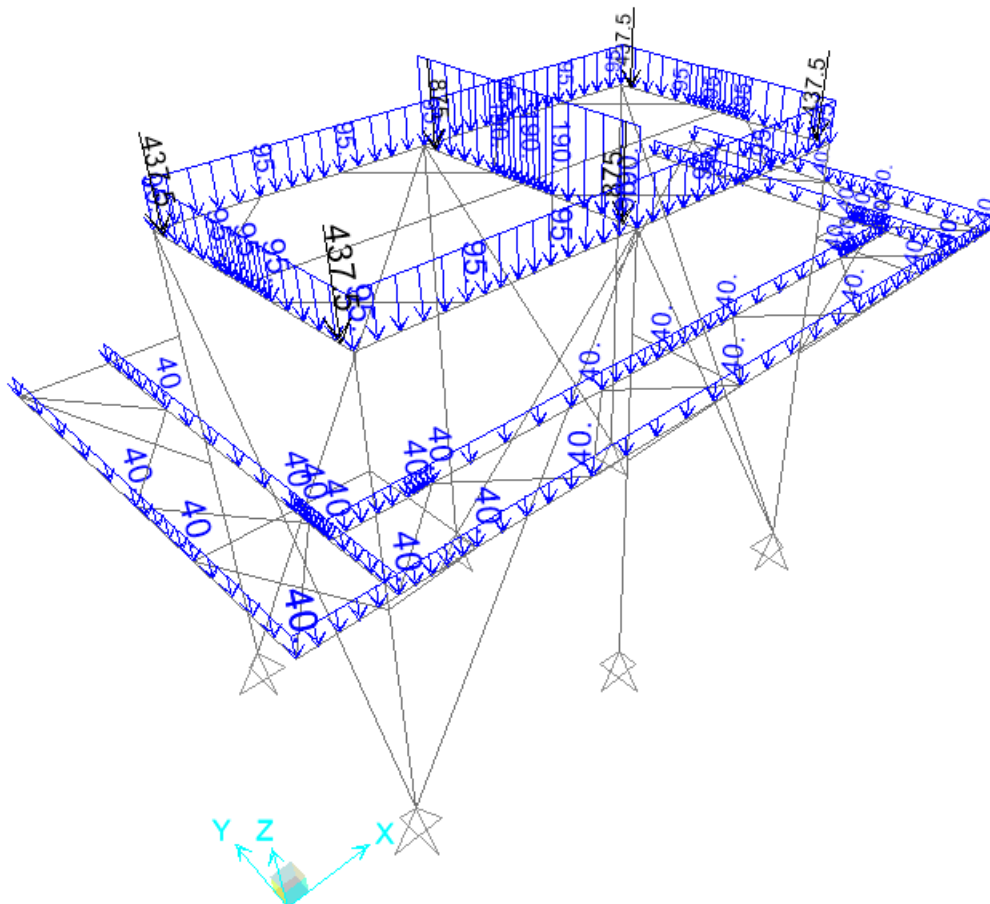

Figure.4



Toase-eh Park Sanati Gohar Ofogh
Petrochemical Co.
**CONCEPTUAL, BASIC and DETAIL DESIGN
ENGINEERING OF STYRENE PARK OFFSITE**



Document Title: Steel Structure Calculation

Document No.: EI027-DMF-VD-ST-CAL-004

Rev. R1

Page 10 of 40

6.3. LIVE LOAD (figure.5)

Live Load According to API 661: 250 kg/m²

Live Load for Walkway Beams (Bearing width = $0.75 \div 2 = 0.375$ m): 100 kg/m → USE: 100kg/m

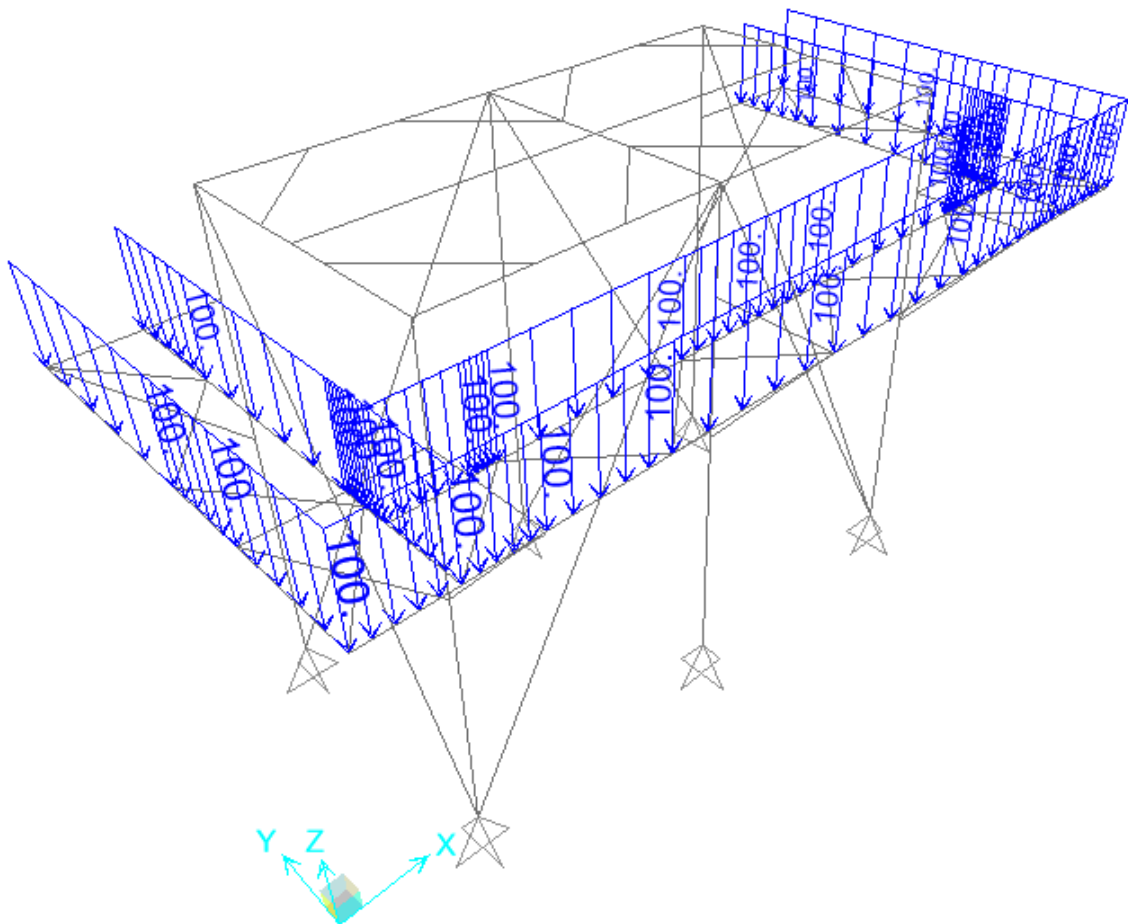

Figure.5



Toase-eh Park Sanati Gohar Ofogh
Petrochemical Co.
**CONCEPTUAL, BASIC and DETAIL DESIGN
ENGINEERING OF STYRENE PARK OFFSITE**



Document Title: Steel Structure Calculation

Document No.: EI027-DMF-VD-ST-CAL-004

Rev. R1

Page 11 of 40

6.4. SNOW LOAD (Figure.6)

According to INBC Part 6:

Ground Snow Loads, $P_s = 50 \text{ kg/m}^2$

Importance factor, $I_s = 1.2$

Exposure factor, $C_n = 1.1$

Thermal factor, $C_h = 1.0$

Slope factor, $C_s = 1.0$

$P_r = I_s C_n C_h C_s P_g \rightarrow P_r = 1.2 \times 1.1 \times 1.0 \times 1.0 \times 50 = 66 \text{ kg/m}^2$

Effective Area: $2.497 \times (6.33) = 15.81 \text{ m}^2$

$F_{\text{snow}} = 66 \times 15.81 \rightarrow F_{\text{snow}} = 1044 \text{ kg} \rightarrow W_s = 1044 \div (8) \rightarrow W_s = 131 \text{ kg}$ (Point Load on Transverse beams)

Snow load for Walk Way Beams = $66 \times 0.375 = 25 \text{ kg/m}$

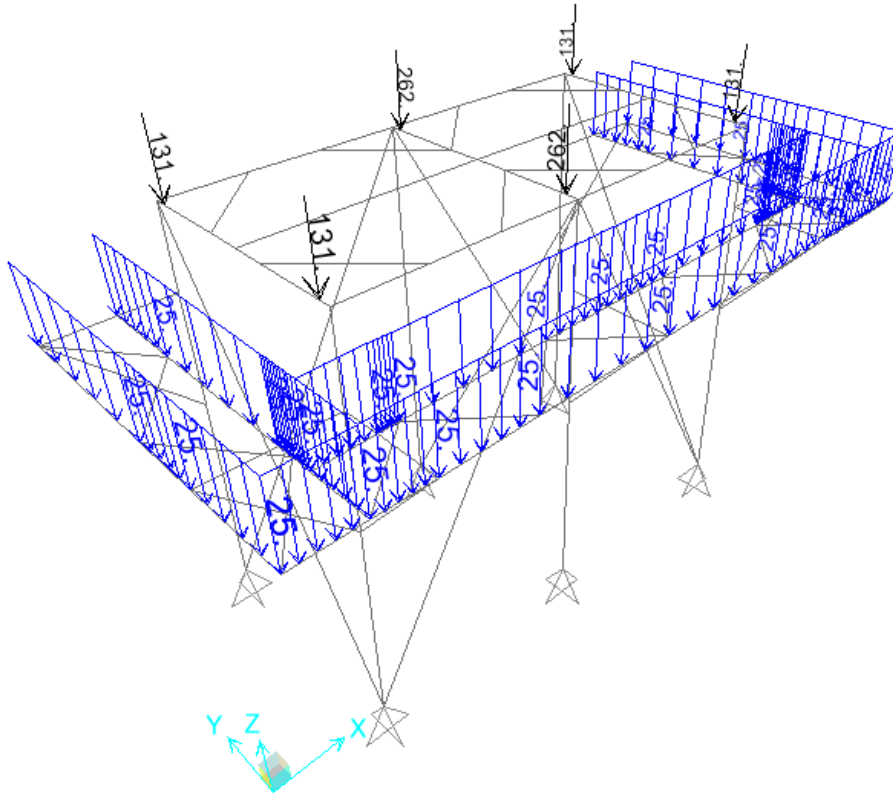





Figure.6

 	Toase-eh Park Sanati Gohar Ofogh Petrochemical Co. CONCEPTUAL, BASIC and DETAIL DESIGN ENGINEERING OF STYRENE PARK OFFSITE	 
	Document Title: Steel Structure Calculation	
	Document No.: EI027-DMF-VD-ST-CAL-004	Rev. R1

6.5. SEISMIC LOAD

Air cooler support (steel structure) designed in accordance with Standard Standard NO 2800:

According to Standard NO 2800 : Soil Type = IV & A=0.3, I=1.4 , R=3.5

According to Standard No 2800:

$$T=0.08H^{0.75} =0.27s$$

$$T_0= 0.15 , T_s=1 \rightarrow B=2.75$$

$$C = \frac{ABI}{R} W = 0.33W$$

W= tube bundles (full of water)+ weight of all equipment (plenums+ fan guards+ fan Rings+ fans+ motor+ speed reducers) + self-weight of structure + nozzle load+ 0.2(access platform load+ Snow) = **12078.6** kg

Seismic base shear:

→For Ordinary braced frame $V = 0.33 *12.0786= 3.9859\text{ton}$

For Ordinary braced frame:





Table 6. Mass Source for one Unit (Total Units=2)

Output Case	Global FZ (Tonf)	Multiplier	Mass Source
DEAD	6.095	1	6.095
DEAD-OP	0.48	1	0.48
DEAD-S	3.412	1	3.412
DEAD-N	1.602	1	1.602
LIVE	1.12	0.2	0.224
SNOW	1.328	0.2	0.2656
Sum			12.0786

6.6. WIND LOAD

Auto WIND used for Columns, Bracing and Walkway According to ASCE 7-16

Acc.to **Client Spec**, Basic wind velocity = **125** Km/hr & Exposure Category: C

 	Toase-eh Park Sanati Gohar Ofogh Petrochemical Co. CONCEPTUAL, BASIC and DETAIL DESIGN ENGINEERING OF STYRENE PARK OFFSITE	 		
	Document Title: Steel Structure Calculation		Rev. R1	Page 13 of 40
	Document No.: EI027-DMF-VD-ST-CAL-004			

7.7 BASE PLATE & ANCHOR BOLT DESIGN

Design

Name	Base Plate Connection
Description	
Analysis	Stress, strain/ simplified loading
Design code	AISC - LRFD (2022)

Members





Geometry

Name	Cross-section	β - Direction [°]	γ - Pitch [°]	α - Rotation [°]	Offset ex [mm]	Offset ey [mm]	Offset ez [mm]
COL	1 - CON1(HEA160)	0.0	90.0	0.0	0	0	0

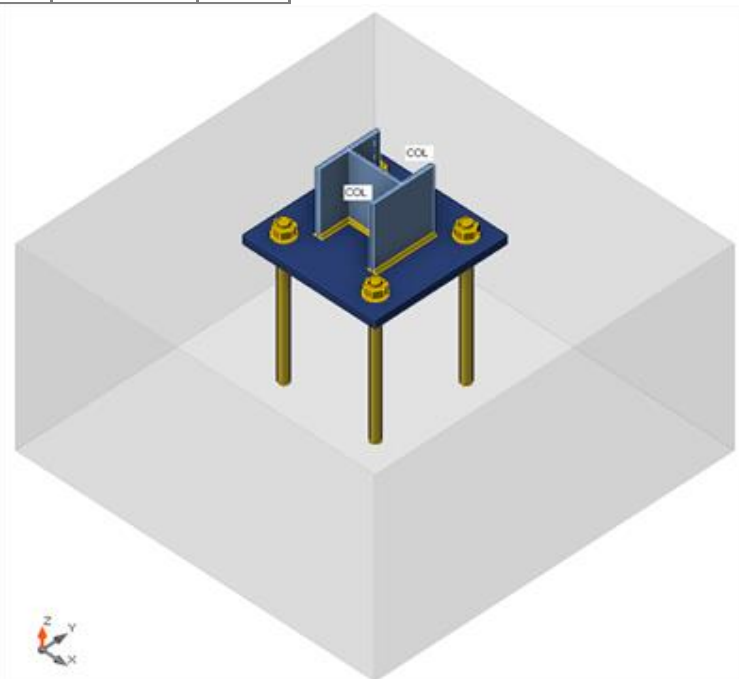
Supports and forces

Name	Support	Forces in	X [mm]
COL / end		Node	0



 	Toase-eh Park Sanati Gohar Ofogh Petrochemical Co. CONCEPTUAL, BASIC and DETAIL DESIGN ENGINEERING OF STYRENE PARK OFFSITE	 
	Document Title: Steel Structure Calculation	
	Document No.: EI027-DMF-VD-ST-CAL-004	Rev. R1 Page 14 of 40

Cross-sections

Name	Material
1 - CON1(HEA160)	A36

Anchors

Name	Diameter [mm]	f_y [MPa]	f_u [MPa]	Gross area [mm ²]
24 A325M	24	660.0	830.0	452

Load effects (Equilibrium not required)

Name	Member	N [kN]	Vy [kN]	Vz [kN]	Mx [kNm]	My [kNm]	Mz [kNm]
LE1	COL / End	-127.0	34.0	47.0	0.0	0.0	0.0





Foundation block

Item	Value	Unit
CB 1		
Dimensions	950 x 950	mm
Depth	600	mm
Anchor	24 A325M	
Anchoring length	400	mm
Shear force transfer	Anchors	

Check

Summary

Name	Value	Check status
Analysis	100.0%	OK
Plates	$0.0 < 5.0\%$	OK
Anchors	$70.5 < 100\%$	OK
Welds	$29.8 < 100\%$	OK
Concrete block	$4.8 < 100\%$	OK
Buckling	Not calculated	

 	Toase-eh Park Sanati Gohar Ofogh Petrochemical Co. CONCEPTUAL, BASIC and DETAIL DESIGN ENGINEERING OF STYRENE PARK OFFSITE	 
	Document Title: Steel Structure Calculation	
	Document No.: EI027-DMF-VD-ST-CAL-004	Rev. R1

Plates

Name	t_p [mm]	Loads	σ_{Ed} [MPa]	ϵ_{Pl} [%]	$\sigma_{c,Ed}$ [MPa]	Status
COL-bfl 1	9.0	LE1	164.8	0.0	0.0	OK
COL-tfl 1	9.0	LE1	97.1	0.0	0.0	OK
COL-w 1	6.0	LE1	116.6	0.0	0.0	OK
BP1	25.0	LE1	30.4	0.0	0.0	OK

Design data

Material	F_y [MPa]	ϵ_{lim} [%]
A36	248.2	5.0

Symbol explanation

t_p	Plate thickness
σ_{Ed}	Equivalent stress
ϵ_{Pl}	Plastic strain
$\sigma_{c,Ed}$	Contact stress
F_y	Yield strength
ϵ_{lim}	Limit of plastic strain

Detailed result for COL-bfl 1

Design values used in the analysis

$$\phi F_y = 223.4 \text{ MPa}$$

Where:

$$F_y = 248.2 \text{ MPa} \quad \text{– characteristic yield strength}$$

$$\phi = 0.90 \quad \text{– resistance factor for steel material AISC 360-22 – B3.1}$$



Toase-eh Park Sanati Gohar Ofogh
Petrochemical Co.
**CONCEPTUAL, BASIC and DETAIL DESIGN
ENGINEERING OF STYRENE PARK OFFSITE**



Document Title: Steel Structure Calculation

Document No.: EI027-DMF-VD-ST-CAL-004

Rev. R1

Page 16 of 40

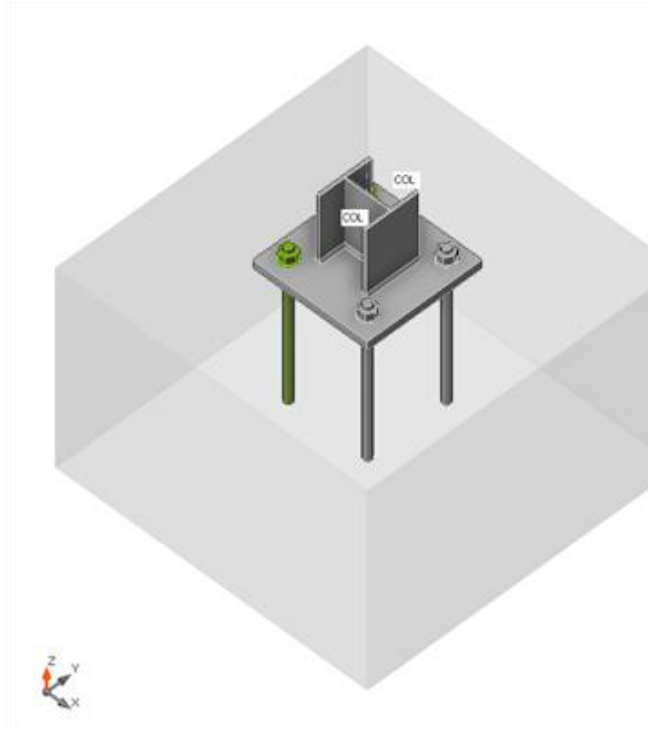

Overall check, LE1

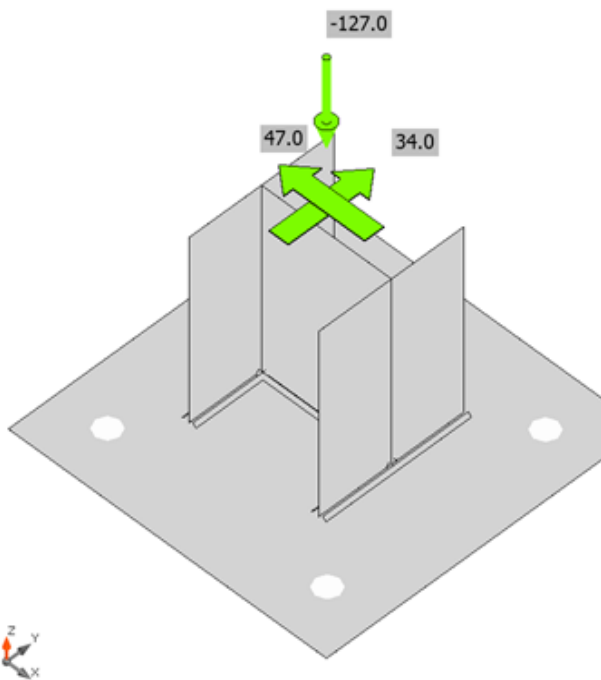

Strain check, LE1

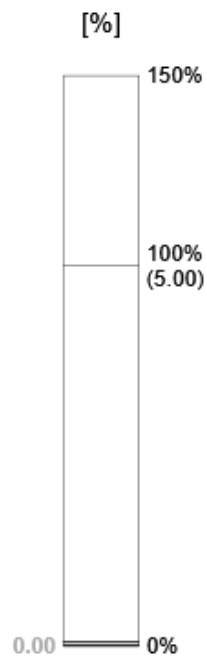



Toase-eh Park Sanati Gohar Ofogh
Petrochemical Co.
**CONCEPTUAL, BASIC and DETAIL DESIGN
ENGINEERING OF STYRENE PARK OFFSITE**



Document Title: Steel Structure Calculation

Document No.: EI027-DMF-VD-ST-CAL-004



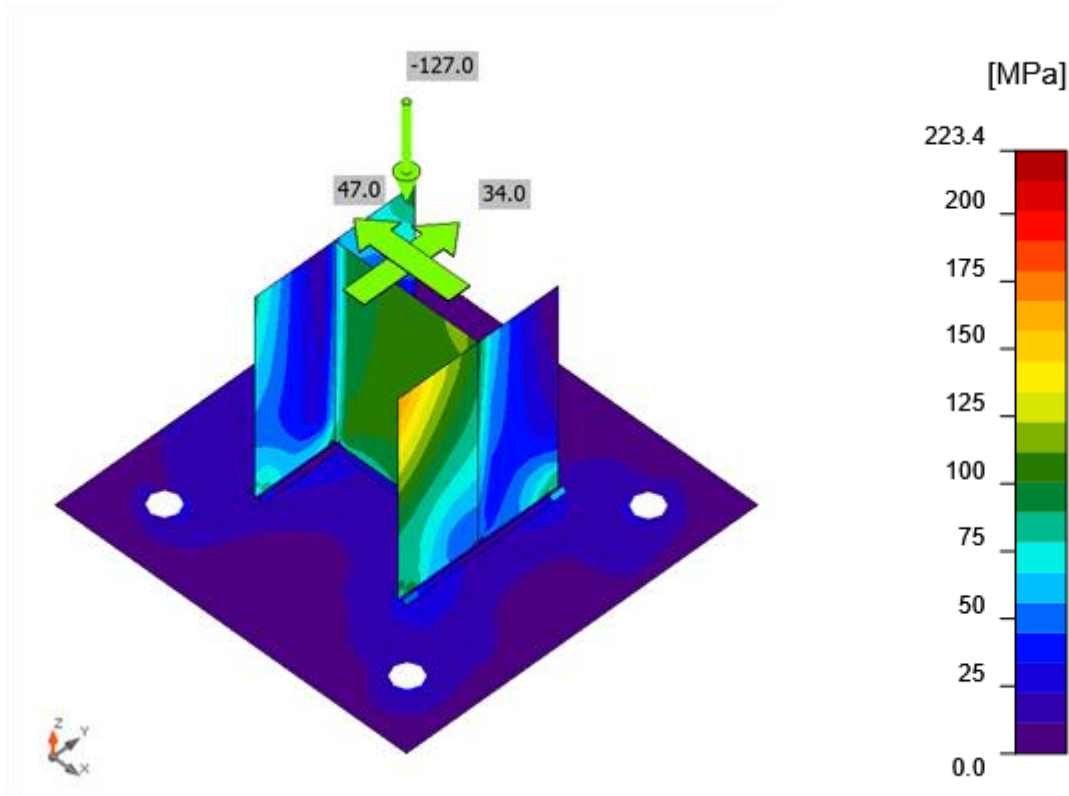

Rev. R1

Page 17 of 40



Equivalent stress, LE1

Shape	Item	Loads	N_f [kN]	V [kN]	ϕV_{cbg} [kN]	ϕV_{cp} [kN]	U_{t_t} [%]	U_{t_s} [%]	$U_{t_{ts}}$ [%]	Detailing	Status
	A1	LE1	0.0	14.8	70.9	444.6	0.0	70.5	55.8	OK	OK
	A2	LE1	0.0	14.3	70.9	444.6	0.0	70.5	55.8	OK	OK
	A3	LE1	0.0	14.3	77.9	444.6	0.0	53.1	34.8	OK	OK
	A4	LE1	0.0	14.5	-	444.6	0.0	13.0	3.4	OK	OK

 	Toase-eh Park Sanati Gohar Ofogh Petrochemical Co. CONCEPTUAL, BASIC and DETAIL DESIGN ENGINEERING OF STYRENE PARK OFFSITE	 
	Document Title: Steel Structure Calculation	
	Document No.: EI027-DMF-VD-ST-CAL-004	Rev. R1 Page 18 of 40

Design data

Grade	ϕN_{sa} [kN]	ϕV_{sa} [kN]
24 A325M - 1	205.1	114.3

Symbol explanation

N_f	Tension force
V	Resultant of bolt shear forces V_y and V_z in shear planes
ϕV_{cbg}	Concrete breakout strength in shear – ACI 318-14 – 17.5.2
ϕV_{cp}	Concrete pryout strength in shear – ACI 318-14 – 17.5.3
U_t	Utilization in tension
U_s	Utilization in shear
U_{ts}	Utilization in tension and shear
ϕN_{sa}	Steel strength of anchor in tension - ACI 318-14 – 17.4.1
ϕV_{sa}	Steel strength of anchor in shear - ACI 318-14 – 17.5.1

Detailed result for A1

Anchor tensile resistance (ACI 318-14 – 17.4.1)

$$\phi N_{sa} = \phi \cdot A_{se,N} \cdot f_{uta} = 205.1 \text{ kN} \geq N_f = 0.0 \text{ kN}$$

Where:

$$\phi = 0.70 \quad \text{– resistance factor}$$

$$A_{se,N} = 353 \text{ mm}^2 \quad \text{– tensile stress area}$$

– specified tensile strength of anchor steel:

$$f_{uta} = \min(860 \text{ MPa}, 1.9 \cdot f_{ya}, f_u)$$

, where:

$$f_{uta} = 830.0 \text{ MPa} \quad f_{ya} = 660.0 \text{ MPa} \quad \text{– specified yield strength of anchor steel}$$

$$f_u = 830.0 \text{ MPa} \quad \text{– specified ultimate strength of anchor steel}$$

Shear resistance (ACI 318-14 – 17.5.1)

$$\phi V_{sa} = \phi \cdot 0.6 \cdot A_{se,V} \cdot f_{uta} = 114.3 \text{ kN} \geq V = 14.8 \text{ kN}$$

Where:

$$\phi = 0.65 \quad \text{– resistance factor}$$



Toase-eh Park Sanati Gohar Ofogh
Petrochemical Co.
**CONCEPTUAL, BASIC and DETAIL DESIGN
ENGINEERING OF STYRENE PARK OFFSITE**



Document Title: Steel Structure Calculation

Document No.: EI027-DMF-VD-ST-CAL-004

Rev. R1

Page 19 of 40

$$A_{se,V} = 353 \text{ mm}^2 \quad \text{– tensile stress area}$$

$$f_{uta} = 830.0 \text{ MPa} \quad \text{– specified tensile strength of anchor steel:}$$

$$f_{uta} = \min(860 \text{ MPa}, 1.9 \cdot f_{ya}, f_u)$$

, where:

$$f_{ya} =$$

660.0 MPa – specified yield strength of anchor steel

$$f_u =$$

830.0 MPa – specified ultimate strength of anchor steel

Concrete shear breakout check (ACI 318-14 – 17.5.2)

The check is performed for group of anchors that form common shear breakout cone: A1, A2

$$\phi V_{cbg} = \phi \cdot \frac{A_{Vc}}{A_{Vc0}} \cdot \Psi_{ec,V} \cdot \Psi_{ed,V} \cdot \Psi_{c,V} \cdot \Psi_{h,V} \cdot \Psi_{\alpha,V} \cdot 70. \frac{\text{k}}{\text{N}} \geq V_g = 50. \frac{\text{k}}{\text{N}}$$

Where:

$$V_g = 50.0 \text{ kN} \quad \text{– sum of shear forces of anchors on common base plate}$$

$$\phi = 0.65 \quad \text{– resistance factor}$$

$$A_{Vc} = 504450 \text{ mm}^2 \quad \text{– projected concrete failure area of an anchor or group of anchors}$$

$$A_{Vc0} = 563922 \text{ mm}^2 \quad \text{– projected concrete failure area of one anchor when not limited by corner influences, spacing or member thickness}$$

$$\Psi_{ec,V} = 1.00 \quad \text{– modification factor for anchor groups loaded eccentrically in shear:}$$

$$\Psi_{ec,V} = \frac{1}{1 + \frac{2e'_V}{3c_{a1}}}$$

, where:

$$e'_V =$$

0 mm – shear load eccentricity

$$c_{a1} =$$

354 mm – edge distance in direction of the load

$$c_{a1} =$$

354 mm – edge distance in direction of the load

$$\Psi_{ed,V} = 0.90 \quad \text{– modification factor for edge effect:}$$

$$\Psi_{ed,V} = 0.7 + 0.3 \cdot \frac{c_{a2}}{1.5 \cdot c_{a1}} \leq 1$$

, where:

$$c_{a1} =$$

354 mm – edge distance in direction of the load





$$c_{a1} =$$

354 mm – edge distance in direction of the load

$$c_{a2} =$$

355 mm – edge distance in direction perpendicular to the load

$$\Psi_{c,V} = 1.00 \quad \text{– modification factor for concrete conditions}$$

 	Toase-eh Park Sanati Gohar Ofogh Petrochemical Co. CONCEPTUAL, BASIC and DETAIL DESIGN ENGINEERING OF STYRENE PARK OFFSITE	 
	Document Title: Steel Structure Calculation	
	Document No.: EI027-DMF-VD-ST-CAL-004	Rev. R1

$\Psi_{h,V} = 1.00$ – modification factor for anchors located in a shallow concrete member:
 $\Psi_{h,V} = \sqrt{\frac{1.5 \cdot c_{a1}}{h_a}} \geq 1$
 , where:
 $h_a =$
 600 mm – thickness of member in which an anchor is anchored measured parallel to anchor axis
 $\Psi_{\alpha,V} = 1.05$ – modification factor for anchors loaded at an angle with the concrete edge
 $\Psi_{\alpha,V} = \sqrt{\frac{1}{(\cos \alpha_V)^2 + (0.5 \cdot \sin \alpha_V)^2}}$
 , where:
 $\alpha_V =$
 19.9 ° – angle between direction of shear force and direction perpendicular to concrete edge
 $V_b = 129.4 \text{ kN}$ – basic concrete breakout strength of a single anchor in shear:
 $V_b = \min(0.6 \cdot (\frac{l_e}{d_a})^{0.2} \cdot \lambda_a \cdot \sqrt{d_a} \cdot \sqrt{f_c} \cdot c_{a1}^{1.5}, 3.7 \cdot \lambda_a \cdot \sqrt{f_c} \cdot c_{a1}^{1.5})$
 , where:
 $l_e =$
 192 mm – effective length
 $d_a =$
 24 mm – anchor diameter
 $\lambda_a =$
 1.00 – modification factor for lightweight concrete
 $f_c =$
 27.6 MPa – concrete compressive strength
 $c_{a1} =$
 354 mm – edge distance in direction of the load
 $c_{a2} =$
 354 mm – edge distance in direction of the load

Concrete pryout resistance (ACI 318-14 – 17.5.3)





The check is performed for group of anchors on common base plate

$$\phi V_{cp} = \phi \cdot k_{cp} \cdot 444.6 \text{ kN} \geq V_{\Sigma} = 58.0 \text{ kN}$$

Where:

$\phi = 0.65$ – resistance factor
 $k_{cp} = 2.00$ – concrete pry-out factor
 $N_{cp} = 342.0 \text{ kN}$ – concrete cone tension break-out resistance in case all anchors are in tension
 $V_{\Sigma} = 58.0 \text{ kN}$ – sum of shear forces of anchors on common base plate

Interaction of tensile and shear forces (ACI 318-14 – R17.6)

 	Toase-eh Park Sanati Gohar Ofogh Petrochemical Co. CONCEPTUAL, BASIC and DETAIL DESIGN ENGINEERING OF STYRENE PARK OFFSITE		 	
	Document Title: Steel Structure Calculation			
	Document No.: EI027-DMF-VD-ST-CAL-004		Rev. R1	Page 21 of 40

$$U_{tt}^{5/3} + U_{tz}^{5/3} = 0.56 \leq 1.0$$

Where:

$U_{tt} = 0.00$ – maximum ratio of factored tensile force and tensile resistance determined from all appropriate failure modes

$U_{tz} = 0.70$ – maximum ratio of factored shear force and shear resistance determined from all appropriate failure modes

Welds





Item	Edge	Xu	t _w [mm]	w [mm]	L [mm]	L _c [mm]	Loads	F _n [kN]	φR _n [kN]	Ut [%]	Detailing	Status
BP1	COL-bfl 1	E70xx	4.9	7.0	159	13	LE1	6.0	20.1	29.8	OK	OK
		E70xx	4.9	7.0	159	13	LE1	5.4	20.2	26.9	OK	OK
BP1	COL-tfl 1	E70xx	4.9	7.0	159	13	LE1	4.7	19.8	23.6	OK	OK
		E70xx	4.9	7.0	159	13	LE1	4.1	19.4	21.2	OK	OK
BP1	COL-w 1	E70xx	4.9	7.0	142	13	LE1	2.5	15.6	15.7	OK	OK
		E70xx	4.9	7.0	142	13	LE1	2.4	15.1	15.8	OK	OK

Design data

Material	F _{exx} [MPa]
E70xx	482.6

Symbol explanation

- t_w Throat thickness of weld
- w Leg size of weld
- L Length of weld
- L_c Length of weld critical element
- F_n Force in weld critical element
- φR_n Weld resistance - AISC 360-22 – J2-4

 	Toase-eh Park Sanati Gohar Ofogh Petrochemical Co. CONCEPTUAL, BASIC and DETAIL DESIGN ENGINEERING OF STYRENE PARK OFFSITE	  
	Document Title: Steel Structure Calculation	
	Document No.: EI027-DMF-VD-ST-CAL-004	Rev. R1

- Ut Utilization
 ▲ Fillet weld
 F_{EXX} Ultimate strength as rated by electrode classification number

Detailed result for BP1 / COL-bfl 1

Weld resistance check (AISC 360-22 – J2-4)

$$\phi R_n = \phi \cdot F_{TW} \cdot 20.1 \text{ kN} \geq F_n = 6.0 \text{ kN}$$

Where:

$$F_{TW} = 406.7 \text{ MPa} \quad \text{– nominal stress of weld material:}$$

$$F_{TW} = 0.6 \cdot F_{EXX} \cdot (1 + 0.5 \cdot \sin^{1.5} \theta)$$

, where:

$$F_{EXX} =$$

482.6 MPa – electrode classification number, i.e. minimum specified tensile strength

$$\theta =$$

60.3° – angle of loading measured from the weld longitudinal axis

$$A_{we} = 66 \text{ mm}^2$$

– effective area of weld critical element

$$\phi = 0.75$$

– resistance factor for welded connections

Item	Loads	A ₁ [mm ²]	A ₂ [mm ²]	σ [MPa]	ϕf _{p,max} [MPa]	Ut [%]	Status
CB 1	LE1	86506	705173	1.5	30.5	4.8	OK

Symbol explanation

- A₁ Loaded area
 A₂ Supporting area
 σ Average stress in concrete
 ϕf_{p,max} Concrete bearing resistance
 Ut Utilization

Detailed result for CB 1

Concrete block compressive resistance check (AISC 360-22 – J8)

$$\phi_c f_{p,max} = 30.5 \text{ MPa} \geq \sigma = 1.5 \text{ MPa}$$

Where:

$$f_{p,max} = 46.9 \text{ MPa} \quad \text{– concrete block design bearing strength:}$$

$$f_{p,max} = 0.85 \cdot f_c \cdot \sqrt{\frac{A_2}{A_1}} \leq 1.7 \cdot f_c$$

, where:



Toase-eh Park Sanati Gohar Ofogh
 Petrochemical Co.
**CONCEPTUAL, BASIC and DETAIL DESIGN
 ENGINEERING OF STYRENE PARK OFFSITE**



Document Title: Steel Structure Calculation

Document No.: EI027-DMF-VD-ST-CAL-004

Rev. R1

Page 24 of 40

1158.sdb

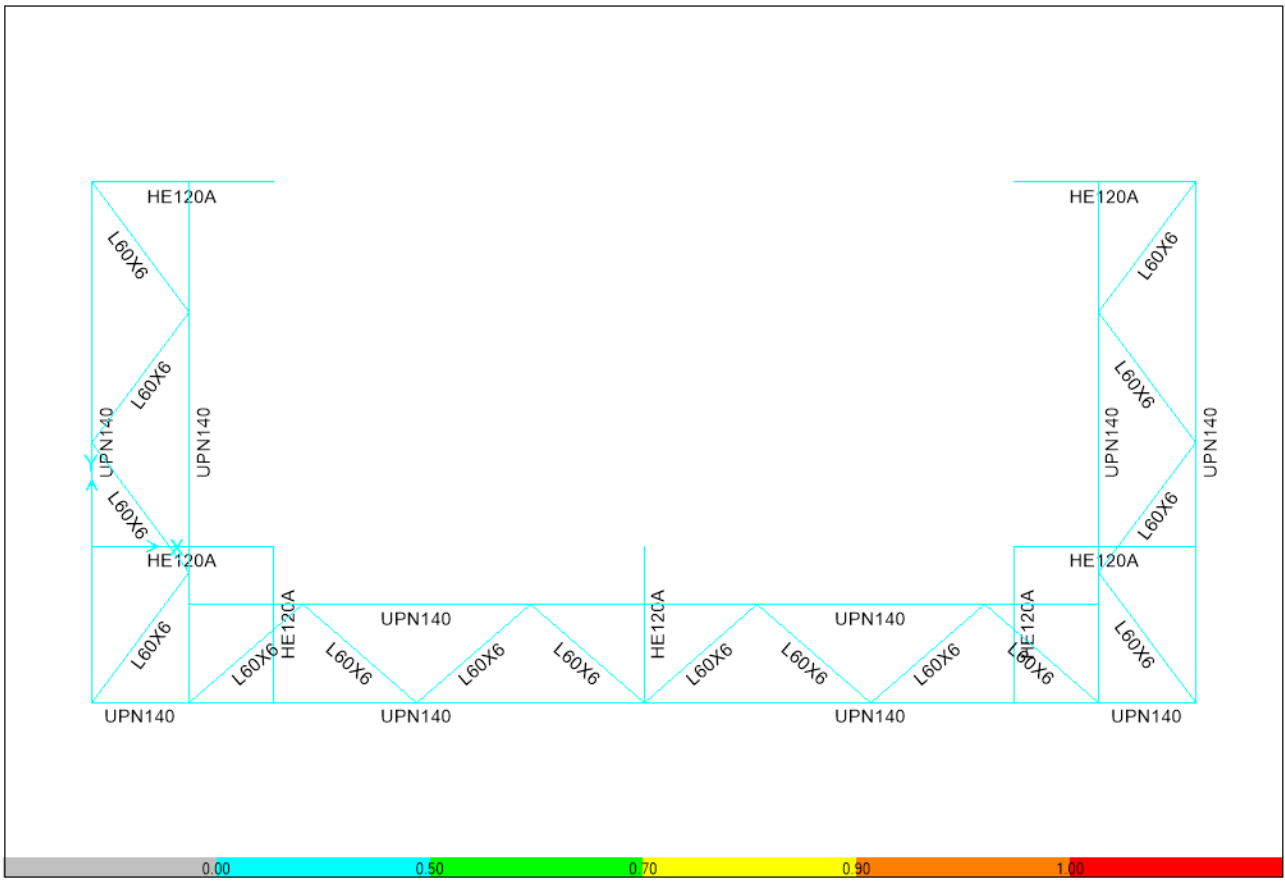

SAP2000 20.2.0

Steel Design Sections (AISC 360-16)

Kgf, m, C



Toase-eh Park Sanati Gohar Ofogh
 Petrochemical Co.
CONCEPTUAL, BASIC and DETAIL DESIGN
ENGINEERING OF STYRENE PARK OFFSITE



Document Title: Steel Structure Calculation

Document No.: EI027-DMF-VD-ST-CAL-004

Rev. R1

Page 25 of 40

1158.sdb

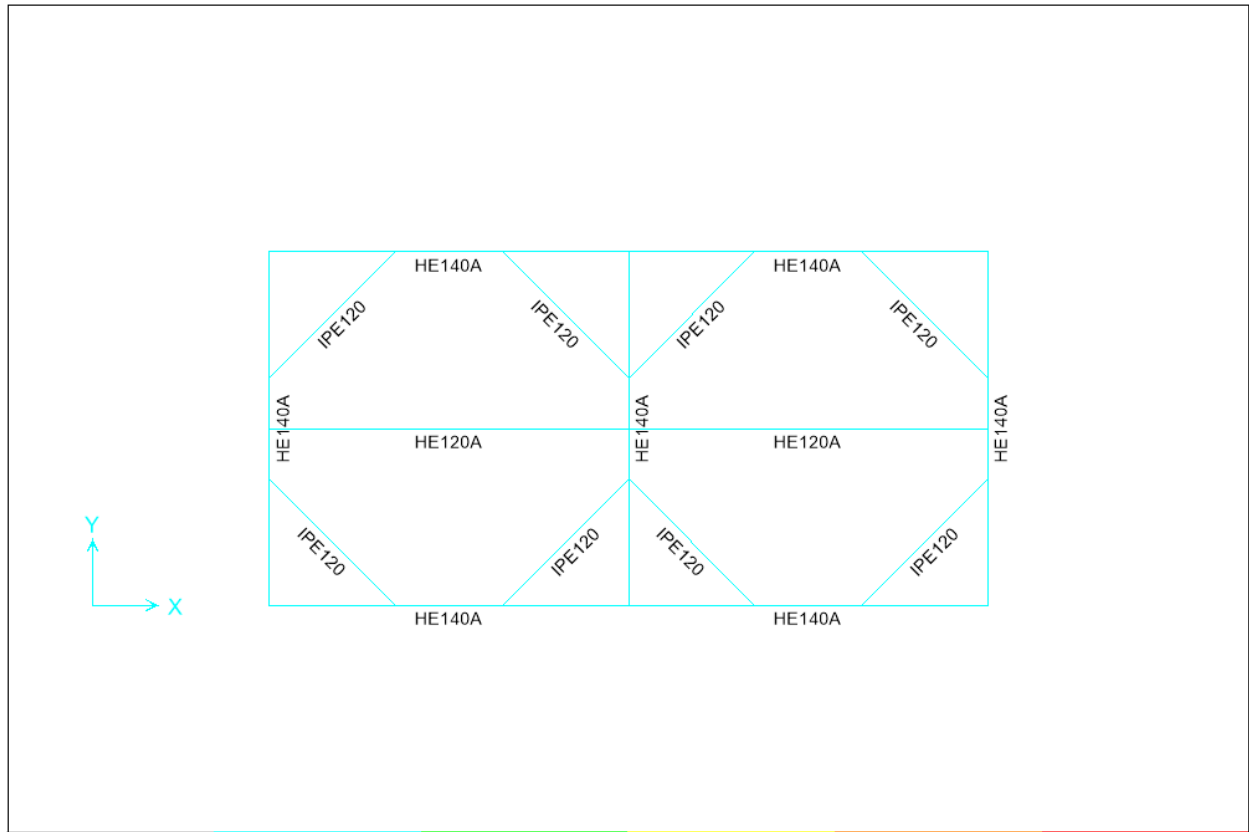

SAP2000 20.2.0

Steel Design Sections (AISC 360-16)

Kgf, m, C



Toase-eh Park Sanati Gohar Ofogh
Petrochemical Co.
**CONCEPTUAL, BASIC and DETAIL DESIGN
ENGINEERING OF STYRENE PARK OFFSITE**



Document Title: Steel Structure Calculation

Document No.: EI027-DMF-VD-ST-CAL-004

Rev. R1

Page 26 of 40

1158.sdb

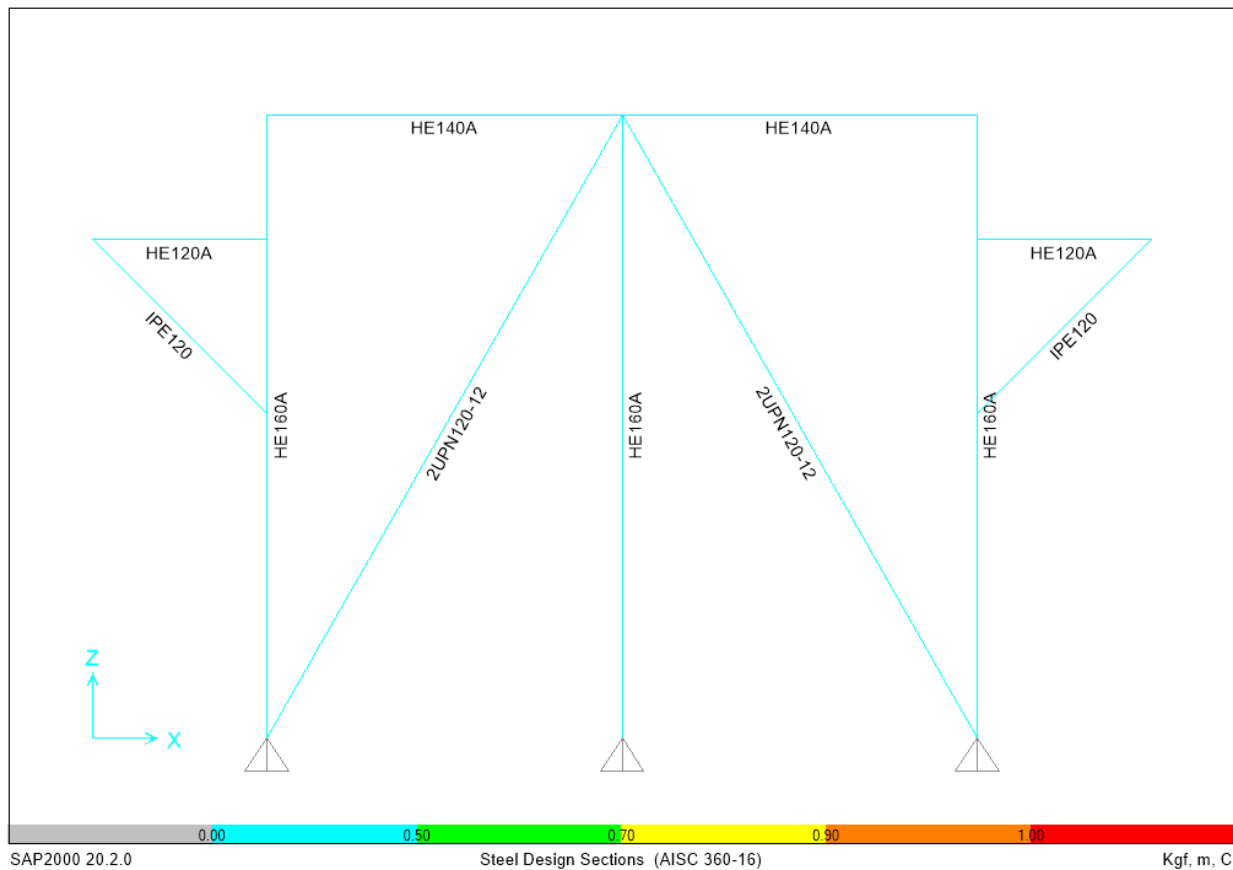

SAP2000 20.2.0

Steel Design Sections (AISC 360-16)

Kgf, m, C



Toase-eh Park Sanati Gohar Ofogh
Petrochemical Co.
**CONCEPTUAL, BASIC and DETAIL DESIGN
ENGINEERING OF STYRENE PARK OFFSITE**



Document Title: Steel Structure Calculation

Document No.: EI027-DMF-VD-ST-CAL-004

Rev. R1

Page 27 of 40

1158.sdb



SAP2000 20.2.0

Steel Design Sections (AISC 360-16)

Kgf, m, C



Toase-eh Park Sanati Gohar Ofogh
Petrochemical Co.
**CONCEPTUAL, BASIC and DETAIL DESIGN
ENGINEERING OF STYRENE PARK OFFSITE**



Document Title: Steel Structure Calculation

Document No.: EI027-DMF-VD-ST-CAL-004

Rev. R1

Page 28 of 40

1158.sdb

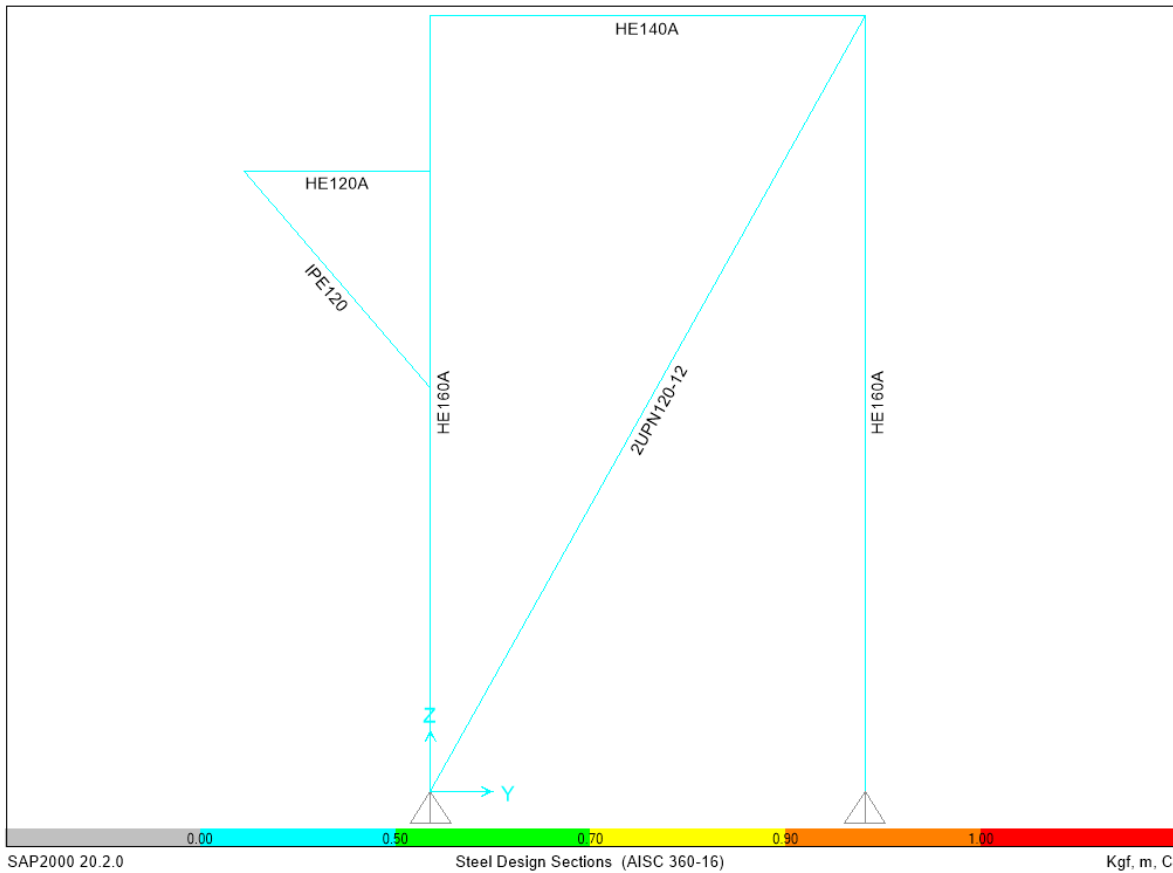

SAP2000 20.2.0

Steel Design Sections (AISC 360-16)

Kgf, m, C



Toase-eh Park Sanati Gohar Ofogh
Petrochemical Co.
**CONCEPTUAL, BASIC and DETAIL DESIGN
ENGINEERING OF STYRENE PARK OFFSITE**



Document Title: Steel Structure Calculation

Document No.: EI027-DMF-VD-ST-CAL-004

Rev. R1

Page 29 of 40

1158.sdb

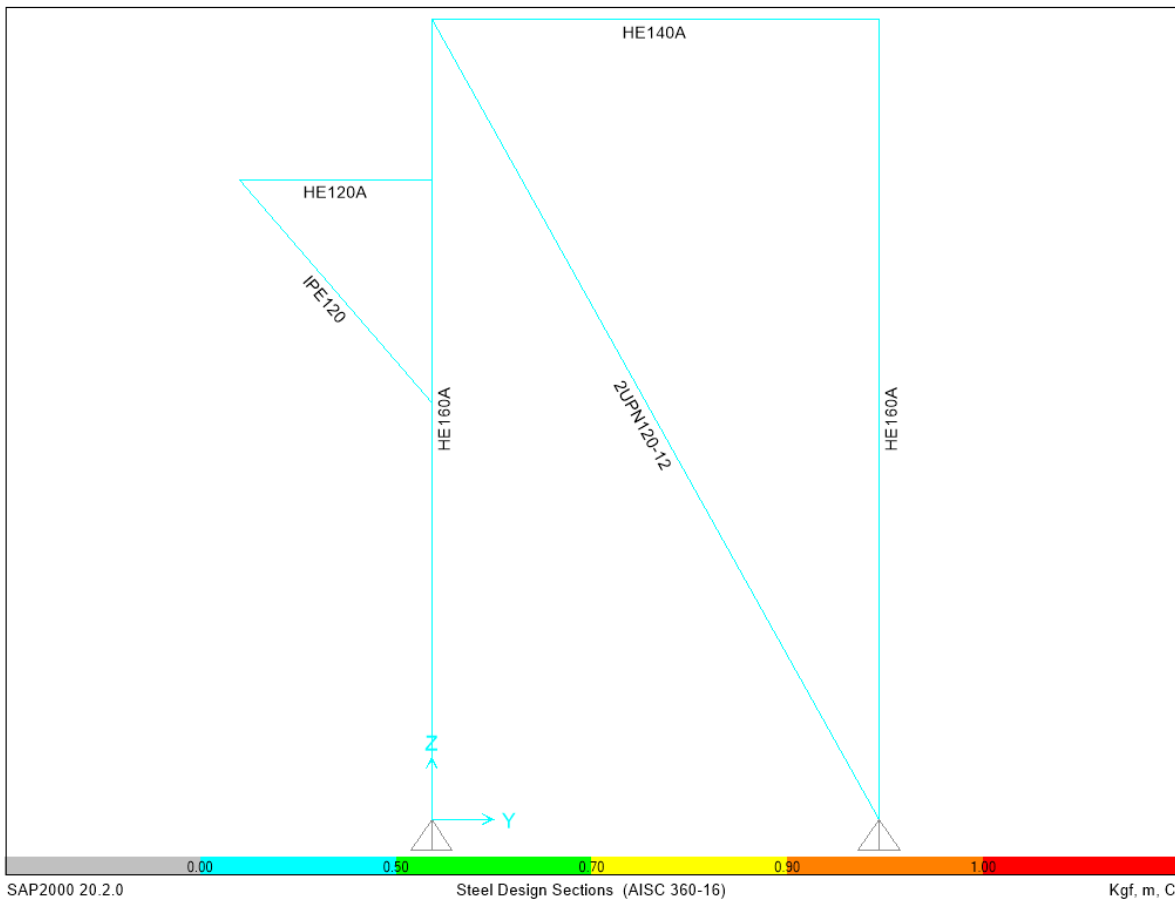



Toase-eh Park Sanati Gohar Ofogh
 Petrochemical Co.
CONCEPTUAL, BASIC and DETAIL DESIGN
ENGINEERING OF STYRENE PARK OFFSITE



Document Title: Steel Structure Calculation

Document No.: EI027-DMF-VD-ST-CAL-004

Rev. R1

Page 30 of 40



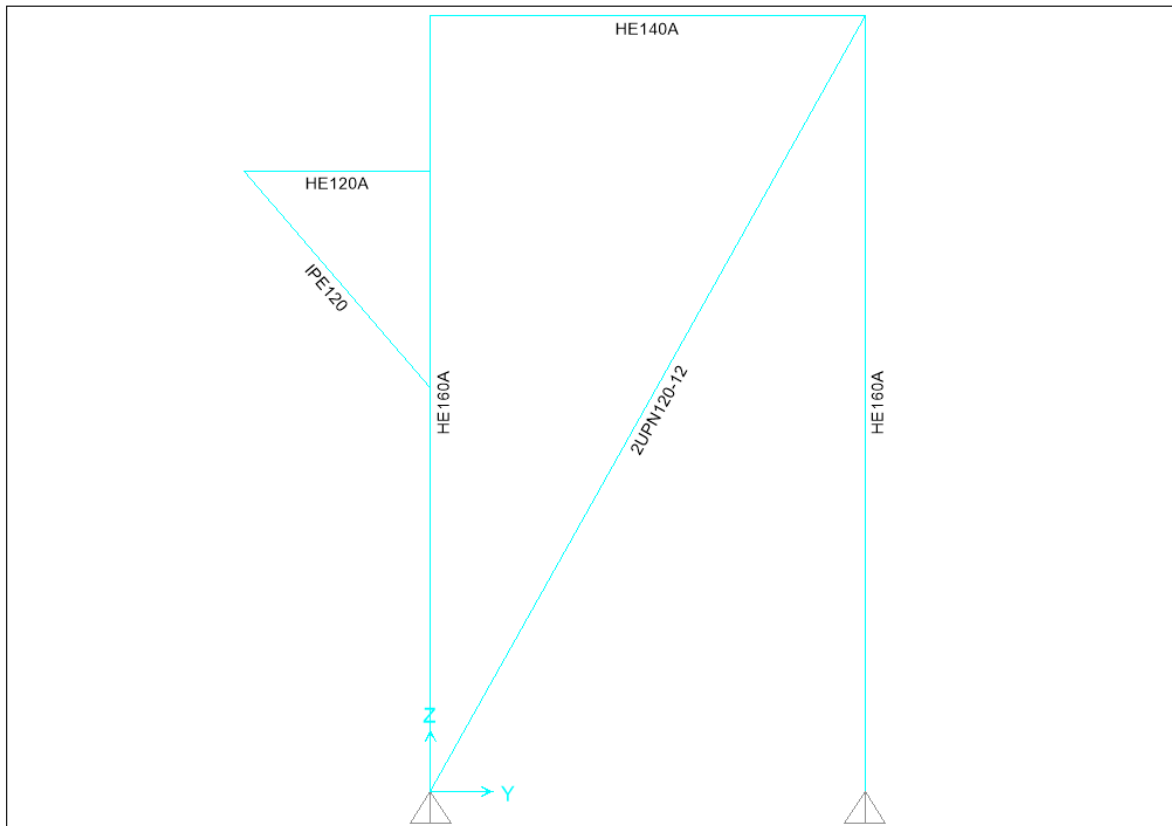

1158.sdb



SAP2000 20.2.0

Steel Design Sections (AISC 360-16)

Kgf, m, C

 	Toase-eh Park Sanati Gohar Ofogh Petrochemical Co. CONCEPTUAL, BASIC and DETAIL DESIGN ENGINEERING OF STYRENE PARK OFFSITE		  	
	Document Title: Steel Structure Calculation			
	Document No.: EI027-DMF-VD-ST-CAL-004		Rev. R1	Page 31 of 40

9. COMBINATION

Table: Combination Definitions, Part 1 of 3

Table: Combination Definitions, Part 1 of 3

ComboName	ComboType	AutoDesign	CaseType	CaseName	ScaleFactor	SteelDesign
COMB01	Linear Add	No	Linear Static	DEAD_TOTAL	1.4	Strength
COMB02	Linear Add	No	Linear Static	DEAD_TOTAL	1.2	Strength
COMB02			Linear Static	LIVE	1.6	
COMB02			Linear Static	SNOW	0.5	
COMB03	Linear Add	No	Linear Static	DEAD_TOTAL	1.2	Strength
COMB03			Linear Static	SNOW	1.6	
COMB03			Linear Static	LIVE	1	
COMB04	Linear Add	No	Linear Static	DEAD_TOTAL	1.2	Strength
COMB04			Linear Static	SNOW	1.6	
COMB04			Linear Static	WX	0.7	
COMB05	Linear Add	No	Linear Static	DEAD_TOTAL	1.2	Strength
COMB05			Linear Static	SNOW	1.6	
COMB05			Linear Static	WX	-0.7	
COMB06	Linear Add	No	Linear Static	DEAD_TOTAL	1.2	Strength
COMB06			Linear Static	SNOW	1.6	
COMB06			Linear Static	WY	0.7	
COMB07	Linear Add	No	Linear Static	DEAD_TOTAL	1.2	Strength
COMB07			Linear Static	SNOW	1.6	
COMB07			Linear Static	WY	-0.7	
COMB08	Linear Add	No	Linear Static	DEAD_TOTAL	1.2	Strength
COMB08			Linear Static	WX	1.4	
COMB08			Linear Static	LIVE	1	
COMB08			Linear Static	SNOW	0.5	
COMB09	Linear Add	No	Linear Static	DEAD_TOTAL	1.2	Strength
COMB09			Linear Static	WX	-1.4	
COMB09			Linear Static	LIVE	1	
COMB09			Linear Static	SNOW	0.5	
COMB10	Linear Add	No	Linear Static	DEAD_TOTAL	1.2	Strength
COMB10			Linear Static	WY	1.4	
COMB10			Linear Static	LIVE	1	
COMB10			Linear Static	SNOW	0.5	
COMB11	Linear Add	No	Linear Static	DEAD_TOTAL	1.2	Strength
COMB11			Linear Static	WY	-1.4	
COMB11			Linear Static	LIVE	1	
COMB11			Linear Static	SNOW	0.5	
COMB12	Linear Add	No	Linear Static	DEAD_TOTAL	0.9	Strength
COMB12			Linear Static	WX	1.4	
COMB13	Linear Add	No	Linear Static	DEAD_TOTAL	0.9	Strength
COMB13			Linear Static	WX	-1.4	
COMB14	Linear Add	No	Linear Static	DEAD_TOTAL	0.9	Strength
COMB14			Linear Static	WY	1.4	
COMB15	Linear Add	No	Linear Static	DEAD_TOTAL	0.9	Strength
COMB15			Linear Static	WY	-1.4	



**Toase-eh Park Sanati Gohar Ofogh
Petrochemical Co.
CONCEPTUAL, BASIC and DETAIL DESIGN
ENGINEERING OF STYRENE PARK OFFSITE**



Document Title: Steel Structure Calculation

Document No.: EI027-DMF-VD-ST-CAL-004

Rev. R1

Page 32 of 40

Table: Combination Definitions, Part 1 of 3

ComboName	ComboType	AutoDesign	CaseType	CaseName	ScaleFactor	SteelDesign
E_COMB01	Linear Add	No	Linear Static	DEAD_TOTAL	1.365	Strength
E_COMB01			Linear Static	EQX	1	
E_COMB01			Linear Static	LIVE	1	
E_COMB01			Linear Static	SNOW	0.2	
E_COMB02	Linear Add	No	Linear Static	DEAD_TOTAL	1.365	Strength
E_COMB02			Linear Static	EQX	-1	
E_COMB02			Linear Static	LIVE	1	
E_COMB02			Linear Static	SNOW	0.2	
E_COMB03	Linear Add	No	Linear Static	DEAD_TOTAL	1.365	Strength
E_COMB03			Linear Static	EQY	1	
E_COMB03			Linear Static	LIVE	1	
E_COMB03			Linear Static	SNOW	0.2	
E_COMB04	Linear Add	No	Linear Static	DEAD_TOTAL	1.365	Strength
E_COMB04			Linear Static	EQY	-1	
E_COMB04			Linear Static	LIVE	1	
E_COMB04			Linear Static	SNOW	0.2	
E_COMB05	Linear Add	No	Linear Static	DEAD_TOTAL	0.735	Strength
E_COMB05			Linear Static	EQX	1	
E_COMB06	Linear Add	No	Linear Static	DEAD_TOTAL	0.735	Strength
E_COMB06			Linear Static	EQX	-1	
E_COMB07	Linear Add	No	Linear Static	DEAD_TOTAL	0.735	Strength
E_COMB07			Linear Static	EQY	1	
E_COMB08	Linear Add	No	Linear Static	DEAD_TOTAL	0.735	Strength
E_COMB08			Linear Static	EQY	-1	
E_COMB09	Linear Add	No	Linear Static	DEAD_TOTAL	1.365	Strength
E_COMB09			Linear Static	EQX	1	
E_COMB09			Linear Static	LIVE	1	
E_COMB09			Linear Static	EQY	0.3	
E_COMB09			Linear Static	SNOW	0.2	
E_COMB10	Linear Add	No	Linear Static	DEAD_TOTAL	1.365	Strength
E_COMB10			Linear Static	EQX	1	
E_COMB10			Linear Static	LIVE	1	
E_COMB10			Linear Static	EQY	-0.3	
E_COMB10			Linear Static	SNOW	0.2	
E_COMB11	Linear Add	No	Linear Static	DEAD_TOTAL	1.365	Strength
E_COMB11			Linear Static	EQX	-1	
E_COMB11			Linear Static	LIVE	1	
E_COMB11			Linear Static	EQY	-0.3	
E_COMB11			Linear Static	SNOW	0.2	
E_COMB13	Linear Add	No	Linear Static	DEAD_TOTAL	1.365	Strength
E_COMB13			Linear Static	EQY	1	
E_COMB13			Linear Static	LIVE	1	
E_COMB13			Linear Static	EQX	0.3	
E_COMB13			Linear Static	SNOW	0.2	
E_COMB14	Linear Add	No	Linear Static	DEAD_TOTAL	1.365	Strength
E_COMB14			Linear Static	EQY	1	
E_COMB14			Linear Static	LIVE	1	



**Toase-eh Park Sanati Gohar Ofogh
Petrochemical Co.
CONCEPTUAL, BASIC and DETAIL DESIGN
ENGINEERING OF STYRENE PARK OFFSITE**



Document Title: Steel Structure Calculation

Document No.: EI027-DMF-VD-ST-CAL-004

Rev. R1

Page 33 of 40

Table: Combination Definitions, Part 1 of 3

ComboName	ComboType	AutoDesign	CaseType	CaseName	ScaleFactor	SteelDesign
E_COMB14			Linear Static	EQX	-0.3	
E_COMB14			Linear Static	SNOW	0.2	
E_COMB15	Linear Add	No	Linear Static	DEAD_TOTAL	1.365	Strength
E_COMB15			Linear Static	EQY	-1	
E_COMB15			Linear Static	LIVE	1	
E_COMB15			Linear Static	EQX	-0.3	
E_COMB15			Linear Static	SNOW	0.2	
E_COMB16	Linear Add	No	Linear Static	DEAD_TOTAL	1.365	Strength
E_COMB16			Linear Static	EQY	-1	
E_COMB16			Linear Static	LIVE	1	
E_COMB16			Linear Static	EQX	0.3	
E_COMB16			Linear Static	SNOW	0.2	
E_COMB17	Linear Add	No	Linear Static	DEAD_TOTAL	0.735	Strength
E_COMB17			Linear Static	EQX	1	
E_COMB17			Linear Static	EQY	0.3	
E_COMB18	Linear Add	No	Linear Static	DEAD_TOTAL	0.735	Strength
E_COMB18			Linear Static	EQX	1	
E_COMB18			Linear Static	EQY	-0.3	
E_COMB19	Linear Add	No	Linear Static	DEAD_TOTAL	0.735	Strength
E_COMB19			Linear Static	EQX	-1	
E_COMB19			Linear Static	EQY	-0.3	
E_COMB20	Linear Add	No	Linear Static	DEAD_TOTAL	0.735	Strength
E_COMB20			Linear Static	EQX	-1	
E_COMB20			Linear Static	EQY	0.3	
E_COMB21	Linear Add	No	Linear Static	DEAD_TOTAL	0.735	Strength
E_COMB21			Linear Static	EQY	1	
E_COMB21			Linear Static	EQX	0.3	
E_COMB22	Linear Add	No	Linear Static	DEAD_TOTAL	0.735	Strength
E_COMB22			Linear Static	EQY	1	
E_COMB22			Linear Static	EQX	-0.3	
E_COMB23	Linear Add	No	Linear Static	DEAD_TOTAL	0.735	Strength
E_COMB23			Linear Static	EQY	-1	
E_COMB23			Linear Static	EQX	-0.3	
E_COMB24	Linear Add	No	Linear Static	DEAD_TOTAL	0.735	Strength
E_COMB24			Linear Static	EQY	-1	
E_COMB24			Linear Static	EQX	0.3	
E_COMB12	Linear Add	No	Linear Static	DEAD_TOTAL	1.365	Strength
E_COMB12			Linear Static	EQX	-1	
E_COMB12			Linear Static	LIVE	1	
E_COMB12			Linear Static	EQY	0.3	
E_COMB12			Linear Static	SNOW	0.2	
ES_COMB01	Linear Add	No	Linear Static	DEAD_TOTAL	1.365	Strength
ES_COMB01			Linear Static	EQXO	1	
ES_COMB01			Linear Static	LIVE	1	
ES_COMB01			Linear Static	SNOW	0.2	
ES_COMB02	Linear Add	No	Linear Static	DEAD_TOTAL	1.3	Strength
ES_COMB02			Linear Static	EQXO	-1	



**Toase-eh Park Sanati Gohar Ofogh
Petrochemical Co.
CONCEPTUAL, BASIC and DETAIL DESIGN
ENGINEERING OF STYRENE PARK OFFSITE**



Document Title: Steel Structure Calculation

Document No.: EI027-DMF-VD-ST-CAL-004

Rev. R1

Page 34 of 40

Table: Combination Definitions, Part 1 of 3

ComboName	ComboType	AutoDesign	CaseType	CaseName	ScaleFactor	SteelDesign
ES_COMB02			Linear Static	LIVE	1	
ES_COMB02			Linear Static	SNOW	0.2	
ES_COMB03	Linear Add	No	Linear Static	DEAD_TOTAL	1.365	Strength
ES_COMB03			Linear Static	EQYO	1	
ES_COMB03			Linear Static	LIVE	1	
ES_COMB03			Linear Static	SNOW	0.2	
ES_COMB04	Linear Add	No	Linear Static	DEAD_TOTAL	1.365	Strength
ES_COMB04			Linear Static	EQYO	-1	
ES_COMB04			Linear Static	LIVE	1	
ES_COMB04			Linear Static	SNOW	0.2	
ES_COMB05	Linear Add	No	Linear Static	DEAD_TOTAL	0.735	Strength
ES_COMB05			Linear Static	EQXO	1	
ES_COMB06	Linear Add	No	Linear Static	DEAD_TOTAL	0.735	Strength
ES_COMB06			Linear Static	EQXO	-1	
ES_COMB07	Linear Add	No	Linear Static	DEAD_TOTAL	0.735	Strength
ES_COMB07			Linear Static	EQYO	1	
ES_COMB08	Linear Add	No	Linear Static	DEAD_TOTAL	0.735	Strength
ES_COMB08			Linear Static	EQYO	-1	
ES_COMB09	Linear Add	No	Linear Static	DEAD_TOTAL	1.365	Strength
ES_COMB09			Linear Static	EQXO	1	
ES_COMB09			Linear Static	LIVE	1	
ES_COMB09			Linear Static	EQYO	0.3	
ES_COMB09			Linear Static	SNOW	0.2	
ES_COMB10	Linear Add	No	Linear Static	DEAD_TOTAL	1.365	Strength
ES_COMB10			Linear Static	EQXO	1	
ES_COMB10			Linear Static	LIVE	1	
ES_COMB10			Linear Static	EQYO	-0.3	
ES_COMB10			Linear Static	SNOW	0.2	
ES_COMB11	Linear Add	No	Linear Static	DEAD_TOTAL	1.365	Strength
ES_COMB11			Linear Static	EQXO	-1	
ES_COMB11			Linear Static	LIVE	1	
ES_COMB11			Linear Static	EQYO	-0.3	
ES_COMB11			Linear Static	SNOW	0.2	
ES_COMB13	Linear Add	No	Linear Static	DEAD_TOTAL	1.365	Strength
ES_COMB13			Linear Static	EQYO	1	
ES_COMB13			Linear Static	LIVE	1	
ES_COMB13			Linear Static	EQXO	0.3	
ES_COMB13			Linear Static	SNOW	0.2	
ES_COMB14	Linear Add	No	Linear Static	DEAD_TOTAL	1.365	Strength
ES_COMB14			Linear Static	EQYO	1	
ES_COMB14			Linear Static	LIVE	1	
ES_COMB14			Linear Static	EQXO	-0.3	
ES_COMB14			Linear Static	SNOW	0.2	
ES_COMB15	Linear Add	No	Linear Static	DEAD_TOTAL	1.365	Strength
ES_COMB15			Linear Static	EQYO	-1	
ES_COMB15			Linear Static	LIVE	1	
ES_COMB15			Linear Static	EQXO	-0.3	



Toase-eh Park Sanati Gohar Ofogh
Petrochemical Co.
**CONCEPTUAL, BASIC and DETAIL DESIGN
ENGINEERING OF STYRENE PARK OFFSITE**



Document Title: Steel Structure Calculation

Document No.: EI027-DMF-VD-ST-CAL-004

Rev. R1

Page 35 of 40

Table: Combination Definitions, Part 1 of 3

ComboName	ComboType	AutoDesign	CaseType	CaseName	ScaleFactor	SteelDesign
ES_COMB15			Linear Static	SNOW	0.2	
ES_COMB16	Linear Add	No	Linear Static	DEAD_TOTAL	1.365	Strength
ES_COMB16			Linear Static	EQYO	-1	
ES_COMB16			Linear Static	LIVE	1	
ES_COMB16			Linear Static	EQXO	0.3	
ES_COMB16			Linear Static	SNOW	0.2	
ES_COMB17	Linear Add	No	Linear Static	DEAD_TOTAL	0.735	Strength
ES_COMB17			Linear Static	EQXO	1	
ES_COMB17			Linear Static	EQYO	0.3	
ES_COMB18	Linear Add	No	Linear Static	DEAD_TOTAL	0.735	Strength
ES_COMB18			Linear Static	EQXO	1	
ES_COMB18			Linear Static	EQYO	-0.3	
ES_COMB19	Linear Add	No	Linear Static	DEAD_TOTAL	0.735	Strength
ES_COMB19			Linear Static	EQXO	-1	
ES_COMB19			Linear Static	EQYO	-0.3	
ES_COMB20	Linear Add	No	Linear Static	DEAD_TOTAL	0.735	Strength
ES_COMB20			Linear Static	EQXO	-1	
ES_COMB20			Linear Static	EQYO	0.3	
ES_COMB21	Linear Add	No	Linear Static	DEAD_TOTAL	0.735	Strength
ES_COMB21			Linear Static	EQYO	1	
ES_COMB21			Linear Static	EQXO	0.3	
ES_COMB22	Linear Add	No	Linear Static	DEAD_TOTAL	0.735	Strength
ES_COMB22			Linear Static	EQYO	1	
ES_COMB22			Linear Static	EQXO	-0.3	
ES_COMB23	Linear Add	No	Linear Static	DEAD_TOTAL	0.735	Strength
ES_COMB23			Linear Static	EQYO	-1	
ES_COMB23			Linear Static	EQXO	-0.3	
ES_COMB24	Linear Add	No	Linear Static	DEAD_TOTAL	0.735	Strength
ES_COMB24			Linear Static	EQYO	-1	
ES_COMB24			Linear Static	EQXO	0.3	
ES_COMB12	Linear Add	No	Linear Static	DEAD_TOTAL	1.365	Strength
ES_COMB12			Linear Static	EQXO	-1	
ES_COMB12			Linear Static	LIVE	1	
ES_COMB12			Linear Static	EQYO	0.3	
ES_COMB12			Linear Static	SNOW	0.2	
DEF_COMB1	Linear Add	No	Linear Static	DEAD_TOTAL	1	Strength
DEF_COMB2	Linear Add	No	Linear Static	LIVE	1	Strength
DEF_COMB3	Linear Add	No	Linear Static	DEAD_TOTAL	1	Strength
DEF_COMB3			Linear Static	LIVE	1	
DEF_COMB4	Linear Add	No	Linear Static	DEAD_TOTAL	1	Strength
DEF_COMB4			Linear Static	SNOW	0.55	
COMB00	Linear Add	No	Linear Static	DEAD_TOTAL	1.2	Strength



**Toase-eh Park Sanati Gohar Ofogh
Petrochemical Co.
CONCEPTUAL, BASIC and DETAIL DESIGN
ENGINEERING OF STYRENE PARK OFFSITE**



Document Title: Steel Structure Calculation

Document No.: EI027-DMF-VD-ST-CAL-004

Rev. R1

Page 36 of 40

10. JOINT REACTION

Table: Joint Reactions

Table: Joint Reactions

Joint	OutputCase	CaseType	F1	F2	F3	M1	M2	M3
			Kgf	Kgf	Kgf	Kgf-cm	Kgf-cm	Kgf-cm
A-1	DEAD_S	LinStatic	16.65	-45	861.98	0	0	0
A-1	DEAD	LinStatic	49.34	-158.83	1640.14	0	0	0
A-1	DEAD_OP	LinStatic	4.08	-14.37	92.37	0	0	0
A-1	DEAD_N	LinStatic	-1631.93	429.16	-2881.5	0	0	0
A-1	LIVE	LinStatic	3.34	25.54	1383.73	0	0	0
A-1	WX	LinStatic	31.57	329.34	-352.72	0	0	0
A-1	WY	LinStatic	-387.76	93.94	-669.09	0	0	0
A-1	SNOW	LinStatic	9.74	-24.99	547.6	0	0	0
A-1	EQX	LinStatic	106.43	1146.34	-1764.17	0	0	0
A-1	EQY	LinStatic	-1561.76	337	-3289.21	0	0	0
A-1	EQXO	LinStatic	210.24	2295.43	-3529.78	0	0	0
A-1	EQYO	LinStatic	-3123.79	673.24	-6571.39	0	0	0
A-2	DEAD_S	LinStatic	-20.6	1.599E-13	380.54	0	0	0
A-2	DEAD	LinStatic	-33.06	-2.89E-06	811.07	0	0	0
A-2	DEAD_OP	LinStatic	-0.21	-3.963E-07	55.27	0	0	0
A-2	DEAD_N	LinStatic	-10.59	-1.13	-378.95	0	0	0
A-2	LIVE	LinStatic	-76.47	6.353E-13	402.18	0	0	0
A-2	WX	LinStatic	1.165E-12	49.87	8.288E-13	0	0	0
A-2	WY	LinStatic	-54.91	-1.269E-13	-353.83	0	0	0
A-2	SNOW	LinStatic	-19.58	-8.653E-07	221.21	0	0	0
A-2	EQX	LinStatic	0.004107	45.8	0.09216	0	0	0
A-2	EQY	LinStatic	-48.82	-0.38	-1465.12	0	0	0
A-2	EQXO	LinStatic	0.00889	92.7	0.18	0	0	0
A-2	EQYO	LinStatic	-98.54	-0.78	-2927.34	0	0	0
A-3	DEAD_S	LinStatic	16.65	45	861.98	0	0	0
A-3	DEAD	LinStatic	49.34	158.83	1640.17	0	0	0
A-3	DEAD_OP	LinStatic	4.08	14.37	92.37	0	0	0
A-3	DEAD_N	LinStatic	39.17	235.02	482.86	0	0	0
A-3	LIVE	LinStatic	3.34	-25.54	1383.73	0	0	0
A-3	WX	LinStatic	-31.57	329.34	352.72	0	0	0
A-3	WY	LinStatic	-387.76	-93.94	-669.09	0	0	0
A-3	SNOW	LinStatic	9.74	24.99	547.61	0	0	0
A-3	EQX	LinStatic	-106.49	1146.49	1764.07	0	0	0
A-3	EQY	LinStatic	-1071.77	-428.48	-2570.23	0	0	0
A-3	EQXO	LinStatic	-210.36	2295.75	3529.6	0	0	0
A-3	EQYO	LinStatic	-2144	-856.2	-5134.3	0	0	0
B-1	DEAD_S	LinStatic	34.11	-1.44	482.68	0	0	0
B-1	DEAD	LinStatic	174.23	-2.24	983.92	0	0	0
B-1	DEAD_OP	LinStatic	16.3	0.03128	81.45	0	0	0
B-1	DEAD_N	LinStatic	-670.87	1.33	2555.04	0	0	0
B-1	LIVE	LinStatic	-43.74	-6.51	64.14	0	0	0
B-1	WX	LinStatic	-255.25	0.99	-374.63	0	0	0
B-1	WY	LinStatic	-1.33	-70.96	504.74	0	0	0
B-1	SNOW	LinStatic	24.65	-1.56	193.87	0	0	0



**Toase-eh Park Sanati Gohar Ofogh
Petrochemical Co.
CONCEPTUAL, BASIC and DETAIL DESIGN
ENGINEERING OF STYRENE PARK OFFSITE**



Document Title: Steel Structure Calculation

Document No.: EI027-DMF-VD-ST-CAL-004

Rev. R1

Page 37 of 40

Table: Joint Reactions

Joint	OutputCase	CaseType	F1	F2	F3	M1	M2	M3
			Kgf	Kgf	Kgf	Kgf-cm	Kgf-cm	Kgf-cm
B-1	EQX	LinStatic	-985.73	4.1	-1834.5	0	0	0
B-1	EQY	LinStatic	-51.12	-28.6	2619.38	0	0	0
B-1	EQXO	LinStatic	-1968.03	8.18	-3658.39	0	0	0
B-1	EQYO	LinStatic	-102.38	-57.85	5233.15	0	0	0
B-2	DEAD_S	LinStatic	-3.76E-15	-9.82	342.79	0	0	0
B-2	DEAD	LinStatic	-1.168E-10	-61.15	847.79	0	0	0
B-2	DEAD_OP	LinStatic	-1.602E-11	-8.01	77.09	0	0	0
B-2	DEAD_N	LinStatic	-0.0003857	-403.24	720.08	0	0	0
B-2	LIVE	LinStatic	8.844E-15	82.81	-147.91	0	0	0
B-2	WX	LinStatic	-56.07	3.583E-12	-6.399E-12	0	0	0
B-2	WY	LinStatic	-8.004E-14	-439.42	682.53	0	0	0
B-2	SNOW	LinStatic	-3.498E-11	3.21	131.34	0	0	0
B-2	EQX	LinStatic	0.02819	0.04229	-0.07544	0	0	0
B-2	EQY	LinStatic	0.006383	-1570.51	2804.88	0	0	0
B-2	EQXO	LinStatic	-0.2	0.08416	-0.15	0	0	0
B-2	EQYO	LinStatic	0.0007535	-3138.25	5603.81	0	0	0
B-3	DEAD_S	LinStatic	-34.11	-1.44	482.68	0	0	0
B-3	DEAD	LinStatic	-174.23	-2.24	983.9	0	0	0
B-3	DEAD_OP	LinStatic	-16.3	0.03128	81.45	0	0	0
B-3	DEAD_N	LinStatic	-670.07	1.26	1104.47	0	0	0
B-3	LIVE	LinStatic	43.74	-6.51	64.14	0	0	0
B-3	WX	LinStatic	-255.25	-0.99	374.63	0	0	0
B-3	WY	LinStatic	1.33	-70.96	504.74	0	0	0
B-3	SNOW	LinStatic	-24.65	-1.56	193.87	0	0	0
B-3	EQX	LinStatic	-985.8	-4.09	1834.58	0	0	0
B-3	EQY	LinStatic	-40.75	-28.68	1900.29	0	0	0
B-3	EQXO	LinStatic	-1968.16	-8.15	3658.54	0	0	0
B-3	EQYO	LinStatic	-81.36	-57.83	3796.07	0	0	0

11. Steel Design

Table: Steel Design 1 - Summary Data - AISC 360-16, Part 1 of 2

Table: Steel Design 1 - Summary Data - AISC 360-16, Part 1 of 2

Frame	DesignSect	DesignType	Status	Ratio	RatioType
99	HE160A	Column	No Messages	0.253046	PMM
101	HE160A	Column	No Messages	0.054665	PMM
102	HE160A	Column	No Messages	0.040064	PMM
103	HE160A	Column	No Messages	0.261971	PMM
104	HE160A	Column	No Messages	0.406105	PMM
105	HE140A	Beam	No Messages	0.162303	PMM
106	HE140A	Beam	No Messages	0.131533	PMM
107	HE140A	Beam	No Messages	0.211858	PMM
108	HE140A	Beam	No Messages	0.251346	PMM
109	HE140A	Beam	No Messages	0.171418	PMM



**Toase-eh Park Sanati Gohar Ofogh
Petrochemical Co.
CONCEPTUAL, BASIC and DETAIL DESIGN
ENGINEERING OF STYRENE PARK OFFSITE**



Document Title: Steel Structure Calculation

Document No.: EI027-DMF-VD-ST-CAL-004

Rev. R1

Page 38 of 40

Table: Steel Design 1 - Summary Data - AISC 360-16, Part 1 of 2

Frame	DesignSect	DesignType	Status	Ratio	RatioType
110	HE140A	Beam	No Messages	0.146359	PMM
111	HE140A	Beam	No Messages	0.273511	PMM
112	2UPN120-12	Brace	No Messages	0.375081	PMM
113	2UPN120-12	Brace	No Messages	0.19283	PMM
114	2UPN120-12	Brace	No Messages	0.182065	PMM
115	2UPN120-12	Brace	No Messages	0.451008	PMM
116	2UPN120-12	Brace	No Messages	0.20756	PMM
117	2UPN120-12	Brace	No Messages	0.417087	PMM
118	2UPN120-12	Brace	No Messages	0.171919	PMM
119	HE120A	Beam	No Messages	0.13618	PMM
120	IPE120	Brace	No Messages	0.064215	PMM
121	HE120A	Beam	No Messages	0.137819	PMM
122	IPE120	Brace	No Messages	0.064216	PMM
123	HE120A	Beam	No Messages	0.139296	PMM
124	IPE120	Brace	No Messages	0.064217	PMM
125	HE120A	Beam	No Messages	0.139809	PMM
126	IPE120	Brace	No Messages	0.064216	PMM
127	UPN140	Beam	No Messages	0.12311	PMM
128	UPN140	Beam	No Messages	0.132319	PMM
129	L60X6	Beam	No Messages	0.122285	PMM
130	L60X6	Beam	No Messages	0.122288	PMM
131	UPN140	Beam	No Messages	0.12312	PMM
132	UPN140	Beam	No Messages	0.132382	PMM
133	L60X6	Beam	No Messages	0.122283	PMM
134	L60X6	Beam	No Messages	0.122287	PMM
135	L60X6	Beam	No Messages	0.021851	PMM
136	L60X6	Beam	No Messages	0.021851	PMM
137	HE120A	Beam	No Messages	0.037961	PMM
138	HE120A	Beam	No Messages	0.040573	PMM
139	IPE120	Beam	No Messages	0.017324	PMM
140	IPE120	Beam	No Messages	0.02021	PMM
141	IPE120	Beam	No Messages	0.022546	PMM
142	IPE120	Beam	No Messages	0.014772	PMM
143	IPE120	Beam	No Messages	0.031597	PMM
144	IPE120	Beam	No Messages	0.025976	PMM
145	IPE120	Beam	No Messages	0.021312	PMM
146	IPE120	Beam	No Messages	0.036496	PMM
147	HE160A	Column	No Messages	0.275513	PMM

Table: Steel Design 1 - Summary Data - AISC 360-16, Part 2 of 2

Table: Steel Design 1 - Summary Data - AISC 360-16, Part 2 of 2

Frame	Combo	Location m	ErrMsg	WarnMsg
99	ES_COMB11	2.6	No Messages	No Messages
101	ES_COMB16	0	No Messages	No Messages



**Toase-eh Park Sanati Gohar Ofogh
Petrochemical Co.
CONCEPTUAL, BASIC and DETAIL DESIGN
ENGINEERING OF STYRENE PARK OFFSITE**



Document Title: Steel Structure Calculation





Document No.: EI027-DMF-VD-ST-CAL-004

Rev. R1

Page 39 of 40

Table: Steel Design 1 - Summary Data - AISC 360-16, Part 2 of 2

Frame	Combo	Location m	ErrMsg	WarnMsg
102	COMB08	2.5	No Messages	No Messages
103	ES_COMB10	2.6	No Messages	No Messages
104	ES_COMB13	2.6	No Messages	No Messages
105	ES_COMB16	1.8	No Messages	No Messages
106	ES_COMB11	1.85	No Messages	No Messages
107	ES_COMB09	1	No Messages	No Messages
108	ES_COMB12	1	No Messages	No Messages
109	ES_COMB12	1.85	No Messages	No Messages
110	ES_COMB10	1	No Messages	No Messages
111	ES_COMB14	1.8	No Messages	No Messages
112	ES_COMB10	2.87761	No Messages	No Messages
113	ES_COMB11	2.87761	No Messages	No Messages
114	ES_COMB13	2.86531	No Messages	No Messages
115	ES_COMB14	2.86531	No Messages	No Messages
116	ES_COMB16	0	No Messages	No Messages
117	ES_COMB09	2.87761	No Messages	No Messages
118	ES_COMB11	2.87761	No Messages	No Messages
119	ES_COMB15	0.65	No Messages	No Messages
120	COMB10	0.98995	No Messages	No Messages
121	ES_COMB13	0.65	No Messages	No Messages
122	COMB10	0.98995	No Messages	No Messages
123	ES_COMB14	0.65	No Messages	No Messages
124	COMB11	0.98995	No Messages	No Messages
125	ES_COMB16	0.65	No Messages	No Messages
126	COMB11	0.98995	No Messages	No Messages
127	COMB02	1.4	No Messages	No Messages
128	COMB02	1.4	No Messages	No Messages
129	ES_COMB13	0.79412	No Messages	No Messages
130	ES_COMB16	0.79412	No Messages	No Messages
131	COMB02	1.4	No Messages	No Messages
132	COMB02	1.4	No Messages	No Messages
133	ES_COMB14	0.79412	No Messages	No Messages
134	ES_COMB15	0.79412	No Messages	No Messages
135	ES_COMB09	0.375	No Messages	No Messages
136	ES_COMB12	0.375	No Messages	No Messages
137	COMB11	1.425	No Messages	No Messages
138	COMB11	1.425	No Messages	No Messages
139	ES_COMB10	0.4714	No Messages	No Messages
140	ES_COMB11	0.4714	No Messages	No Messages
141	ES_COMB09	0.94281	No Messages	No Messages
142	ES_COMB12	0.4714	No Messages	No Messages
143	ES_COMB12	0.4714	No Messages	No Messages
144	ES_COMB09	0.94281	No Messages	No Messages
145	ES_COMB11	0.4714	No Messages	No Messages
146	ES_COMB10	0.4714	No Messages	No Messages
147	ES_COMB14	2.6	No Messages	No Messages

 	Toase-e Park Sanati Gohar Ofogh Petrochemical Co. CONCEPTUAL, BASIC and DETAIL DESIGN ENGINEERING OF STYRENE PARK OFFSITE	  
	Document Title: Steel Structure Calculation	
	Document No.: EI027-DMF-VD-ST-CAL-004	Rev. R1 Page 40 of 40

12. Story Drift & Deflection Control

According to ASCE7-16 Table 12.12-1 :

Allowable Story Drift For I & II Stroy = 0.025h

$$\rightarrow Cd \cdot \Delta eu < 0.025 \cdot h \rightarrow \Delta eu < 0.025 \cdot 5000 / 3.5 \rightarrow \Delta eu < 35.7 \text{ mm}$$

$$Cd = 3.5$$

Maximum Drift at 160 joint in Direction x = 1.61 mm < 35.7 mm

..... (OK)

Maximum Drift at 160 joint in Direction y = 2.2 mm < 35.7 mm

..... (OK)

DEFLECTION CONTROL:

Main Beam: Dmaximum = 0.289 cm < L/500 (L=280)

Walkway Beam: Dmaximum = 0.16 cm < L/300 (L=400)