

Drawing List

No.	Drawing Title
1	DRAWING LIST 1
2	Outline Drawing
3	Inside Layout Drawing
4	POWER DISTRIBUTION DRAWING 1
5	POWER DISTRIBUTION DRAWING 2
6	POWER DISTRIBUTION DRAWING 3
7	POWER DISTRIBUTION DRAWING 4
8	PLC CONFIGURATION DRAWING 1
9	PLC I/O DRAWING 1
10	PLC I/O DRAWING 2
11	PLC I/O DRAWING 3
12	PLC I/O DRAWING 4
13	PLC I/O DRAWING 5
14	PLC I/O DRAWING 6
15	PLC I/O DRAWING 7
16	INTERNAL CIRCUIT DIAGRAM 1
17	INTERNAL CIRCUIT DIAGRAM 2
18	INTERNAL CIRCUIT DIAGRAM 3
19	INTERNAL CIRCUIT DIAGRAM 4
20	INTERNAL CIRCUIT DIAGRAM 5
21	INTERNAL CIRCUIT DIAGRAM 6
22	INTERNAL CIRCUIT DIAGRAM 7
23	INTERNAL CIRCUIT DIAGRAM 8
24	INTERNAL CIRCUIT DIAGRAM 9
25	INTERNAL CIRCUIT DIAGRAM 10
26	INTERNAL CIRCUIT DIAGRAM 11
27	INTERNAL CIRCUIT DIAGRAM 12
28	INTERNAL CIRCUIT DIAGRAM 13
29	TERMINAL ARRANGEMENT AND CABLE CONNECTION DIAGRAM 1
30	TERMINAL ARRANGEMENT AND CABLE CONNECTION DIAGRAM 2

No.	Drawing Title
31	TERMINAL ARRANGEMENT AND CABLE CONNECTION DIAGRAM 3
32	TERMINAL ARRANGEMENT AND CABLE CONNECTION DIAGRAM 4
33	TERMINAL ARRANGEMENT AND CABLE CONNECTION DIAGRAM 5
34	TERMINAL ARRANGEMENT AND CABLE CONNECTION DIAGRAM 6
35	TERMINAL ARRANGEMENT AND CABLE CONNECTION DIAGRAM 7
36	TERMINAL ARRANGEMENT AND CABLE CONNECTION DIAGRAM 8
37	TERMINAL ARRANGEMENT AND CABLE CONNECTION DIAGRAM 9
38	TERMINAL ARRANGEMENT AND CABLE CONNECTION DIAGRAM 10
39	INTERNAL PARTS LIST 1
40	INTERNAL PARTS LIST 2
41	
42	
43	
44	
45	
46	
47	
48	
49	
50	
51	
52	
53	
54	
55	
56	
57	
58	
59	
60	

WIRE COLOR CODE (IEC 60757)

BK : BLACK
 BN : BROWN
 RD : RED
 OG : ORANGE
 GN : GREEN
 BU : DARK BLUE
 LB : LIGHT BLUE
 GY : GREY
 WH : WHITE
 GNYE : GREEN AND YELLOW
 SH : SCREENING METAL

IDENTIFICATION OF WIRING

AC POWER CIRCUITS: BROWN (L) AND LIGHT BLUE (N)
 AC CONTROL CIRCUITS: BROWN (L) AND LIGHT BLUE (N)
 DC POWER CIRCUITS: DARK BLUE
 DC CONTROL CIRCUITS: DARK BLUE
 DRY CONTACT CIRCUITS: ORANGE
 PROTECTIVE EARTH: YELLOW/GREEN
 INSTRUMENT EARTH: GREEN
 INTRINSIC SAFETY EARCH: GREEN

MINIMUM CROSS SECTION OF CABLE AND WIRES

POWER CIRCUITS : $\leq 4.0\text{mm}^2$
 CONTROL CIRCUITS (DRY CONTACT) : 1.0mm^2
 CONTROL CIRCUITS : 1.0mm^2
 PLC/I/O CIRCUITS: 0.75mm^2
 ANALOG CIRCUITS: 0.75mm^2

WIRE TERMINAL & MARKER

ALL WIRING SHALL USE CRIMP TERMINALS
 THE SHAPE OF THE CRIMP TERMINAL SHALL BE SUITABLE FOR TERMINAL
 NO MORE THAN TWO WIRES CONNECTED TO ANY ONE TERMINAL
 ALL CONTROL CIRCUITS SHALL BE MARKED ON EACH END
 WITH PERMANENTLY-EMBOSSED WIRE MARKERS AS FOLLOWS:
 WHITE HEAT SHRINK TYPE WITH BLACK LETTERS

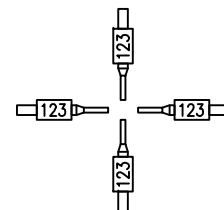

REV.	ISSUE DATE	DESCRIPTION	PREPARED	CHECKED	APPROVED	COMPANY
0	6/01/25	First Issue	SV	-	-	-
CLIENT:			CONSULTING ENGINEER:			
VENDOR:						
PROJECT: PR200						
DRAWING TITLE: PLC Wiring and Layout Drawing						
DRAWING NO. E1027-HSE-VD-IN-DIG-008			REV. RO	SIZE A3	SCALE NA	SHEET 1 / 40

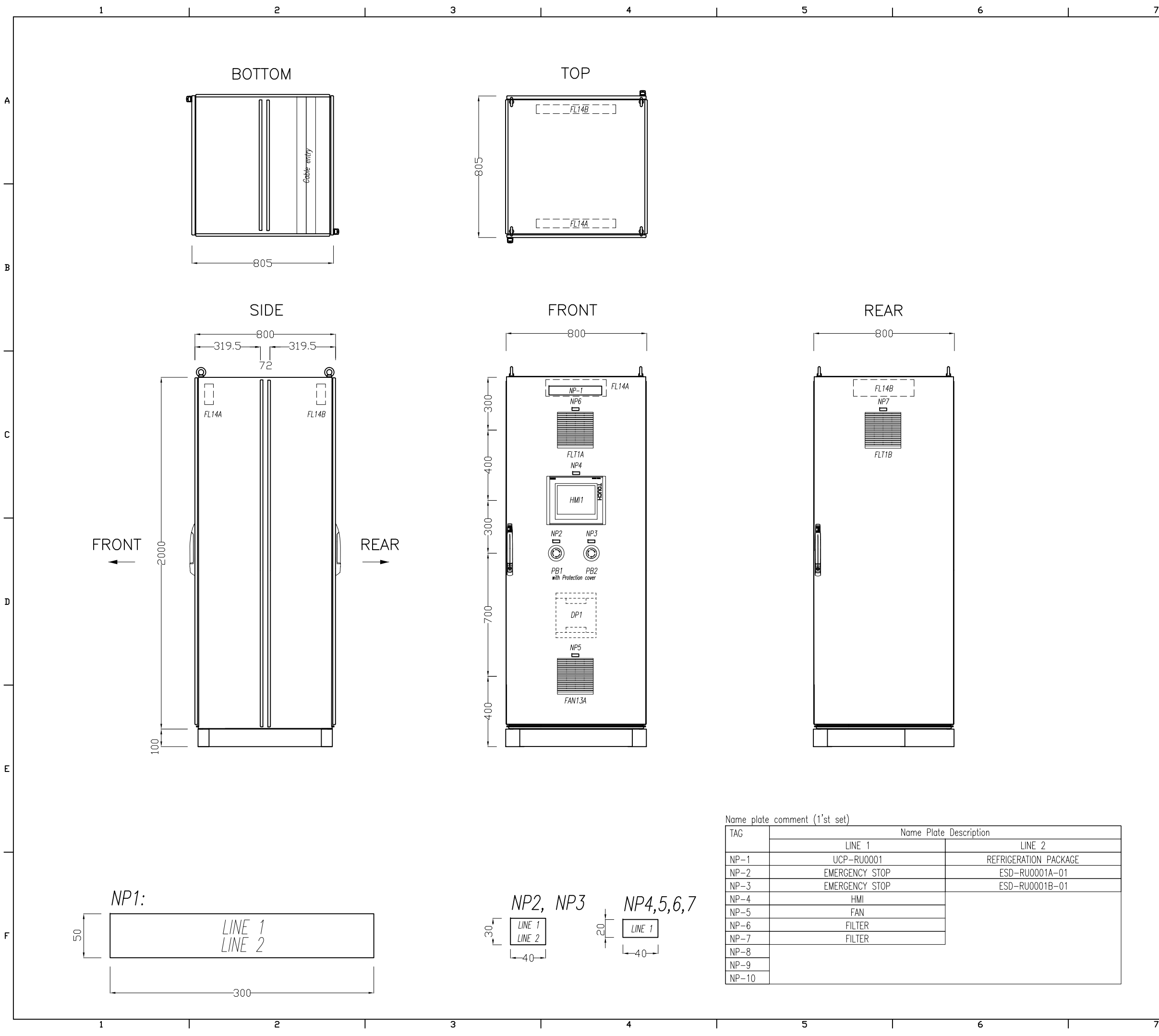

GENERAL NOTES

ENCLOSURE

MODEL: RITTAL VX 8808.000/ VX 8108.245
 2nd mounting plate VX 5051.043 + 5051.045
 BASE: RITTAL VX 8660.003/ VX 8660.034
 Door Lock: RITTAL VX 8618.200/ TS 8611.180
 COLOR: CABINET: RAL 7035
 BASE: RAL 7022
 PRO.CLASS: IP54
 CABLE ENTRY: VX 8618.8111 x1 (REAR / Bottom)

FILTER: SK 3239.300 x2 (FLT1A/FLT1B)
 FAN: SK 3239.700 x1 (FAN13A)
 DOC. POCKET: SZ 2514.000 (A4) x1 (DP1)
 PANEL LIGHT: SZ 2500.310 x2 (FL14A/FL14B)

NAME PLATE

MATERIAL: LAMINATED PLASTIC
 PLATE COLOR: WHITE
 LETTER COLOR: BLACK
 FIXING: SELF ADHESIVE

REV.	ISSUE DATE	DESCRIPTION	PREPARED	CHECKED	APPROVED	COMPANY
0	6/01/25	First issue	SV	-	-	-

CLIENT: _____ CONSULTING ENGINEER: _____

VENDOR: _____

PROJECT: **PR200**

DRAWING TITLE: **PLC Wiring and Layout Drawing**

DRAWING NO.	REV.	SIZE	SCALE	SHEET
E1027-HSE-VD-IN-DIG-008	RO	A3	NA	2 / 40

Name plate comment (1'st set)

TAG	Name Plate Description	
	LINE 1	LINE 2
NP-1	UCP-RU0001	REFRIGERATION PACKAGE
NP-2	EMERGENCY STOP	ESD-RU0001A-01
NP-3	EMERGENCY STOP	ESD-RU0001B-01
NP-4	HMI	
NP-5	FAN	
NP-6	FILTER	
NP-7	FILTER	
NP-8		
NP-9		
NP-10		

FRONT

REAR

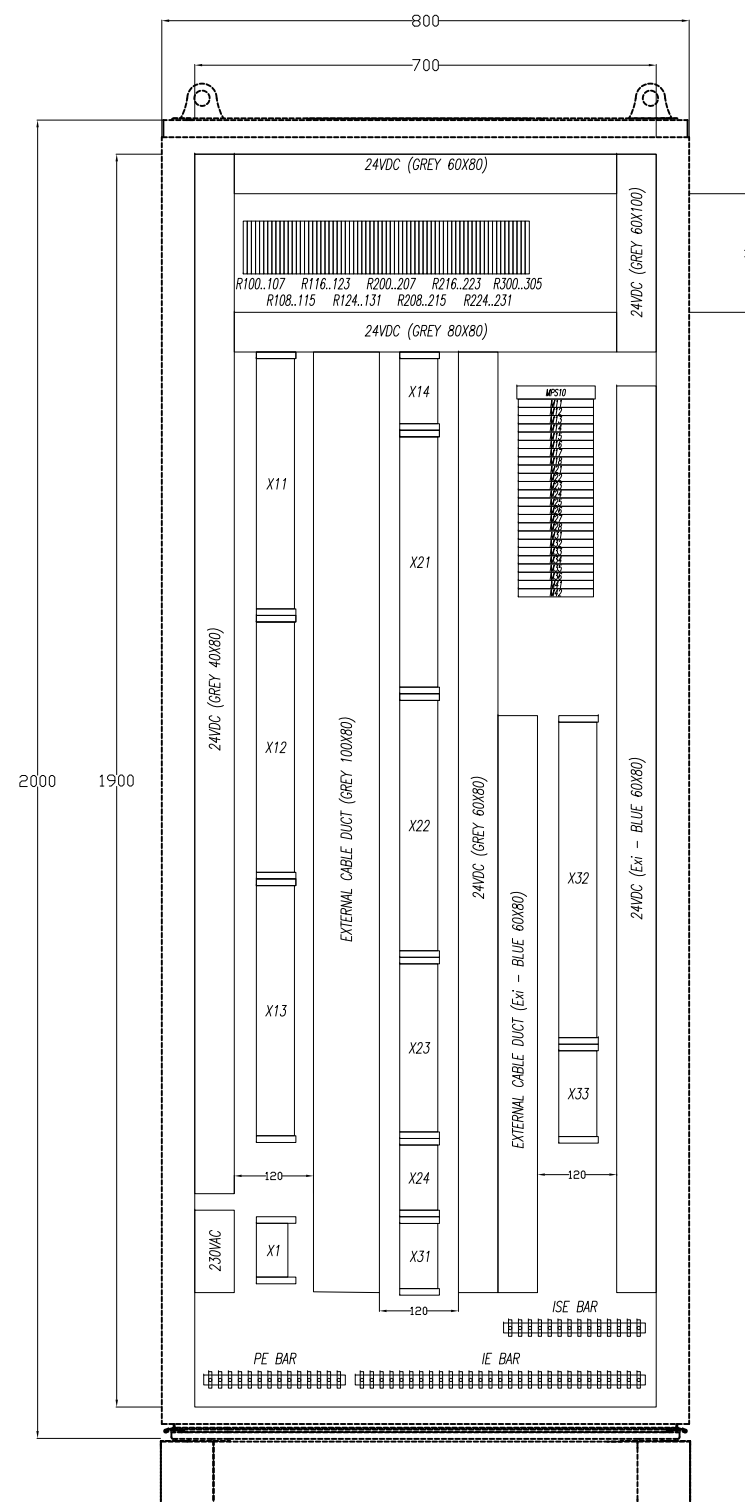
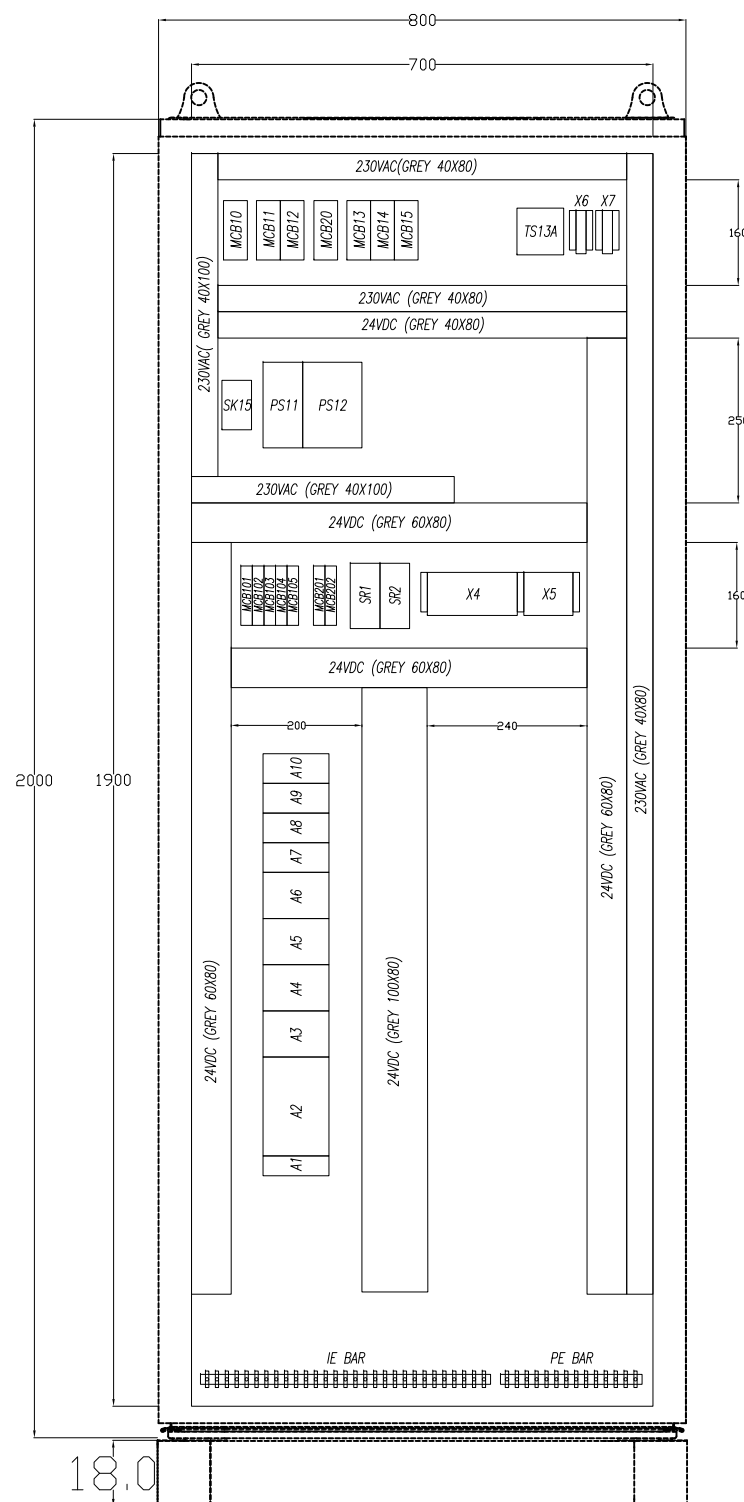

NOTE : ALL PARTS (EXCEPT DUCTS & EARTH BARS) MOUNTED ON NS35 DIN RAIL

REV.	ISSUE DATE	DESCRIPTION	PREPARED	CHECKED	APPROVED	COMPANY
0	6/01/25	First Issue	SV	-	-	-
CLIENT:			CONSULTING ENGINEER:			
VENDOR:						
PROJECT: PR200						
DRAWING TITLE: PLC Wiring and Layout Drawing						
DRAWING NO. E1027-HSE-VD-IN-DIG-008			REV. R0	SIZE A3	SCALE NA	SHEET 3 / 40

GENERAL NOTES

WIRE COLOR CODE (IEC 60757)

- BK : BLACK
- BN : BROWN
- RD : RED
- OG : ORANGE
- GN : GREEN
- BU : DARK BLUE
- LB : LIGHT BLUE
- GY : GREY
- WH : WHITE
- GNYE : GREEN AND YELLOW
- SH : SCREENING METAL

WIRE MARKER

White heat shrink type with Black letter

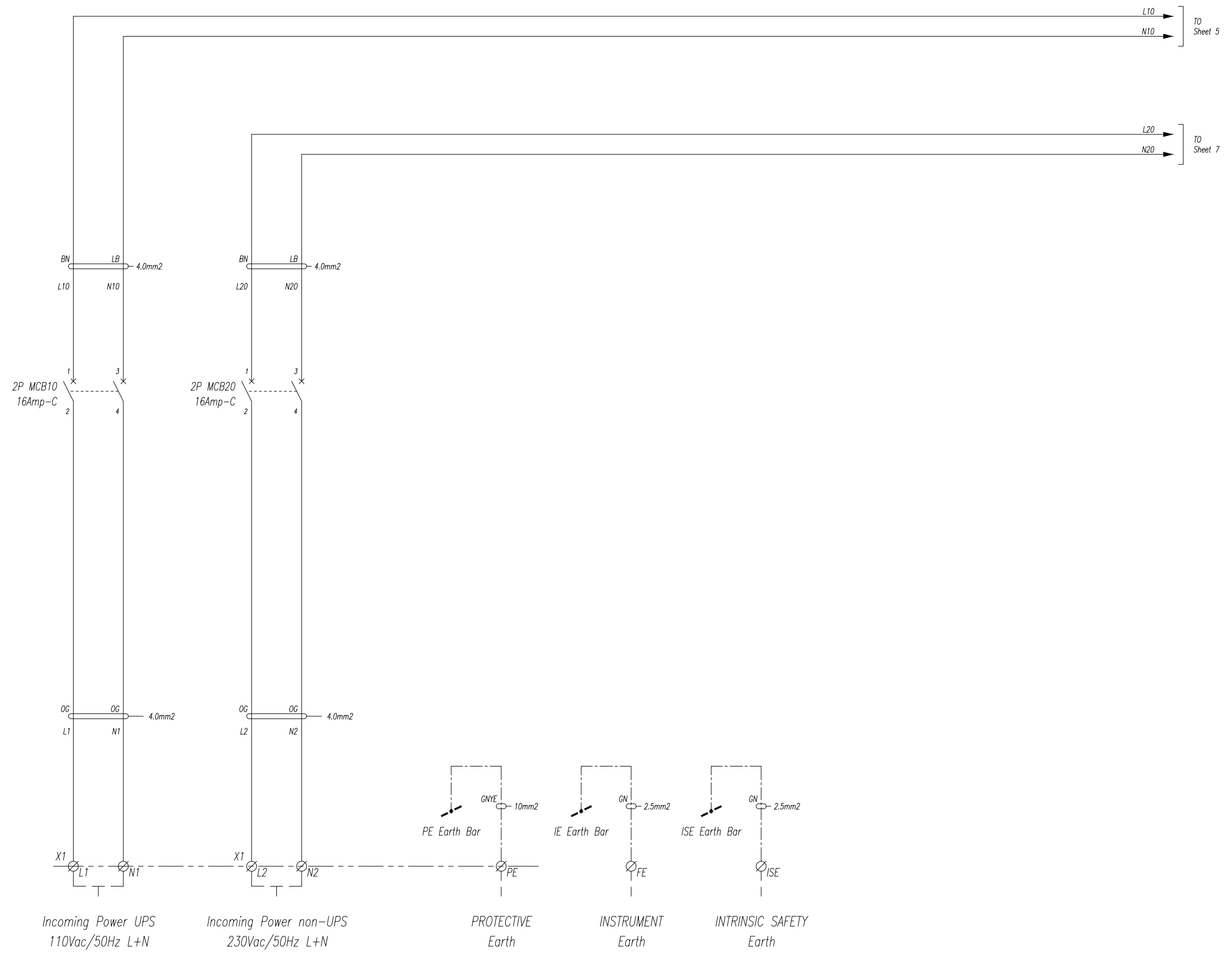

0	6/01/25	First Issue	SV	-	-	-
REV.	ISSUE DATE	DESCRIPTION	PREPARED	CHECKED	APPROVED	COMPANY
CLIENT:			CONSULTING ENGINEER:			
VENDOR:						
PROJECT: PR200						
DRAWING TITLE: PLC Wiring and Layout Drawing						
DRAWING NO. E1027-HSE-VD-IN-DIG-008			REV. R0	SIZE A3	SCALE NA	SHEET 4 / 40

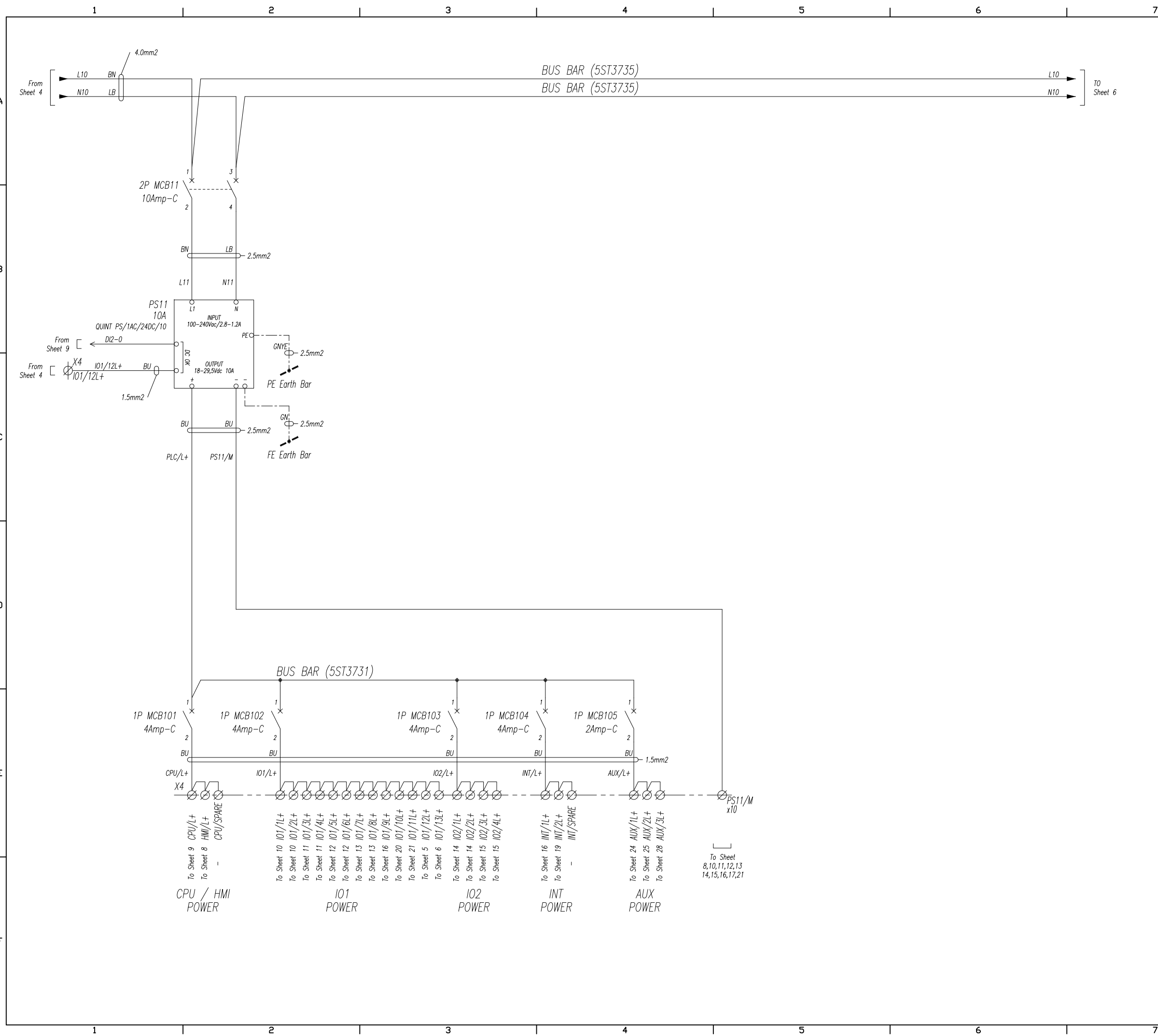

GENERAL NOTES

WIRE COLOR CODE (IEC 60757)

- BK : BLACK
- BN : BROWN
- RD : RED
- OG : ORANGE
- GN : GREEN
- BU : DARK BLUE
- LB : LIGHT BLUE
- GY : GREY
- WH : WHITE
- GNYE : GREEN AND YELLOW
- SH : SCREENING METAL

WIRE MARKER

White heat shrink type with Black letter

0	6/01/25	First issue	SV	-	-	-
REV.	ISSUE DATE	DESCRIPTION	PREPARED	CHECKED	APPROVED	COMPANY
CLIENT:			CONSULTING ENGINEER:			
VENDOR:						
PROJECT: PR200						
DRAWING TITLE: PLC Wiring and Layout Drawing						
DRAWING NO. E1027-HSE-VD-IN-DIG-008			REV. RO	SIZE A3	SCALE NA	SHEET 5 / 40

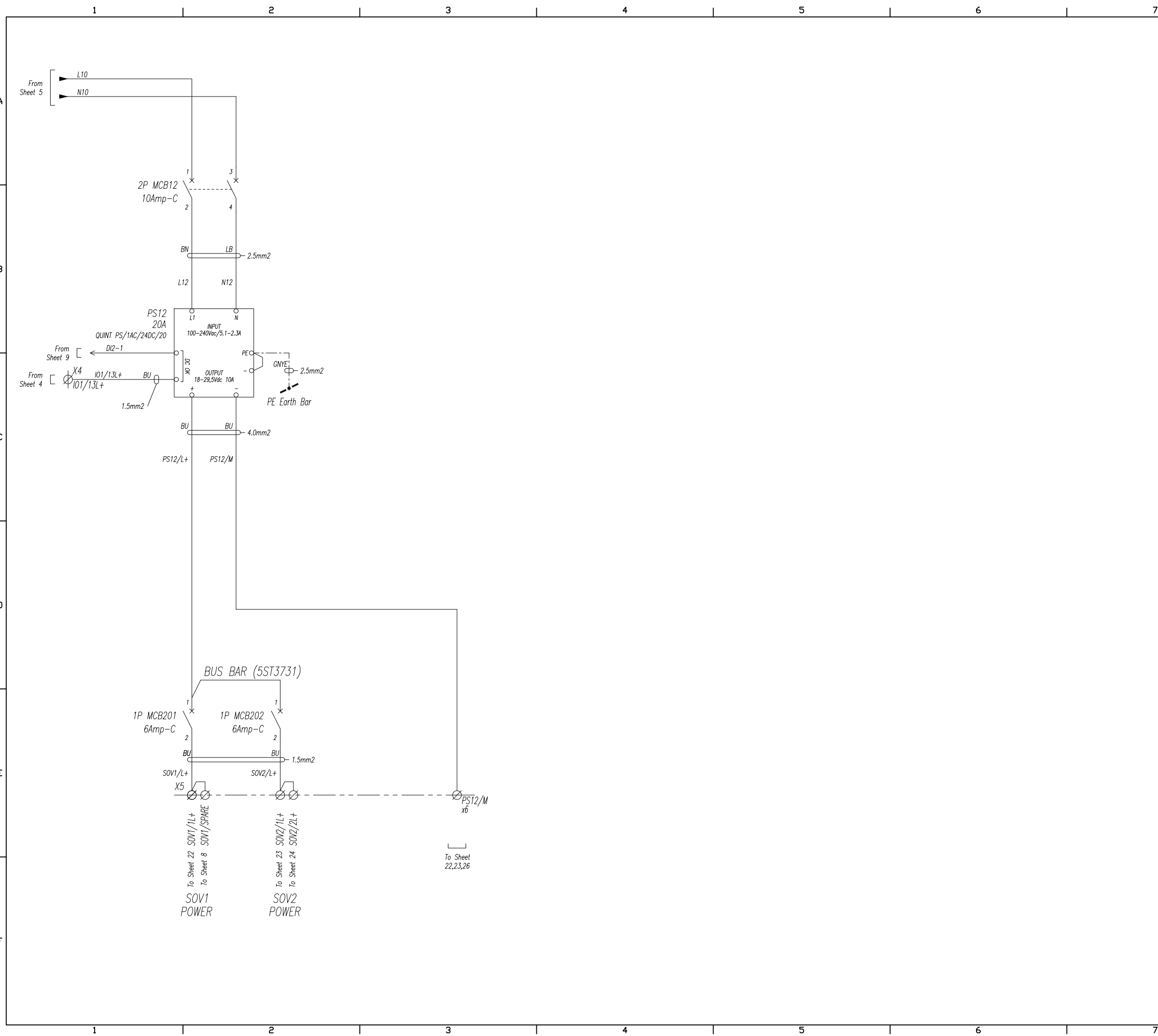

GENERAL NOTES

WIRE COLOR CODE (IEC 60757)

- BK : BLACK
- BN : BROWN
- RD : RED
- OG : ORANGE
- GN : GREEN
- BU : DARK BLUE
- LB : LIGHT BLUE
- GY : GREY
- WH : WHITE
- GNYE : GREEN AND YELLOW
- SH : SCREENING METAL

WIRE MARKER

White heat shrink type with Black letter

0	6/01/25	First Issue	SV	-	-	-
REV.	ISSUE DATE	DESCRIPTION	PREPARED	CHECKED	APPROVED	COMPANY
CLIENT:			CONSULTING ENGINEER:			
VENDOR:						
PROJECT: PR200						
DRAWING TITLE: PLC Wiring and Layout Drawing						
DRAWING NO. E1027-HSE-VD-IN-DIG-008			REV. RO	SIZE A3	SCALE NA	SHEET 6 / 40

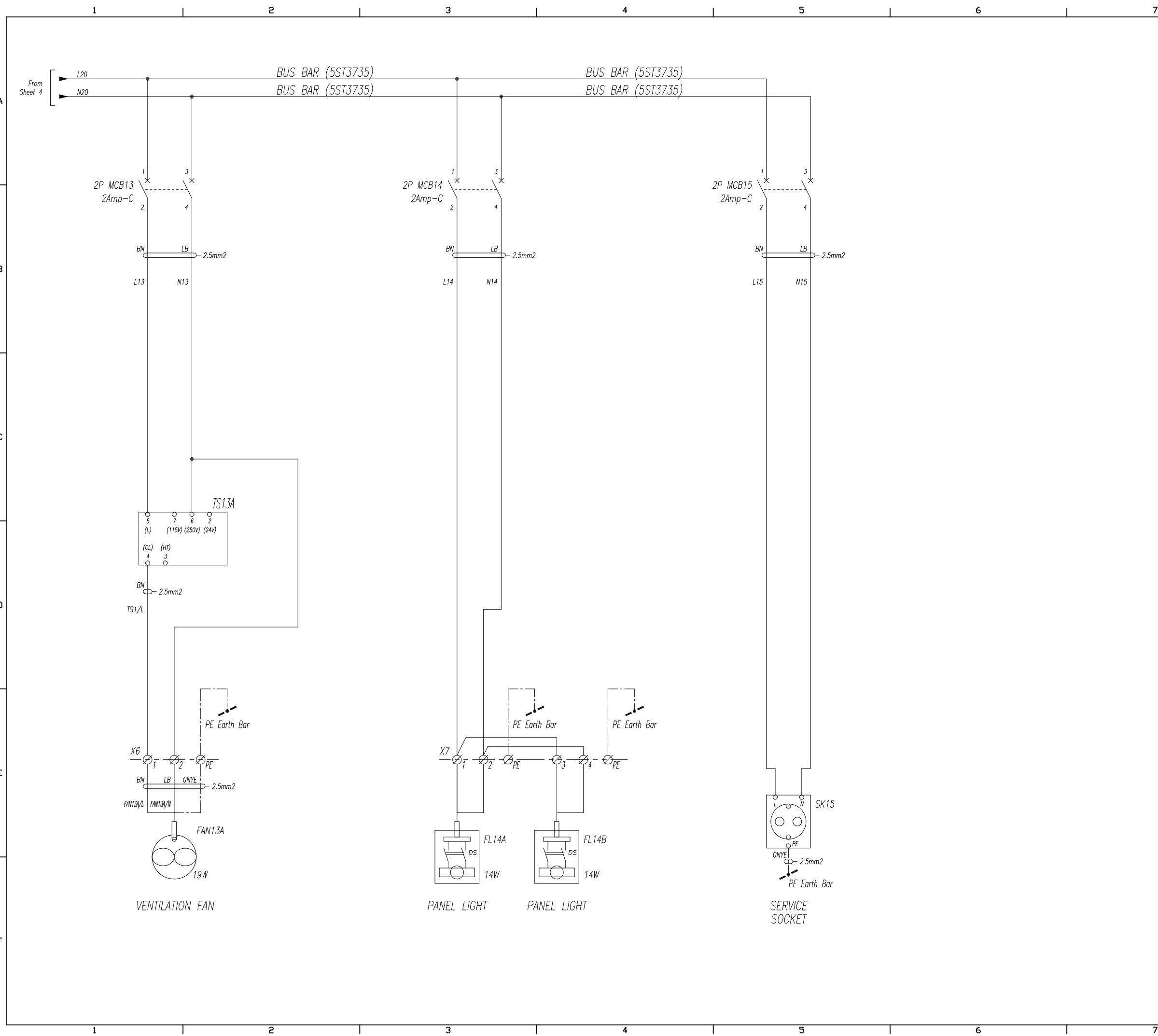

GENERAL NOTES

WIRE COLOR CODE (IEC 60757)

- BK : BLACK
- BN : BROWN
- RD : RED
- OG : ORANGE
- GN : GREEN
- BU : DARK BLUE
- LB : LIGHT BLUE
- GY : GREY
- WH : WHITE
- GNYE : GREEN AND YELLOW
- SH : SCREENING METAL

WIRE MARKER

White heat shrink type with Black letter

0	6/01/25	First Issue	SV	-	-	-
REV.	ISSUE DATE	DESCRIPTION	PREPARED	CHECKED	APPROVED	COMPANY
CLIENT:			CONSULTING ENGINEER:			
VENDOR:						
PROJECT: PR200						
DRAWING TITLE: PLC Wiring and Layout Drawing						
DRAWING NO.			REV.	SIZE	SCALE	SHEET
E1027-HSE-VD-IN-DIG-008			RO	A3	NA	7 / 40

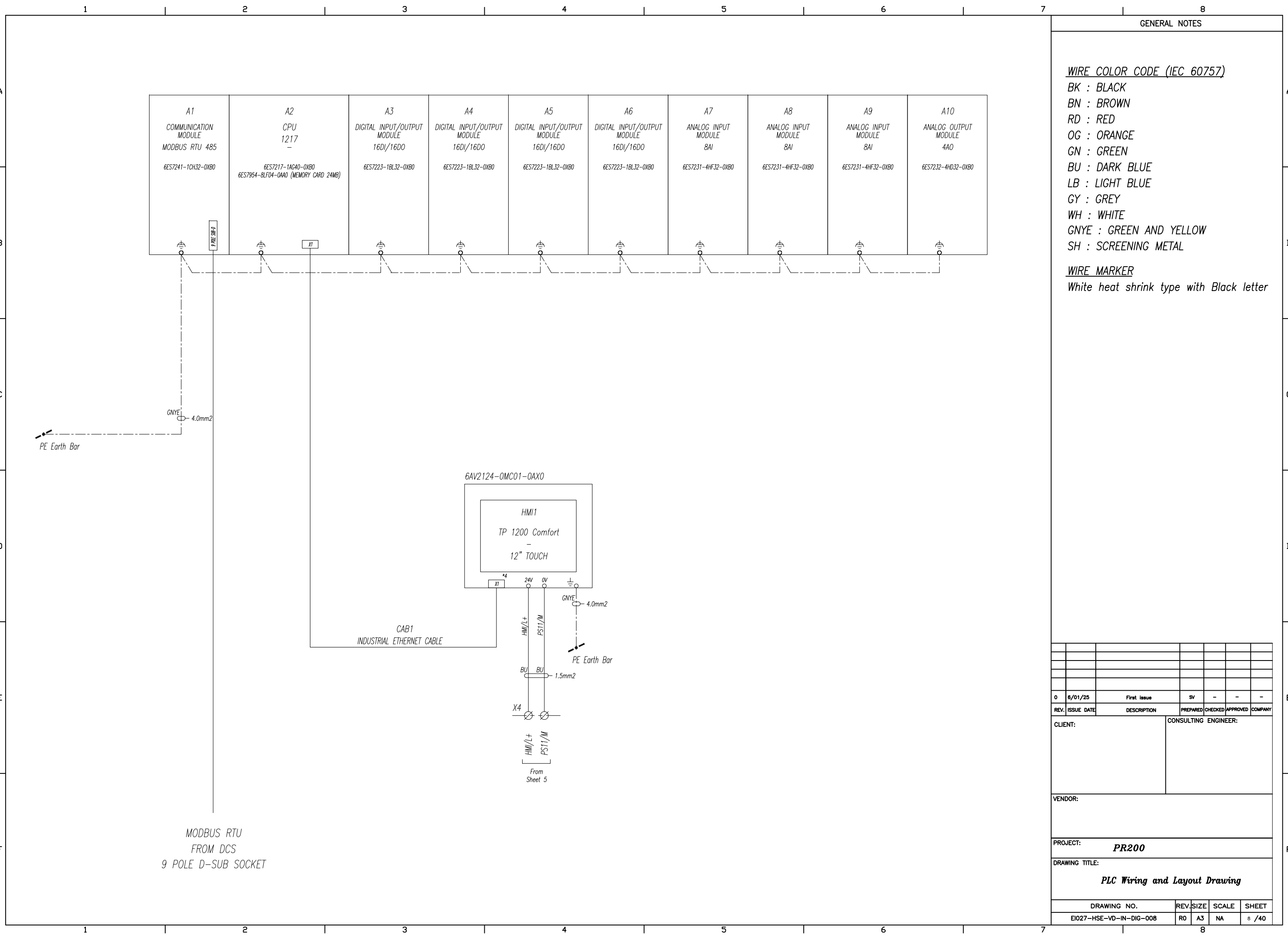

GENERAL NOTES

WIRE COLOR CODE (IEC 60757)

- BK : BLACK
- BN : BROWN
- RD : RED
- OG : ORANGE
- GN : GREEN
- BU : DARK BLUE
- LB : LIGHT BLUE
- GY : GREY
- WH : WHITE
- GNYE : GREEN AND YELLOW
- SH : SCREENING METAL

WIRE MARKER

White heat shrink type with Black letter

0	6/01/25	First Issue	SV	-	-	-
REV.	ISSUE DATE	DESCRIPTION	PREPARED	CHECKED	APPROVED	COMPANY
CLIENT:			CONSULTING ENGINEER:			
VENDOR:						
PROJECT: PR200						
DRAWING TITLE: PLC Wiring and Layout Drawing						
DRAWING NO. E1027-HSE-VD-IN-DIG-008			REV. RO	SIZE A3	SCALE NA	SHEET 8 / 40

WIRE COLOR CODE (IEC 60757)

- BK : BLACK
- BN : BROWN
- RD : RED
- OG : ORANGE
- GN : GREEN
- BU : DARK BLUE
- LB : LIGHT BLUE
- GY : GREY
- WH : WHITE
- GNYE : GREEN AND YELLOW
- SH : SCREENING METAL

WIRE MARKER

White heat shrink type with Black letter

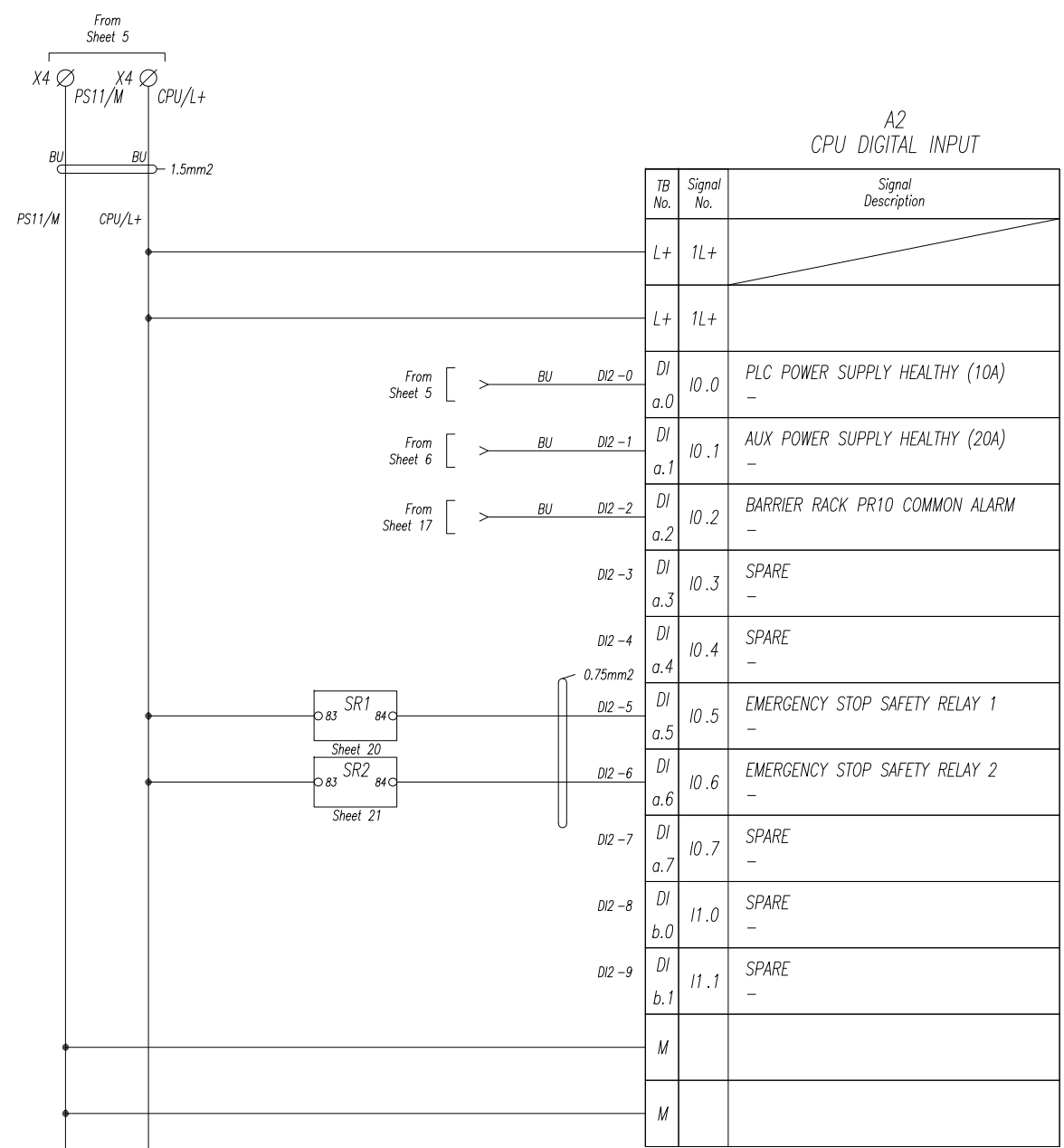

TB No.	Signal No.	Signal Description
L+	1L+	
L+	1L+	
DI a.0	10.0	PLC POWER SUPPLY HEALTHY (10A)
DI a.1	10.1	AUX POWER SUPPLY HEALTHY (20A)
DI a.2	10.2	BARRIER RACK PR10 COMMON ALARM
DI a.3	10.3	SPARE
DI a.4	10.4	SPARE
DI a.5	10.5	EMERGENCY STOP SAFETY RELAY 1
DI a.6	10.6	EMERGENCY STOP SAFETY RELAY 2
DI a.7	10.7	SPARE
DI b.0	11.0	SPARE
DI b.1	11.1	SPARE
M		
M		

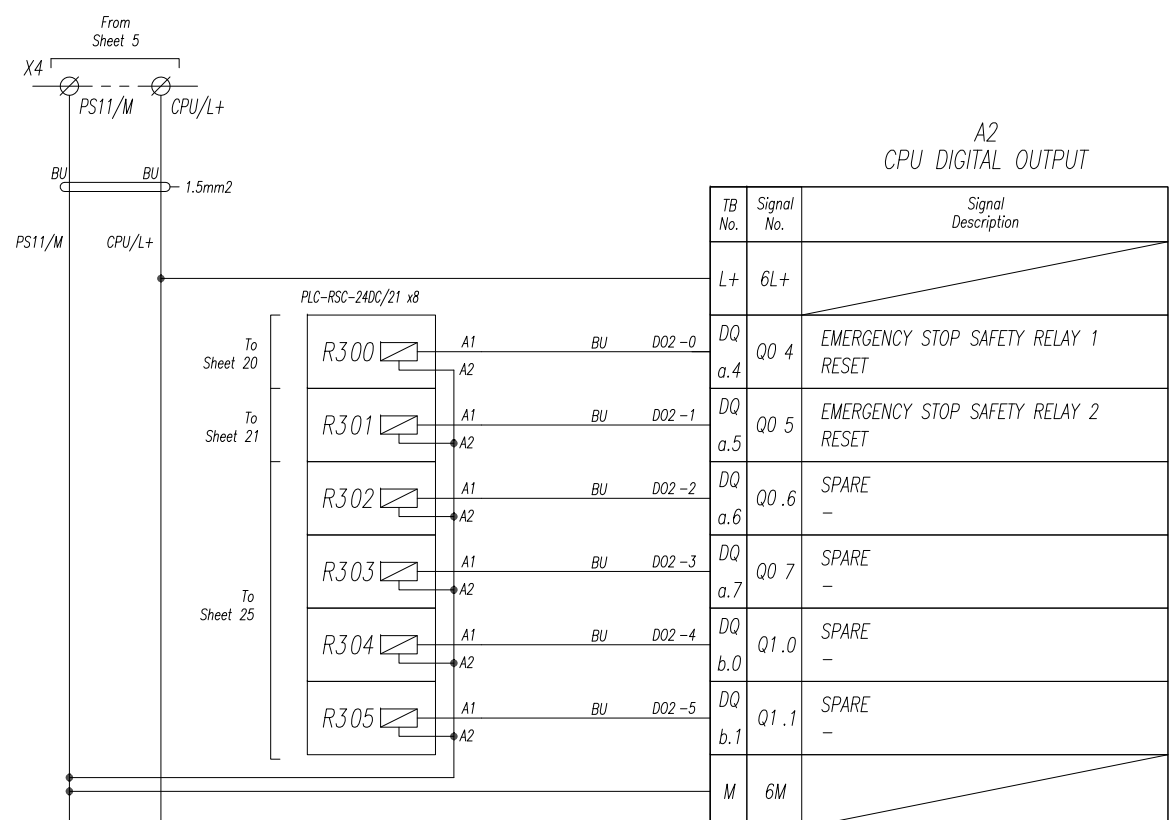

TB No.	Signal No.	Signal Description
L+	6L+	
DQ a.4	Q0.4	EMERGENCY STOP SAFETY RELAY 1 RESET
DQ a.5	Q0.5	EMERGENCY STOP SAFETY RELAY 2 RESET
DQ a.6	Q0.6	SPARE
DQ a.7	Q0.7	SPARE
DQ b.0	Q1.0	SPARE
DQ b.1	Q1.1	SPARE
M	6M	

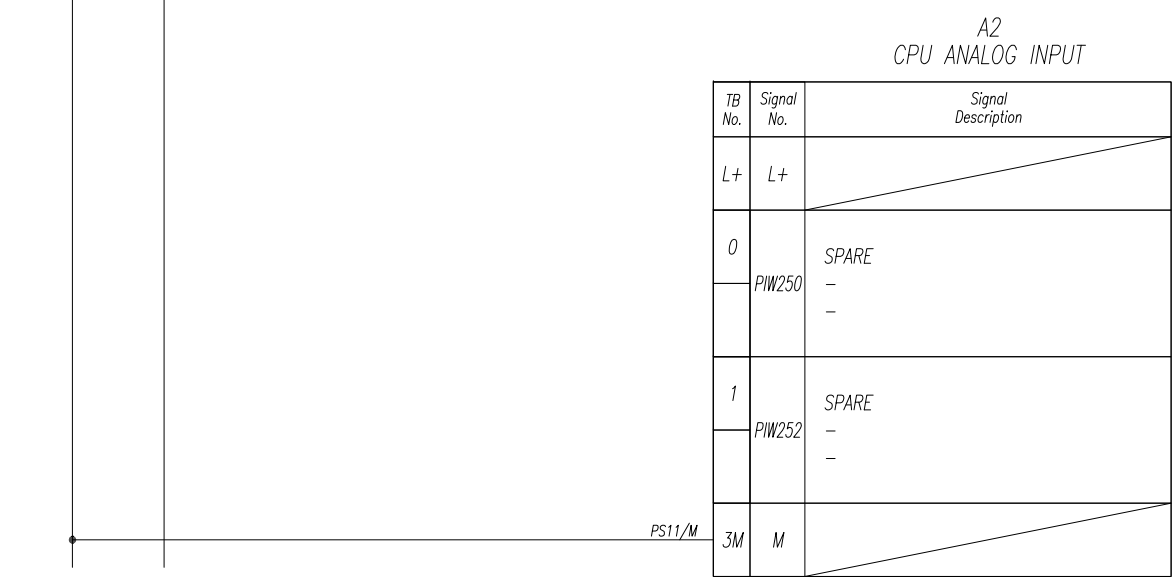

TB No.	Signal No.	Signal Description
L+	L+	
0	PIW250	SPARE
1	PIW252	SPARE
3M	M	

TB No.	Signal No.	Signal Description
L+	L+	
0	PQW250	SPARE
1	PQW252	SPARE
4M	M	

0	6/01/25	First Issue	SV	-	-
REV.	ISSUE DATE	DESCRIPTION	PREPARED	CHECKED	APPROVED
CLIENT:			CONSULTING ENGINEER:		
VENDOR:					
PROJECT: PR200					
DRAWING TITLE: PLC Wiring and Layout Drawing					
DRAWING NO. E1027-HSE-VD-IN-DIG-008			REV. R0	SIZE A3	SCALE NA
			SHEET 9	/ 40	

WIRE COLOR CODE (IEC 60757)

- BK : BLACK
- BN : BROWN
- RD : RED
- OG : ORANGE
- GN : GREEN
- BU : DARK BLUE
- LB : LIGHT BLUE
- GY : GREY
- WH : WHITE
- GNYE : GREEN AND YELLOW
- SH : SCREENING METAL

WIRE MARKER

White heat shrink type with Black letter

A3
DIGITAL INPUT/OUTPUT MODULE

TB No.	Signal No.	Signal Description
DI a.0	I36.0	UNIT A START PB HST-RU0001A-01
DI a.1	I36.1	UNIT A STOP PB HSP-RU0001A-01
DI a.2	I36.2	OIL PUMP START PB HST-RU0001A-06
DI a.3	I36.3	OIL PUMP STOP PB HSP-RU0001A-06
DI a.4	I36.4	COMP CAPACITY CONTROL REMOTE/LOCAL SELECT SWITCH (1=LOCAL, 0 = REMOTE) HS-RU0001A-01
DI a.5	I36.5	LAMP TEST PB HS-RU0001A-03
DI a.6	I36.6	UNIT A LOCAL/REMOTE SELECT SWITCH (1=LOCAL, 0=REMOTE) HSC-RU0001A-01
DI a.7	I36.7	OIL PUMP HAND/AUTO SELECT SWITCH AUTO SELECT HSC-RU0001A-06A
DI b.0	I37.0	OIL PUMP HAND/AUTO SELECT SWITCH HAND SELECT HSC-RU0001A-06B
DI b.1	I37.1	COMP CAPACITY CONTROL LOAD/UNLOAD SELECT SWITCH LOAD SELECT HS-RU0001A-02A
DI b.2	I37.2	COMP CAPACITY CONTROL LOAD/UNLOAD SELECT SWITCH UNLOAD SELECT HS-RU0001A-02B
DI b.3	I37.3	SPARE
DI b.4	I37.4	SPARE
DI b.5	I37.5	SPARE
DI b.6	I37.6	AIR COOLER A MOTOR 2 VIBRATION SWITCH VS-RU0001A-01A
DI b.7	I37.7	AIR COOLER A MOTOR 3 VIBRATION SWITCH VS-RU0001A-01B
1M		
2M		
M		

A4
DIGITAL INPUT/OUTPUT MODULE

TB No.	Signal No.	Signal Description
DI a.0	I38.0	UNIT B START PB HST-RU0001B-01
DI a.1	I38.1	UNIT B STOP PB HSP-RU0001B-01
DI a.2	I38.2	OIL PUMP B START PB HST-RU0001B-06
DI a.3	I38.3	OIL PUMP B STOP PB HSP-RU0001B-06
DI a.4	I38.4	COMP B CAPACITY CONTROL REMOTE/LOCAL SELECT SWITCH (1=LOCAL, 0 = REMOTE) HS-RU0001B-01
DI a.5	I38.5	LAMP TEST B PB HS-RU0001B-03
DI a.6	I38.6	UNIT B LOCAL/REMOTE SELECT SWITCH (1=LOCAL, 0=REMOTE) HSC-RU0001B-01
DI a.7	I38.7	OIL PUMP B HAND/AUTO SELECT SWITCH AUTO SELECT HSC-RU0001B-06A
DI b.0	I39.0	OIL PUMP B HAND/AUTO SELECT SWITCH HAND SELECT HSC-RU0001B-06B
DI b.1	I39.1	COMP B CAPACITY CONTROL LOAD/UNLOAD SELECT SWITCH LOAD SELECT HS-RU0001B-02A
DI b.2	I39.2	COMP B CAPACITY CONTROL LOAD/UNLOAD SELECT SWITCH UNLOAD SELECT HS-RU0001B-02B
DI b.3	I39.3	SPARE
DI b.4	I39.4	SPARE
DI b.5	I39.5	SPARE
DI b.6	I39.6	AIR COOLER A MOTOR 2 VIBRATION SWITCH VS-RU0001A-01A
DI b.7	I39.7	AIR COOLER A MOTOR 3 VIBRATION SWITCH VS-RU0001A-01B
1M		
2M		
40		

0	6/01/25	First Issue	SV	-	-	-
REV.	ISSUE DATE	DESCRIPTION	PREPARED	CHECKED	APPROVED	COMPANY

CLIENT: _____ CONSULTING ENGINEER: _____

VENDOR: _____

PROJECT: **PR200**

DRAWING TITLE: **PLC Wiring and Layout Drawing**

DRAWING NO.	REV.	SIZE	SCALE	SHEET
E1027-HSE-VD-IN-DIG-008	RO	A3	NA	10/40

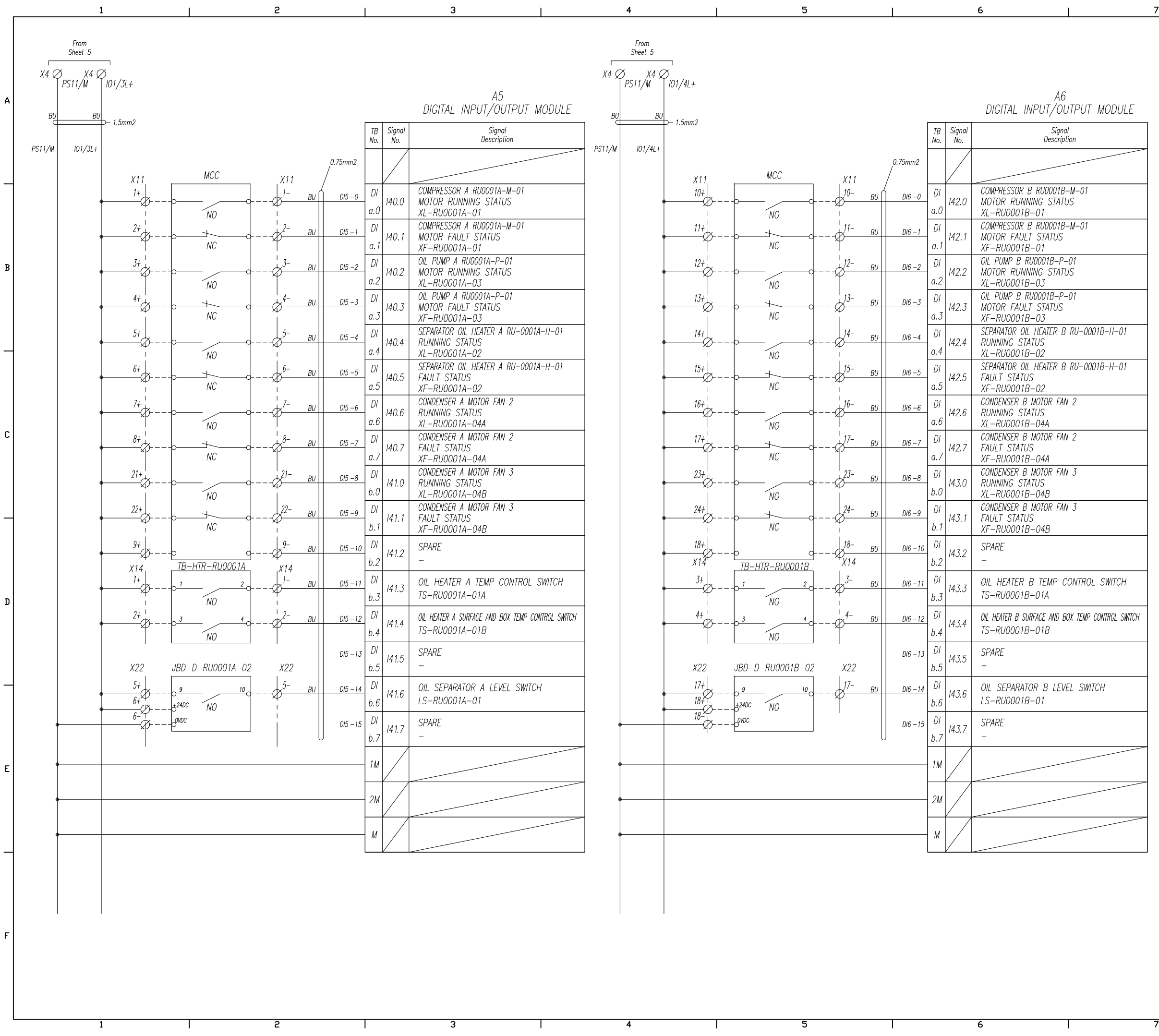

GENERAL NOTES

WIRE COLOR CODE (IEC 60757)

- BK : BLACK
- BN : BROWN
- RD : RED
- OG : ORANGE
- GN : GREEN
- BU : DARK BLUE
- LB : LIGHT BLUE
- GY : GREY
- WH : WHITE
- GNYE : GREEN AND YELLOW
- SH : SCREENING METAL

WIRE MARKER

White heat shrink type with Black letter

0	6/01/25	First Issue	SV	-	-
REV.	ISSUE DATE	DESCRIPTION	PREPARED	CHECKED	APPROVED
CLIENT:			CONSULTING ENGINEER:		
VENDOR:					
PROJECT: PR200					
DRAWING TITLE: PLC Wiring and Layout Drawing					
DRAWING NO.		REV.	SIZE	SCALE	SHEET
E1027-HSE-VD-IN-DIG-008		RO	A3	NA	11/40

WIRE COLOR CODE (IEC 60757)

- BK : BLACK
- BN : BROWN
- RD : RED
- OG : ORANGE
- GN : GREEN
- BU : DARK BLUE
- LB : LIGHT BLUE
- GY : GREY
- WH : WHITE
- GNYE : GREEN AND YELLOW
- SH : SCREENING METAL

WIRE MARKER

White heat shrink type with Black letter

A3
DIGITAL INPUT/OUTPUT MODULE

TB No.	Signal No.	Signal Description
L+	1L+	
DQ	Q36.0	COMPRESSOR A RU0001A-M-01 MOTOR START COMMAND XST-RU0001A-01
a.0		
DQ	Q36.1	COMPRESSOR A RU0001A-M-01 MOTOR STOP COMMAND XSP-RU0001A-01
a.1		
DQ	Q36.2	OIL PUMP A RU0001A-P-01 MOTOR START COMMAND XST-RU0001A-02
a.2		
DQ	Q36.3	OIL PUMP A RU0001A-P-01 MOTOR STOP COMMAND XSP-RU0001A-02
a.3		
DQ	Q36.4	SEPARATOR OIL HEATER A RU0001A-H-01 ON COMMAND XS-RU0001A-01B
a.4		
DQ	Q36.5	SEPARATOR OIL HEATER A RU0001A-H-01 OFF COMMAND XS-RU0001A-01C
a.5		
DQ	Q36.6	SPARE -
a.6		
DQ	Q36.7	SPARE -
a.7		
DQ	Q37.0	CONDENSER A MOTOR FAN 2 START COMMAND XST-RU0001A-03A
b.0		
DQ	Q37.1	CONDENSER A MOTOR FAN 2 STOP COMMAND XSP-RU0001A-03A
b.1		
DQ	Q37.2	CONDENSER A MOTOR FAN 3 START COMMAND XST-RU0001A-03B
b.2		
DQ	Q37.3	CONDENSER A MOTOR FAN 3 STOP COMMAND XSP-RU0001A-03B
b.3		
DQ	Q37.4	
b.4		
DQ	Q37.5	
b.5		
DQ	Q37.6	
b.6		
DQ	Q37.7	
b.7		

A4
DIGITAL INPUT/OUTPUT MODULE

TB No.	Signal No.	Signal Description
L+	1L+	
DQ	Q38.0	COMPRESSOR B RU0001B-M-01 MOTOR START COMMAND XST-RU0001B-01
a.0		
DQ	Q38.1	COMPRESSOR B RU0001B-M-01 MOTOR STOP COMMAND XSP-RU0001B-01
a.1		
DQ	Q38.2	OIL PUMP B RU0001B-P-01 MOTOR START COMMAND XST-RU0001B-02
a.2		
DQ	Q38.3	OIL PUMP B RU0001B-P-01 MOTOR STOP COMMAND XSP-RU0001B-02
a.3		
DQ	Q38.4	SEPARATOR OIL HEATER B RU0001B-H-01 ON COMMAND XS-RU0001B-01B
a.4		
DQ	Q38.5	SEPARATOR OIL HEATER B RU0001B-H-01 OFF COMMAND XS-RU0001B-01C
a.5		
DQ	Q38.6	SPARE -
a.6		
DQ	Q38.7	SPARE -
a.7		
DQ	Q39.0	CONDENSER B MOTOR FAN 2 START COMMAND XST-RU0001B-03A
b.0		
DQ	Q39.1	CONDENSER B MOTOR FAN 2 STOP COMMAND XSP-RU0001B-03A
b.1		
DQ	Q39.2	CONDENSER B MOTOR FAN 3 START COMMAND XST-RU0001B-03B
b.2		
DQ	Q39.3	CONDENSER B MOTOR FAN 3 STOP COMMAND XSP-RU0001B-03B
b.3		
DQ	Q39.4	
b.4		
DQ	Q39.5	
b.5		
DQ	Q39.6	
b.6		
DQ	Q39.7	
b.7		

0	6/01/25	First Issue	SV	-	-	-
REV.	ISSUE DATE	DESCRIPTION	PREPARED	CHECKED	APPROVED	COMPANY

CLIENT: _____ CONSULTING ENGINEER: _____

VENDOR: _____

PROJECT: **PR200**

DRAWING TITLE: **PLC Wiring and Layout Drawing**

DRAWING NO.	REV.	SIZE	SCALE	SHEET
E1027-HSE-VD-IN-DIG-008	RO	A3	NA	12/40

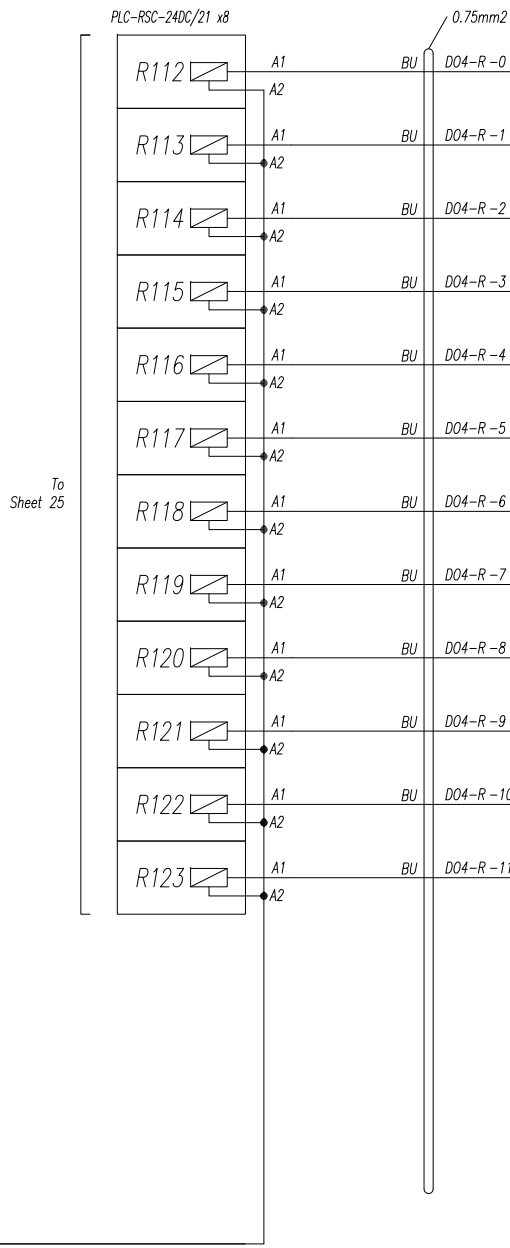
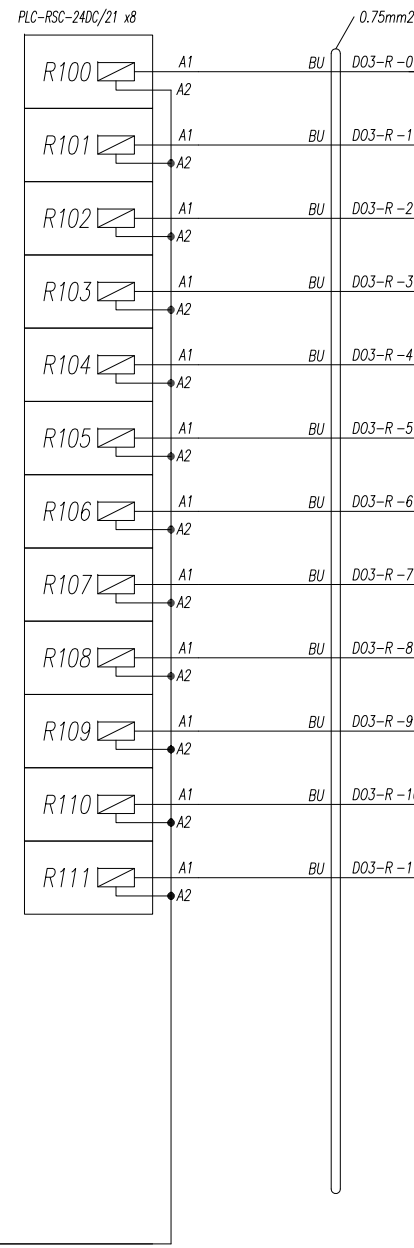
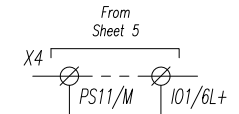
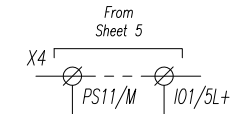

To Sheet 25

To Sheet 25

WIRE COLOR CODE (IEC 60757)

- BK : BLACK
- BN : BROWN
- RD : RED
- OG : ORANGE
- GN : GREEN
- BU : DARK BLUE
- LB : LIGHT BLUE
- GY : GREY
- WH : WHITE
- GNYE : GREEN AND YELLOW
- SH : SCREENING METAL

WIRE MARKER

White heat shrink type with Black letter

0	6/01/25	First Issue	SV	-	-	-
REV.	ISSUE DATE	DESCRIPTION	PREPARED	CHECKED	APPROVED	COMPANY

CLIENT: _____ CONSULTING ENGINEER: _____

VENDOR: _____

PROJECT: **PR200**

DRAWING TITLE: **PLC Wiring and Layout Drawing**

DRAWING NO.	REV.	SIZE	SCALE	SHEET
E1027-HSE-VD-IN-DIG-008	RO	A3	NA	13/40

A5
DIGITAL INPUT/OUTPUT MODULE

TB No.	Signal No.	Signal Description
L+	1L+	
DQ	Q40.0	COMPRESSOR A CAPACITY CONTROL UNLOAD RETURN SOV SOV-RU0001A-01E
a.0		
DQ	Q40.1	COMPRESSOR A CAPACITY CONTROL LOAD SUPPLY SOV SOV-RU0001A-01C
a.1		
DQ	Q40.2	COMPRESSOR A CAPACITY CONTROL UNLOAD SUPPLY SOV SOV-RU0001A-01A
a.2		
DQ	Q40.3	COMPRESSOR A CAPACITY CONTROL LOAD RETURN SOV SOV-RU0001A-01D
a.3		
DQ	Q40.4	HOT GAS A SOV SOV-RU0001A-03
a.4		
DQ	Q40.5	EVAPORATOR A OIL DRAIN LINE SOV SOV-RU0001A-02
a.5		
DQ	Q40.6	SPARE -
a.6		
DQ	Q40.7	SPARE -
a.7		
DQ	Q41.0	UNIT A COMMON ALARM LAMP XL-RU0001A-01
b.0		
DQ	Q41.1	UNIT A COMMON TRIP LAMP XA-RU0001A-02
b.1		
DQ	Q41.2	UNIT A READY TO START LAMP XL-RU0001A-05
b.2		
DQ	Q41.3	COMPRESSOR A RUNNING LAMP XL-RU0001A-06
b.3		
DQ	Q41.4	OIL PUMP A RUNNING LAMP HLR-RU0001A-06
b.4		
DQ	Q41.5	SPARE -
b.5		
DQ	Q41.6	SPARE -
b.6		
DQ	Q41.7	SPARE -
b.7		

A6
DIGITAL INPUT/OUTPUT MODULE

TB No.	Signal No.	Signal Description
L+	1L+	
DQ	Q42.0	COMPRESSOR B CAPACITY CONTROL UNLOAD RETURN SOV SOV-RU0001B-01E
a.0		
DQ	Q42.1	COMPRESSOR B CAPACITY CONTROL LOAD SUPPLY SOV SOV-RU0001B-01C
a.1		
DQ	Q42.2	COMPRESSOR B CAPACITY CONTROL UNLOAD SUPPLY SOV SOV-RU0001B-01A
a.2		
DQ	Q42.3	COMPRESSOR B CAPACITY CONTROL LOAD RETURN SOV SOV-RU0001B-01D
a.3		
DQ	Q42.4	HOT GAS B SOV SOV-RU0001B-03
a.4		
DQ	Q42.5	EVAPORATOR B OIL DRAIN LINE SOV SOV-RU0001B-02
a.5		
DQ	Q42.6	SPARE -
a.6		
DQ	Q42.7	SPARE -
a.7		
DQ	Q43.0	UNIT B COMMON ALARM LAMP XL-RU0001B-01
b.0		
DQ	Q43.1	UNIT B COMMON TRIP LAMP XA-RU0001B-02
b.1		
DQ	Q43.2	UNIT B READY TO START LAMP XL-RU0001B-05
b.2		
DQ	Q43.3	COMPRESSOR B RUNNING LAMP XL-RU0001B-06
b.3		
DQ	Q43.4	OIL PUMP B RUNNING LAMP HLR-RU0001B-06
b.4		
DQ	Q43.5	SPARE -
b.5		
DQ	Q43.6	SPARE -
b.6		
DQ	Q43.7	SPARE -
b.7		

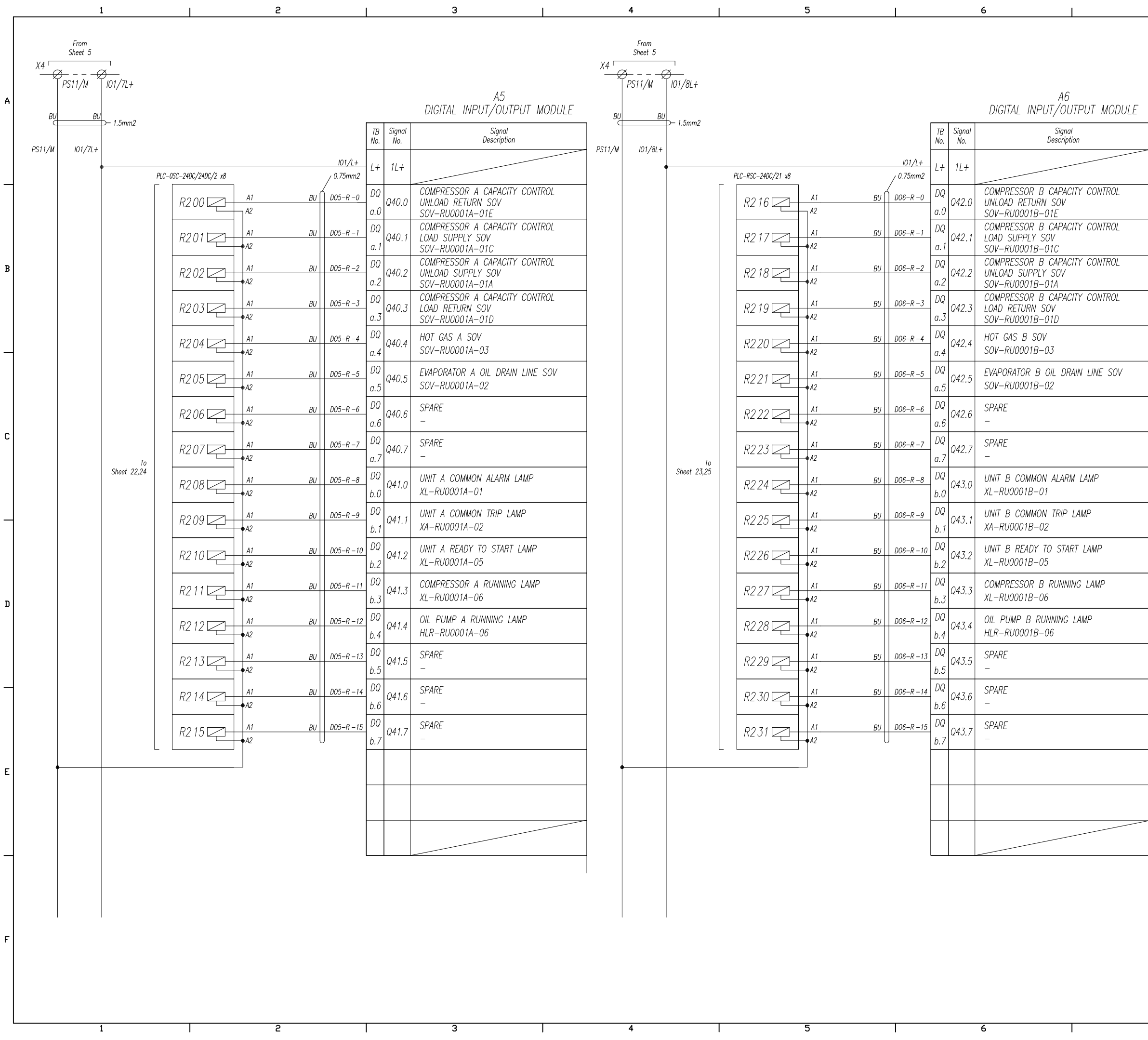

WIRE COLOR CODE (IEC 60757)

- BK : BLACK
- BN : BROWN
- RD : RED
- OG : ORANGE
- GN : GREEN
- BU : DARK BLUE
- LB : LIGHT BLUE
- GY : GREY
- WH : WHITE
- GNYE : GREEN AND YELLOW
- SH : SCREENING METAL

WIRE MARKER

White heat shrink type with Black letter

A7
ANALOG INPUT MODULE

TB No.	Signal No.	Signal Description
L+	L+	
0+	PIW160	COMPRESSOR A SUCTION PRESSURE TRANSMITTER PIT-RU0001A-01
0-		
1+	PIW162	OIL HEADER COMPRESSOR A PRESSURE TRANSMITTER PIT-RU0001A-02
1-		
2+	PIW164	DISCHARGE A PRESSURE TRANSMITTER PIT-RU0001A-03
2-		
3+	PIW166	OIL SEPARATOR A PRESSURE TRANSMITTER PIT-RU0001A-04
3-		
4+	PIW168	UPSTREAM OIL FILTER A PRESSURE TRANSMITTER PIT-RU0001A-05
4-		
5+	PIW170	DOWNSTREAM OIL FILTER A PRESSURE TRANSMITTER PIT-RU0001A-06
5-		
6+	PIW172	COMPRESSOR SUCTION A TEMPERATURE TRANSMITTER TIT-RU0001A-01
6-		
7+	PIW174	OIL HEADER COMPRESSOR A TEMPERATURE TRANSMITTER TIT-RU0001A-02
7-		
M	M	

A8
ANALOG INPUT MODULE

TB No.	Signal No.	Signal Description
L+	L+	
0+	PIW176	OIL SEPARATOR A TEMPERATURE TRANSMITTER TIT-RU0001A-03
0-		
1+	PIW178	COMPRESSOR SLIDE VALVE A POSITION TRANSMITTER ZIT-RU0001A-01
1-		
2+	PIW180	COMPRESSOR B SUCTION PRESSURE TRANSMITTER PIT-RU0001B-01
2-		
3+	PIW182	OIL HEADER COMPRESSOR B PRESSURE TRANSMITTER PIT-RU0001B-02
3-		
4+	PIW184	DISCHARGE B PRESSURE TRANSMITTER PIT-RU0001B-03
4-		
5+	PIW186	OIL SEPARATOR B PRESSURE TRANSMITTER PIT-RU0001B-04
5-		
6+	PIW188	UPSTREAM OIL FILTER B PRESSURE TRANSMITTER PIT-RU0001B-05
6-		
7+	PIW190	DOWNSTREAM OIL FILTER B PRESSURE TRANSMITTER PIT-RU0001B-06
7-		
M	M	

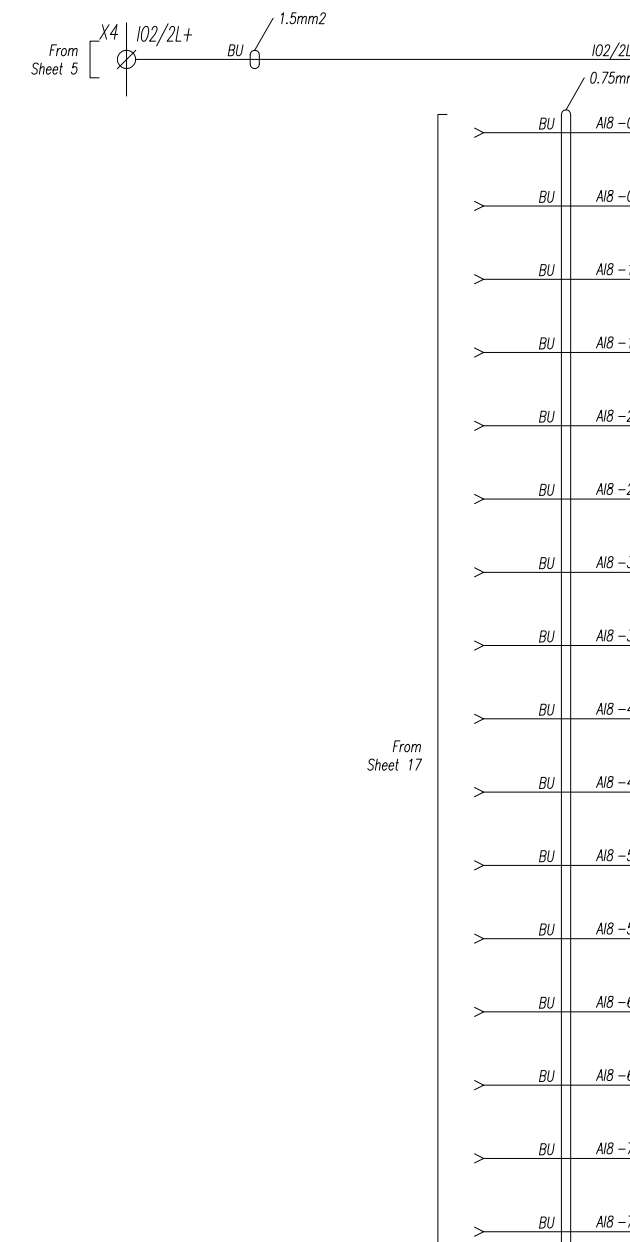
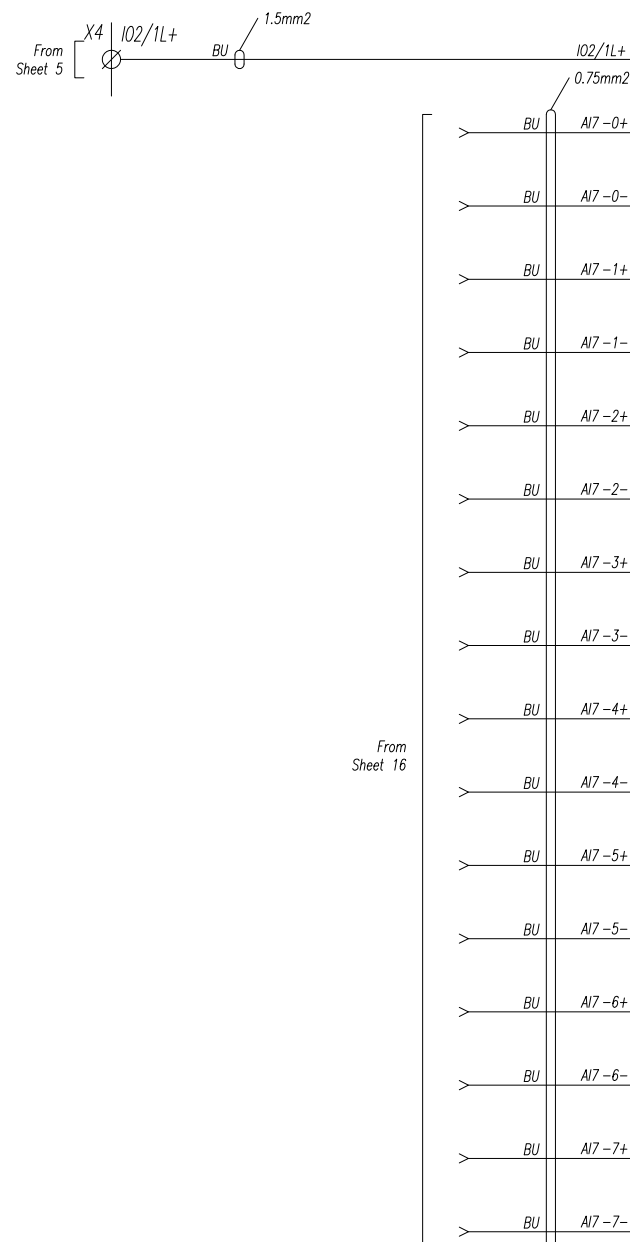

0	6/01/25	First Issue	SV	-	-
REV.	ISSUE DATE	DESCRIPTION	PREPARED	CHECKED	APPROVED
CLIENT:			CONSULTING ENGINEER:		
VENDOR:					
PROJECT: PR200					
DRAWING TITLE: PLC Wiring and Layout Drawing					
DRAWING NO. E1027-HSE-VD-IN-DIG-008			REV. RO	SIZE A3	SCALE NA
					SHEET 14/40

WIRE COLOR CODE (IEC 60757)

- BK : BLACK
- BN : BROWN
- RD : RED
- OG : ORANGE
- GN : GREEN
- BU : DARK BLUE
- LB : LIGHT BLUE
- GY : GREY
- WH : WHITE
- GNYE : GREEN AND YELLOW
- SH : SCREENING METAL

WIRE MARKER

White heat shrink type with Black letter

A9
ANALOG INPUT MODULE

TB No.	Signal No.	Signal Description
L+	L+	
0+	PIW192	COMPRESSOR SUCTION B TEMPERATURE TRANSMITTER TIT-RU0001B-01
0-		
1+	PIW194	OIL HEADER COMPRESSOR B TEMPERATURE TRANSMITTER TIT-RU0001B-02
1-		
2+	PIW196	OIL SEPARATOR B TEMPERATURE TRANSMITTER TIT-RU0001B-03
2-		
3+	PIW198	COMPRESSOR SLIDE VALVE B POSITION TRANSMITTER ZIT-RU0001B-01
3-		
4+	PIW200	CHILLER A LIQUID LEVEL TRANSMITTER LIT-RU0001A-01
4-		
5+	PIW202	CHILLER B LIQUID LEVEL TRANSMITTER LIT-RU0001B-01
5-		
6+	PIW204	COMPRESSOR A MOTOR AMPERAGE II-RU0001A-01
6-		
7+	PIW206	COMPRESSOR B MOTOR AMPERAGE II-RU0001B-01
7-		
M	M	

A10
ANALOG OUTPUT MODULE

TB No.	Signal No.	Signal Description
L+	L+	
0	PQW208	CHILLER A LEVEL CONTROL VALVE POSITION ORDER LV-RU0001A-01
0M		
1	PQW210	CHILLER B LEVEL CONTROL VALVE POSITION ORDER LV-RU0001B-01
1M		
2	PQW212	CONDENSER A VFD CONTROL - PIC-RU0001A-04
2M		
3	PQW214	CONDENSER B VFD CONTROL - PIC-RU0001B-04
3M		
M	M	

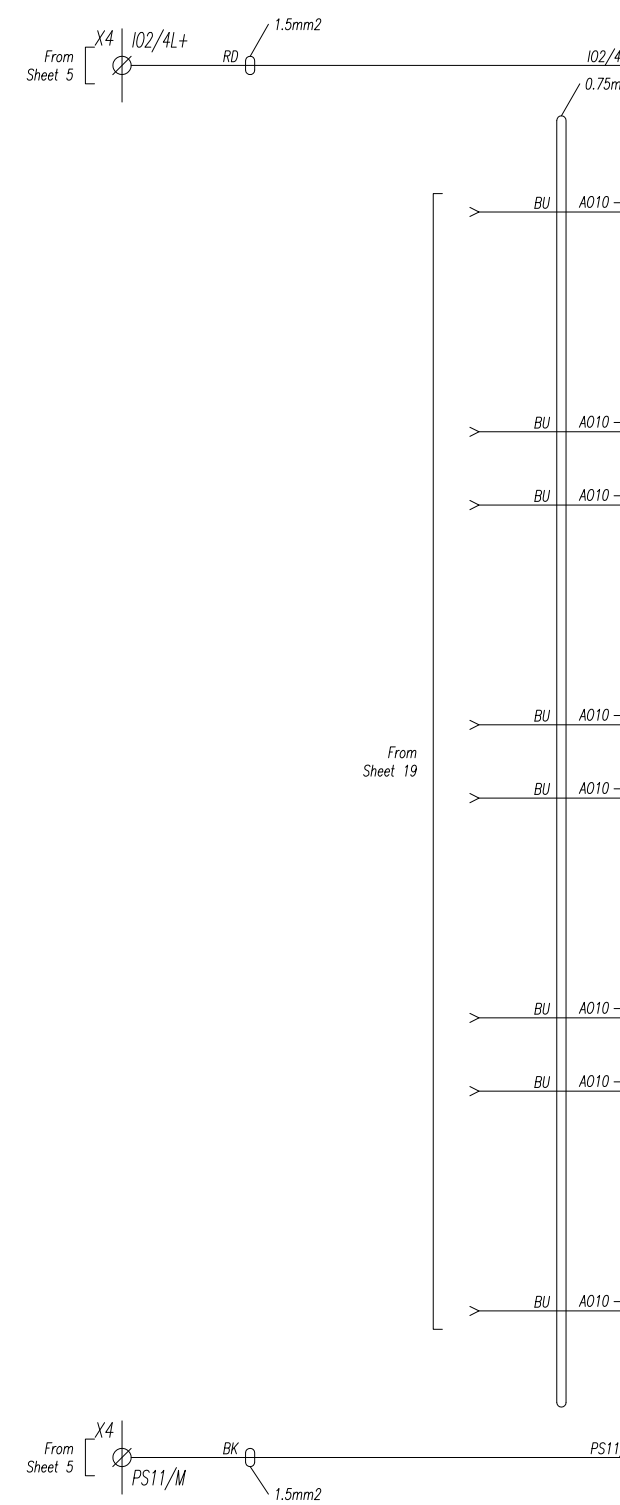
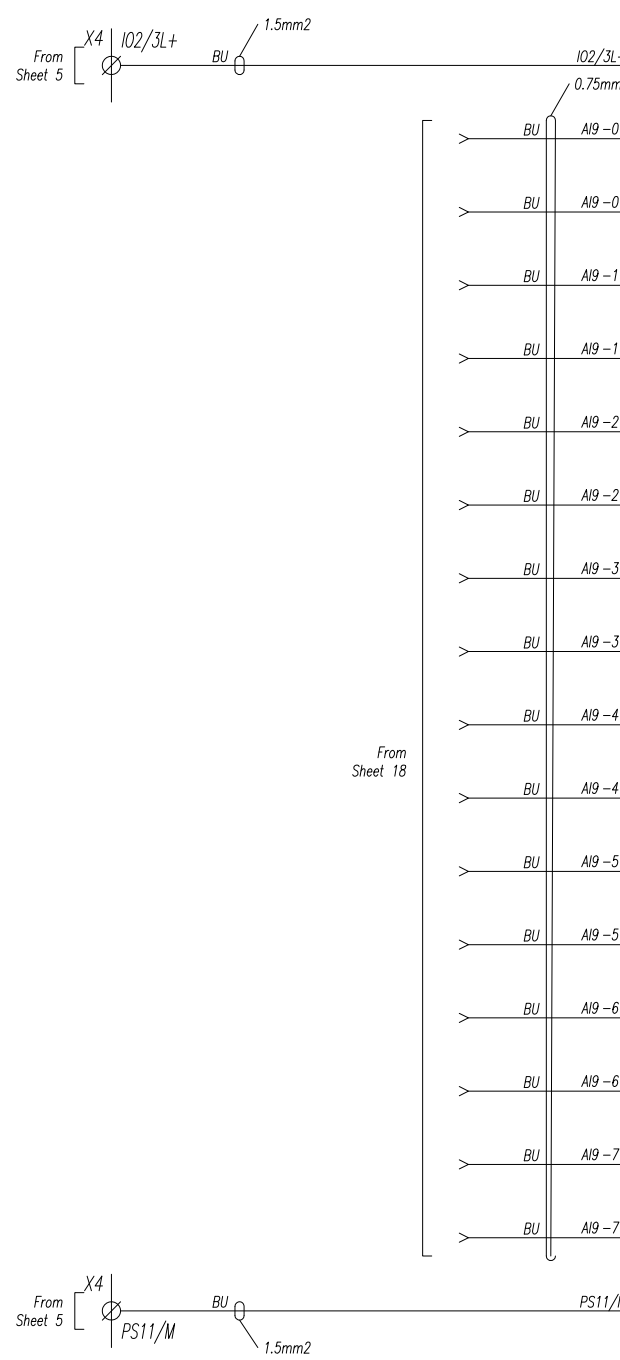

0	6/01/25	First Issue	SV	-	-	-
REV.	ISSUE DATE	DESCRIPTION	PREPARED	CHECKED	APPROVED	COMPANY

CLIENT: _____ CONSULTING ENGINEER: _____

VENDOR: _____

PROJECT: **PR200**

DRAWING TITLE: **PLC Wiring and Layout Drawing**

DRAWING NO.	REV.	SIZE	SCALE	SHEET
E1027-HSE-VD-IN-DIG-008	R0	A3	NA	15/40

GENERAL NOTES

WIRE COLOR CODE (IEC 60757)

- BK : BLACK
- BN : BROWN
- RD : RED
- OG : ORANGE
- GN : GREEN
- BU : DARK BLUE
- LB : LIGHT BLUE
- GY : GREY
- WH : WHITE
- GNYE : GREEN AND YELLOW
- SH : SCREENING METAL

WIRE MARKER

White heat shrink type with Black letter

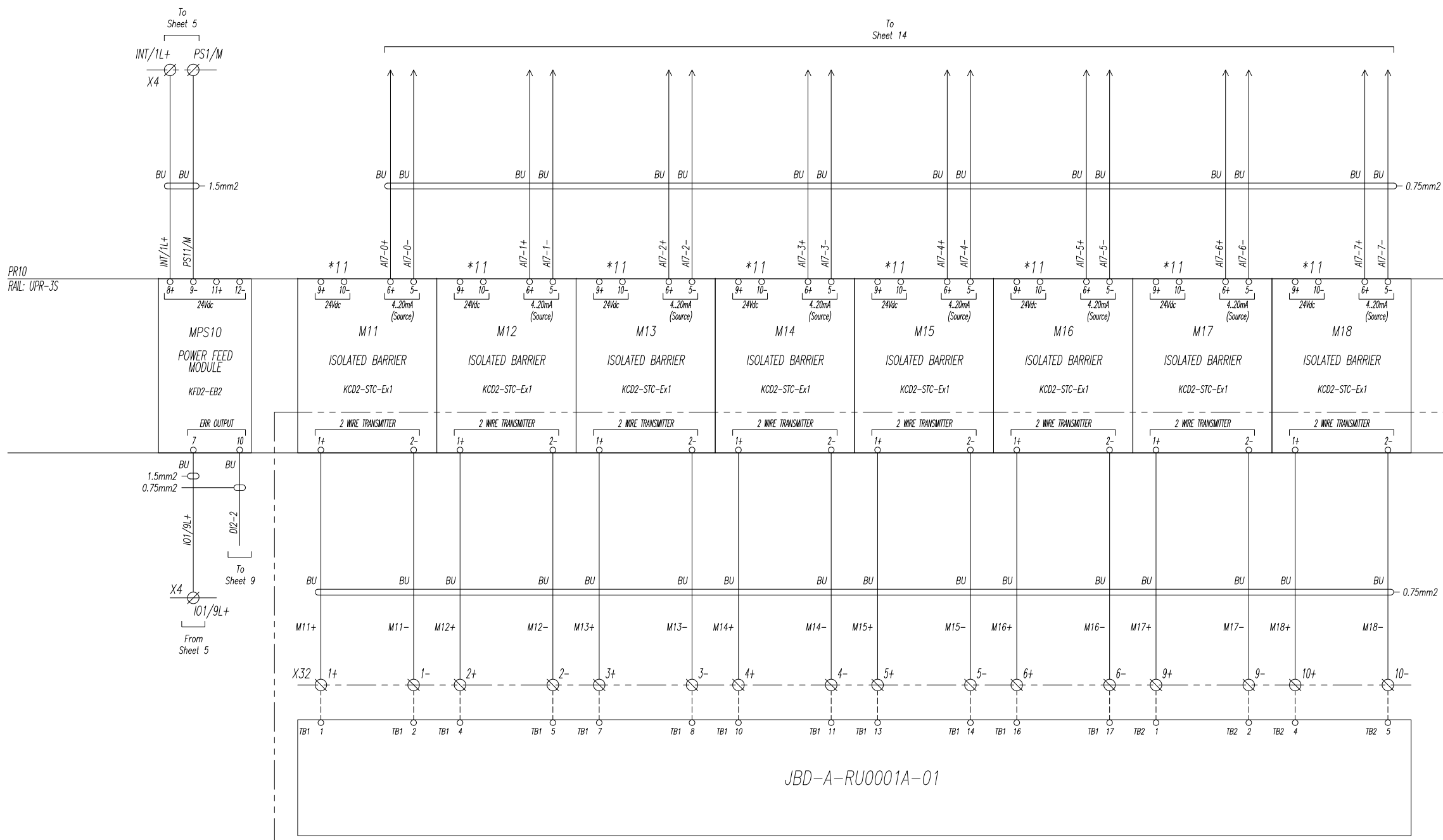

- COMPRESSOR SUCTION PRESSURE TRANSMITTER PIT-RU0001A-01
- DISCHARGE PRESSURE TRANSMITTER PIT-RU0001A-03
- UPSTREAM OIL FILTER PRESSURE TRANSMITTER PIT-RU0001A-05
- COMPRESSOR SUCTION TEMPERATURE TRANSMITTER TIT-RU0001A-01
- OIL HEADER COMPRESSOR PRESSURE TRANSMITTER PIT-RU0001A-02
- OIL SEPARATOR PRESSURE TRANSMITTER PIT-RU0001A-04
- DOWNSTREAM OIL FILTER PRESSURE TRANSMITTER PIT-RU0001A-06
- OIL HEADER COMPRESSOR TEMPERATURE TRANSMITTER TIT-RU0001A-02

NON-IS CIRCUIT
IS CIRCUIT

0	6/01/25	First Issue	SV	-	-
REV.	ISSUE DATE	DESCRIPTION	PREPARED	CHECKED	APPROVED
CLIENT:			CONSULTING ENGINEER:		
VENDOR:					
PROJECT: PR200					
DRAWING TITLE: PLC Wiring and Layout Drawing					
DRAWING NO. E1027-HSE-VD-IN-DIG-008			REV. R0	SIZE A3	SCALE NA
					SHEET 16/40

GENERAL NOTES

WIRE COLOR CODE (IEC 60757)

BK : BLACK

BN : BROWN

RD : RED

OG : ORANGE

GN : GREEN

BU : DARK BLUE

LB : LIGHT BLUE

GY : GREY

WH : WHITE

GNYE : GREEN AND YELLOW

SH : SCREENING METAL

WIRE MARKER

White heat shrink type with Black letter

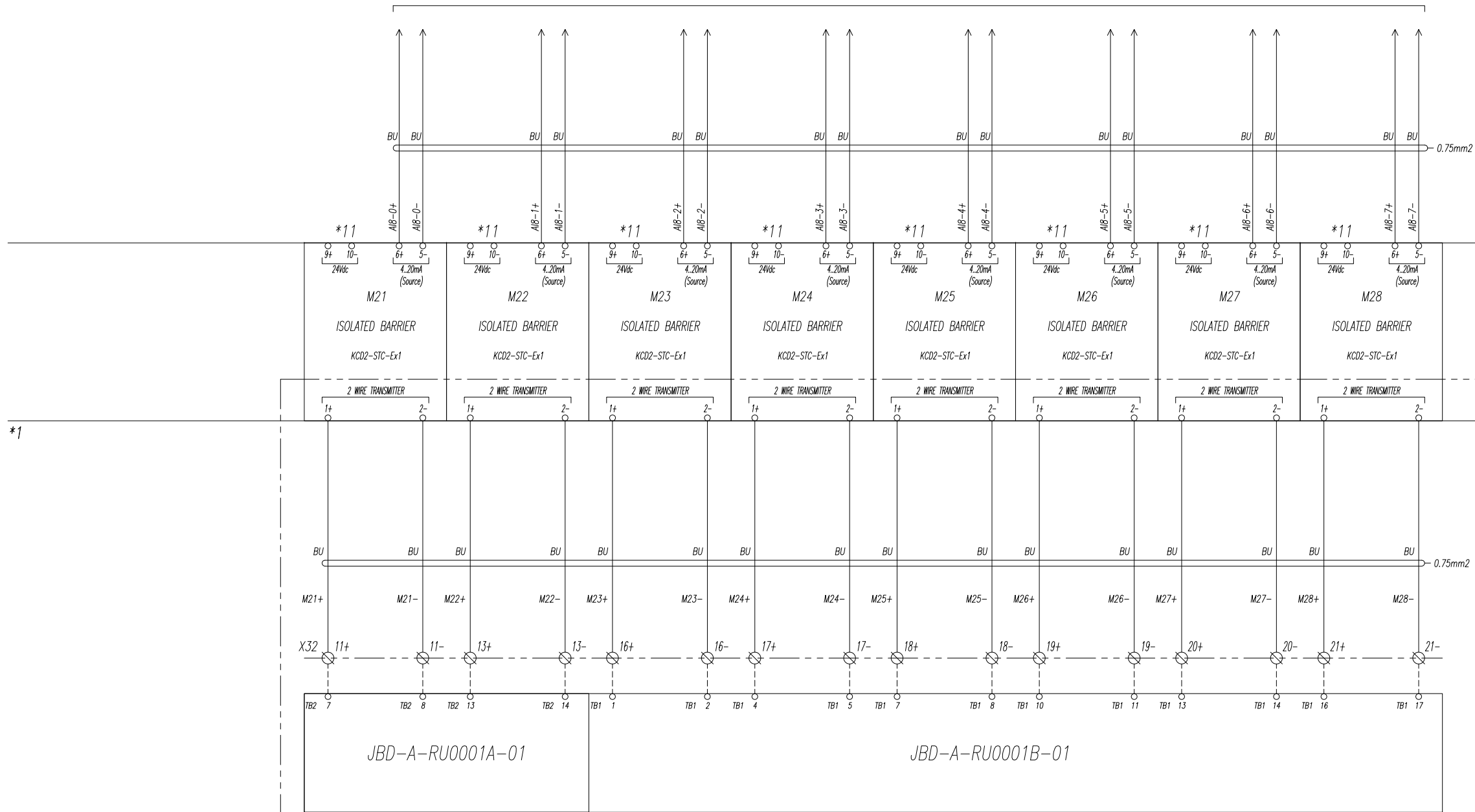

OIL SEPARATOR TEMPERATURE TRANSMITTER
TIT-RU0001A-03

COMPRESSOR SUCTION PRESSURE TRANSMITTER
PIT-RU0001B-01

DISCHARGE PRESSURE TRANSMITTER
PIT-RU0001B-03

UPSTREAM OIL FILTER PRESSURE TRANSMITTER
PIT-RU0001B-05

COMPRESSOR SLIDE VALVE POSITION TRANSMITTER
ZIT-RU0001A-01

OIL HEADER COMPRESSOR PRESSURE TRANSMITTER
PIT-RU0001B-02

OIL SEPARATOR PRESSURE TRANSMITTER
PIT-RU0001B-04

DOWNSTREAM OIL FILTER PRESSURE TRANSMITTER
PIT-RU0001B-06

NON-IS CIRCUIT
IS CIRCUIT

0	6/01/25	First Issue	SV	-	-	-
REV.	ISSUE DATE	DESCRIPTION	PREPARED	CHECKED	APPROVED	COMPANY
CLIENT:			CONSULTING ENGINEER:			
VENDOR:						
PROJECT: PR200						
DRAWING TITLE: PLC Wiring and Layout Drawing						
DRAWING NO. E1027-HSE-VD-IN-DIG-008			REV. R0	SIZE A3	SCALE NA	SHEET 17/40

GENERAL NOTES

WIRE COLOR CODE (IEC 60757)

- BK : BLACK
- BN : BROWN
- RD : RED
- OG : ORANGE
- GN : GREEN
- BU : DARK BLUE
- GB : GREY BLUE
- GY : GREY
- WY : WHITE
- WY : GREEN AND YELLOW
- SNY : SCREENING AND TALLOW
- SH : SCREENING METAL

WIRE MARKER

White heat shrink type with Black letter

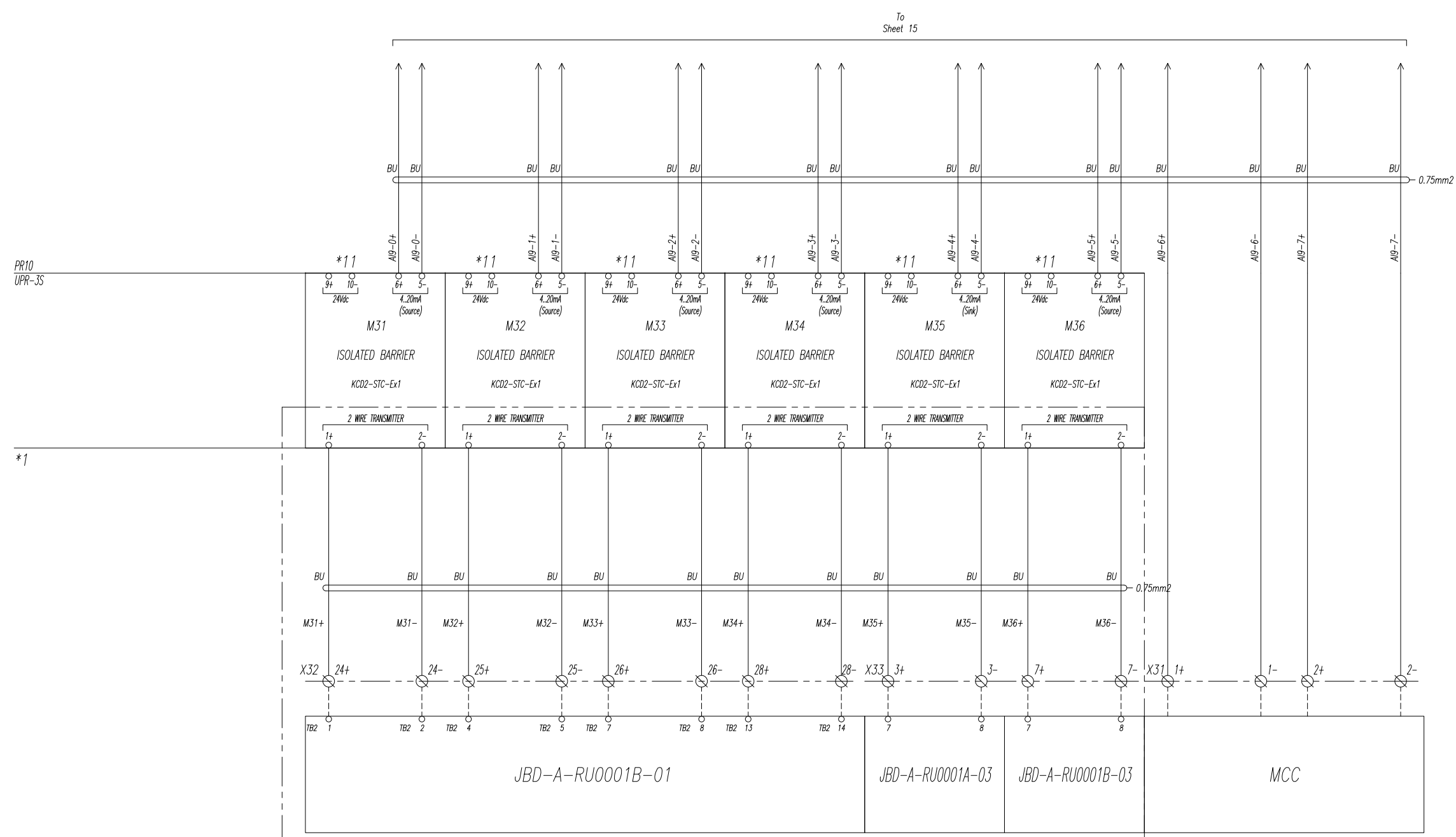

- COMPRESSOR SUCTION TEMPERATURE TRANSMITTER TIT-RU0001B-01
- OIL SEPARATOR TEMPERATURE TRANSMITTER TIT-RU0001B-03
- CHILLER A LIQUID LEVEL TRANSMITTER LIT-RU0001A-01
- COMPRESSOR A MOTOR AMPERAGE II-RU0001A-01
- OIL HEADER COMPRESSOR TEMPERATURE TRANSMITTER TIT-RU0001B-02
- COMPRESSOR SLIDE VALVE POSITION TRANSMITTER ZIT-RU0001B-01
- CHILLER B LIQUID LEVEL TRANSMITTER LIT-RU0001B-01
- COMPRESSOR B MOTOR AMPERAGE II-RU0001B-01

NON-IS CIRCUIT
IS CIRCUIT

*11: POWER SUPPLY FROM POWER RAIL

0	6/01/25	First Issue	SV	-	-
REV.	ISSUE DATE	DESCRIPTION	PREPARED	CHECKED	APPROVED
CLIENT:			CONSULTING ENGINEER:		
VENDOR:					
PROJECT: PR200					
DRAWING TITLE: PLC Wiring and Layout Drawing					
DRAWING NO. E1027-HSE-VD-IN-DIG-008			REV. R0	SIZE A3	SCALE NA
			SHEET 18	40	

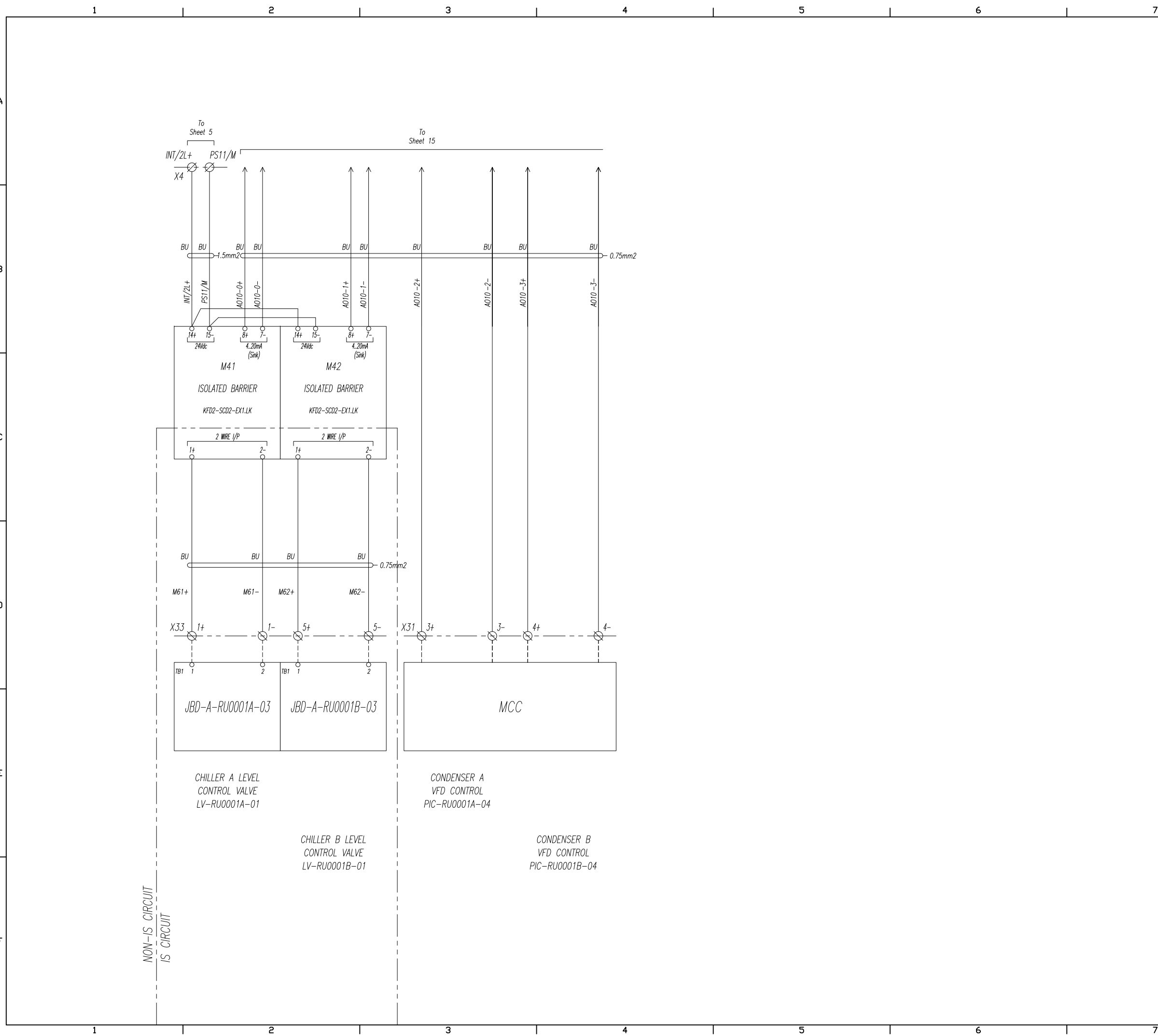

NON-IS CIRCUIT
IS CIRCUIT

GENERAL NOTES

WIRE COLOR CODE (IEC 60757)

- BK : BLACK
- BN : BROWN
- RD : RED
- OG : ORANGE
- GN : GREEN
- BU : DARK BLUE
- LB : LIGHT BLUE
- GY : GREY
- WH : WHITE
- GNYE : GREEN AND YELLOW
- SH : SCREENING METAL

WIRE MARKER

White heat shrink type with Black letter

0	6/01/25	First Issue	SV	-	-	-
REV.	ISSUE DATE	DESCRIPTION	PREPARED	CHECKED	APPROVED	COMPANY

CLIENT: _____ CONSULTING ENGINEER: _____

VENDOR: _____

PROJECT: **PR200**

DRAWING TITLE: **PLC Wiring and Layout Drawing**

DRAWING NO.	REV.	SIZE	SCALE	SHEET
E1027-HSE-VD-IN-DIG-008	RO	A3	NA	19/40

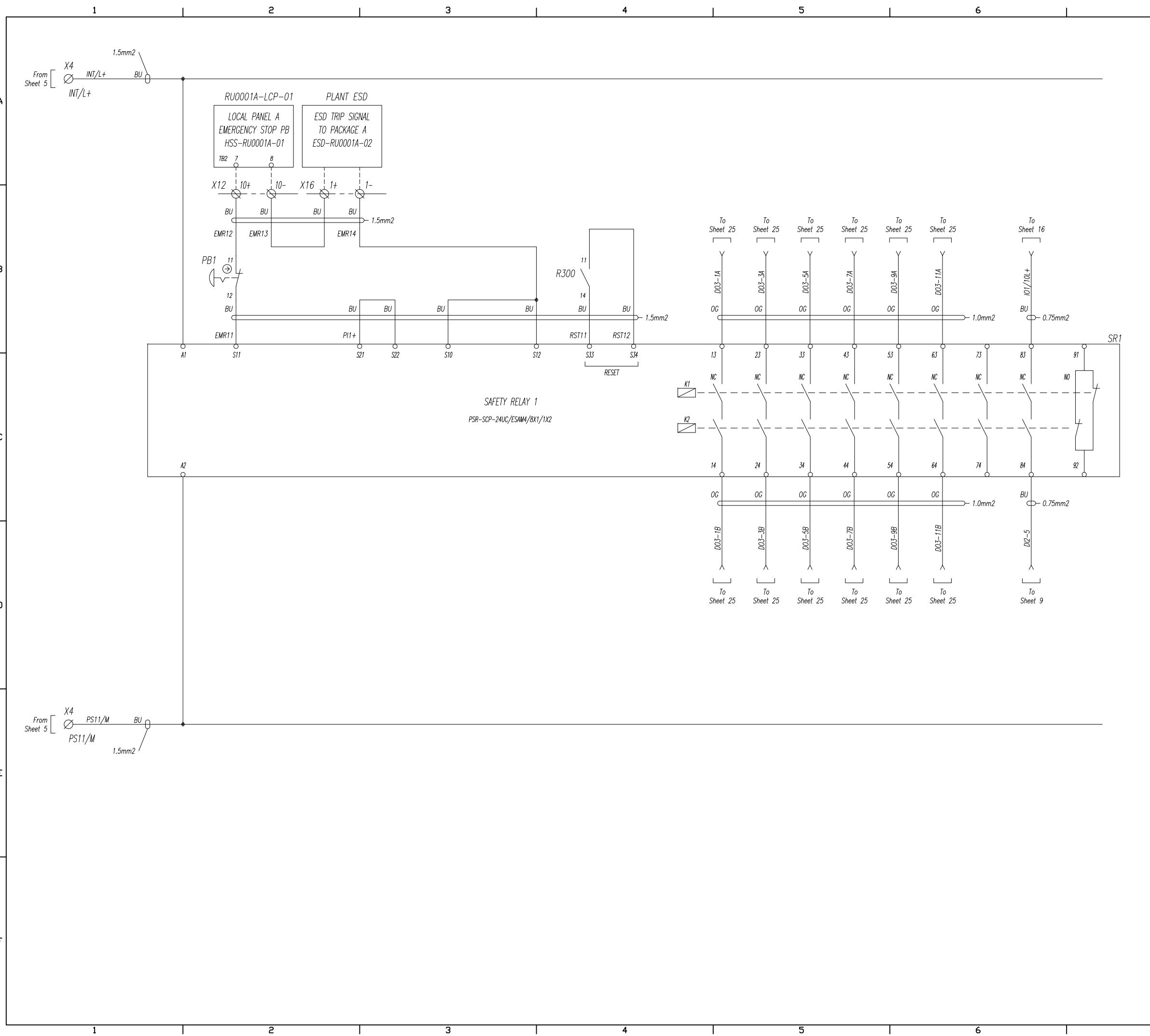

GENERAL NOTES

WIRE COLOR CODE (IEC 60757)

- BK : BLACK
- BN : BROWN
- RD : RED
- OG : ORANGE
- GN : GREEN
- BU : DARK BLUE
- LB : LIGHT BLUE
- GY : GREY
- WH : WHITE
- GNYE : GREEN AND YELLOW
- SH : SCREENING METAL

WIRE MARKER

White heat shrink type with Black letter

0	6/01/25	First issue	SV	-	-	-
REV.	ISSUE DATE	DESCRIPTION	PREPARED	CHECKED	APPROVED	COMPANY
CLIENT:			CONSULTING ENGINEER:			
VENDOR:						
PROJECT: PR200						
DRAWING TITLE: PLC Wiring and Layout Drawing						
DRAWING NO.			REV.	SIZE	SCALE	SHEET
E1027-HSE-VD-IN-DIG-008			R0	A3	NA	20/40

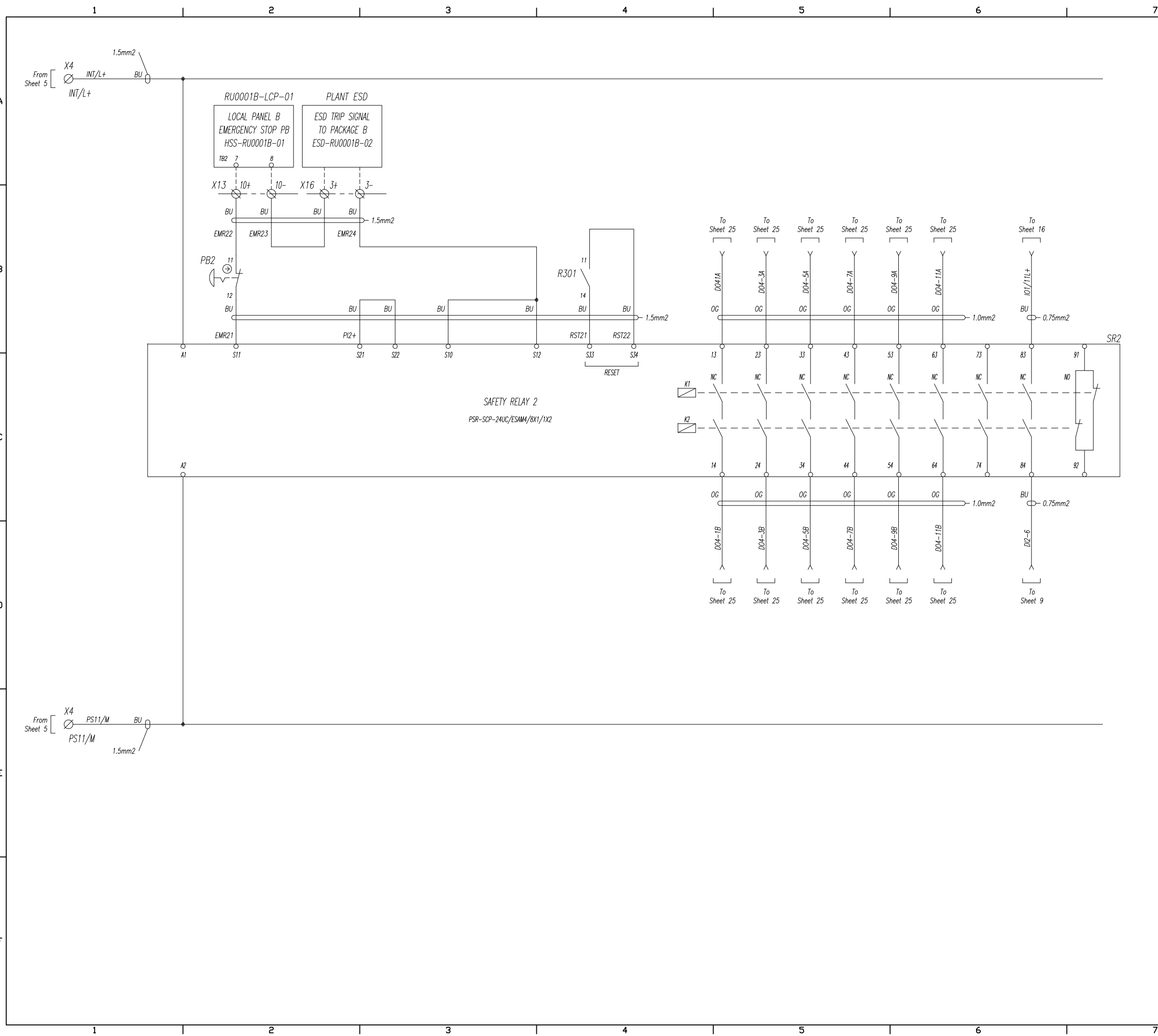

GENERAL NOTES

WIRE COLOR CODE (IEC 60757)

- BK : BLACK
- BN : BROWN
- RD : RED
- OG : ORANGE
- GN : GREEN
- BU : DARK BLUE
- LB : LIGHT BLUE
- GY : GREY
- WH : WHITE
- GNYE : GREEN AND YELLOW
- SH : SCREENING METAL

WIRE MARKER

White heat shrink type with Black letter

0	6/01/25	First Issue	SV	-	-
REV.	ISSUE DATE	DESCRIPTION	PREPARED	CHECKED	APPROVED
CLIENT:			CONSULTING ENGINEER:		
VENDOR:					
PROJECT: PR200					
DRAWING TITLE: PLC Wiring and Layout Drawing					
DRAWING NO. E1027-HSE-VD-IN-DIG-008			REV. R0	SIZE A3	SCALE NA
					SHEET 21/40

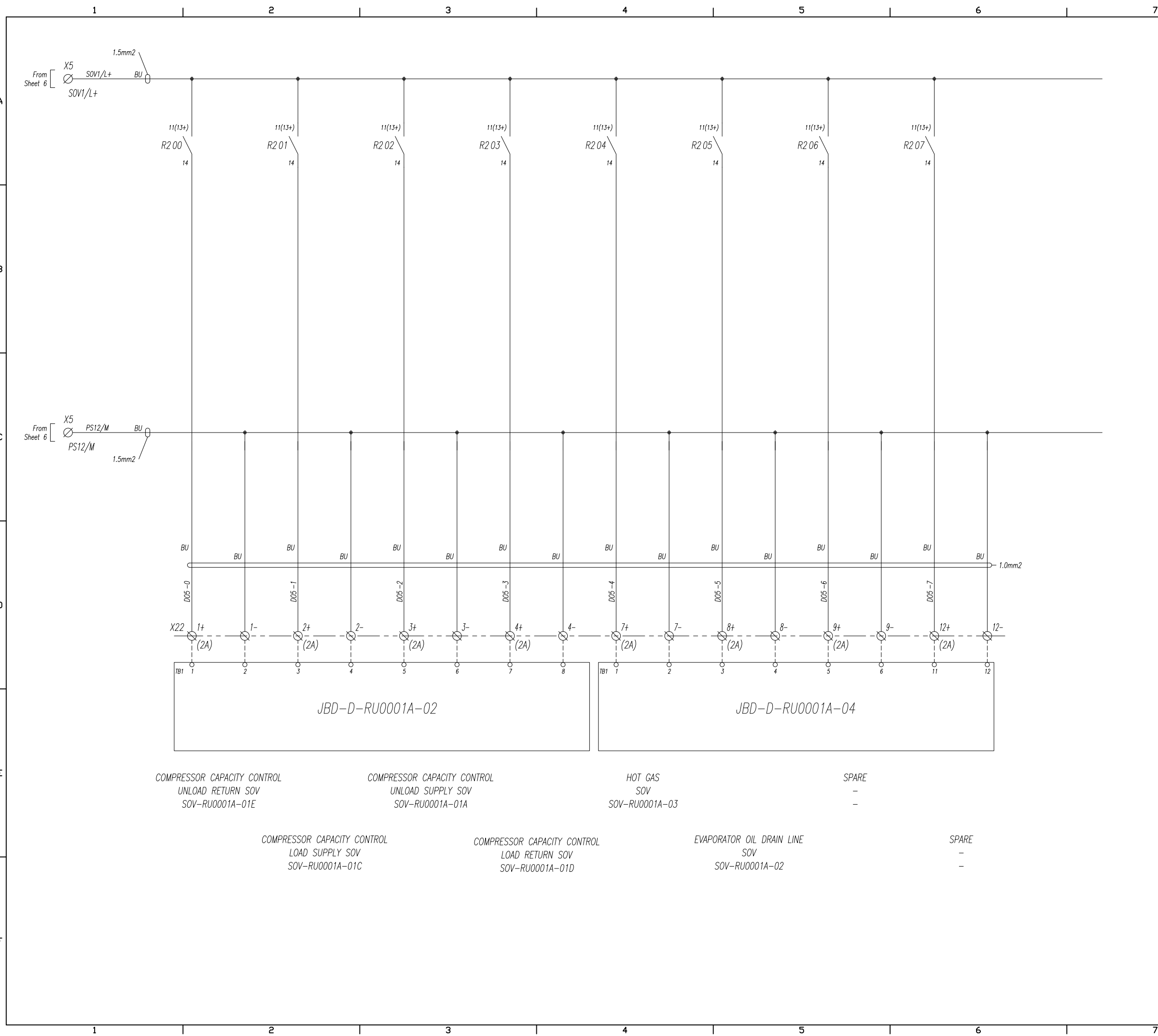

GENERAL NOTES

WIRE COLOR CODE (IEC 60757)
 BK : BLACK
 BN : BROWN
 RD : RED
 OG : ORANGE
 GN : GREEN
 BU : DARK BLUE
 LB : LIGHT BLUE
 GY : GREY
 WH : WHITE
 GNYE : GREEN AND YELLOW
 SH : SCREENING METAL

WIRE MARKER
 White heat shrink type with Black letter

0	6/01/25	First Issue	SV	-	-	-
REV.	ISSUE DATE	DESCRIPTION	PREPARED	CHECKED	APPROVED	COMPANY
CLIENT:			CONSULTING ENGINEER:			
VENDOR:						
PROJECT: PR200						
DRAWING TITLE: PLC Wiring and Layout Drawing						
DRAWING NO. E1027-HSE-VD-IN-DIG-008			REV. R0	SIZE A3	SCALE NA	SHEET 22/40

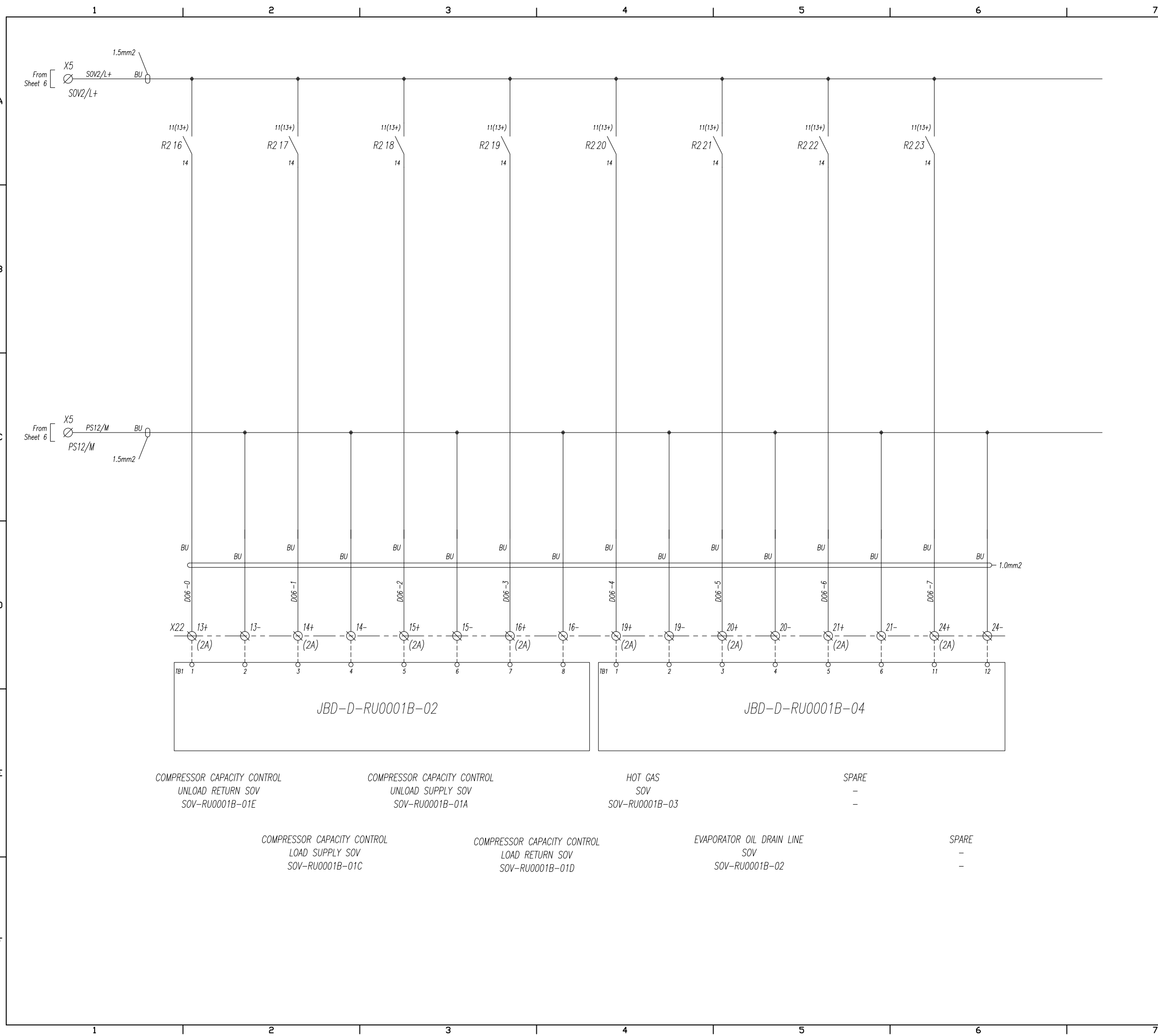

GENERAL NOTES

WIRE COLOR CODE (IEC 60757)
 BK : BLACK
 BN : BROWN
 RD : RED
 OG : ORANGE
 GN : GREEN
 BU : DARK BLUE
 LB : LIGHT BLUE
 GY : GREY
 WH : WHITE
 GNYE : GREEN AND YELLOW
 SH : SCREENING METAL

WIRE MARKER
 White heat shrink type with Black letter

COMPRESSOR CAPACITY CONTROL
 UNLOAD RETURN SOV
 SOV-RU0001B-01E

COMPRESSOR CAPACITY CONTROL
 UNLOAD SUPPLY SOV
 SOV-RU0001B-01A

HOT GAS
 SOV
 SOV-RU0001B-03

SPARE
 -
 -

COMPRESSOR CAPACITY CONTROL
 LOAD SUPPLY SOV
 SOV-RU0001B-01C

COMPRESSOR CAPACITY CONTROL
 LOAD RETURN SOV
 SOV-RU0001B-01D

EVAPORATOR OIL DRAIN LINE
 SOV
 SOV-RU0001B-02

SPARE
 -
 -

0	6/01/25	First Issue	SV	-	-	-
REV.	ISSUE DATE	DESCRIPTION	PREPARED	CHECKED	APPROVED	COMPANY
CLIENT:			CONSULTING ENGINEER:			
VENDOR:						
PROJECT: PR200						
DRAWING TITLE: PLC Wiring and Layout Drawing						
DRAWING NO. E1027-HSE-VD-IN-DIG-008			REV. R0	SIZE A3	SCALE NA	SHEET 23/40

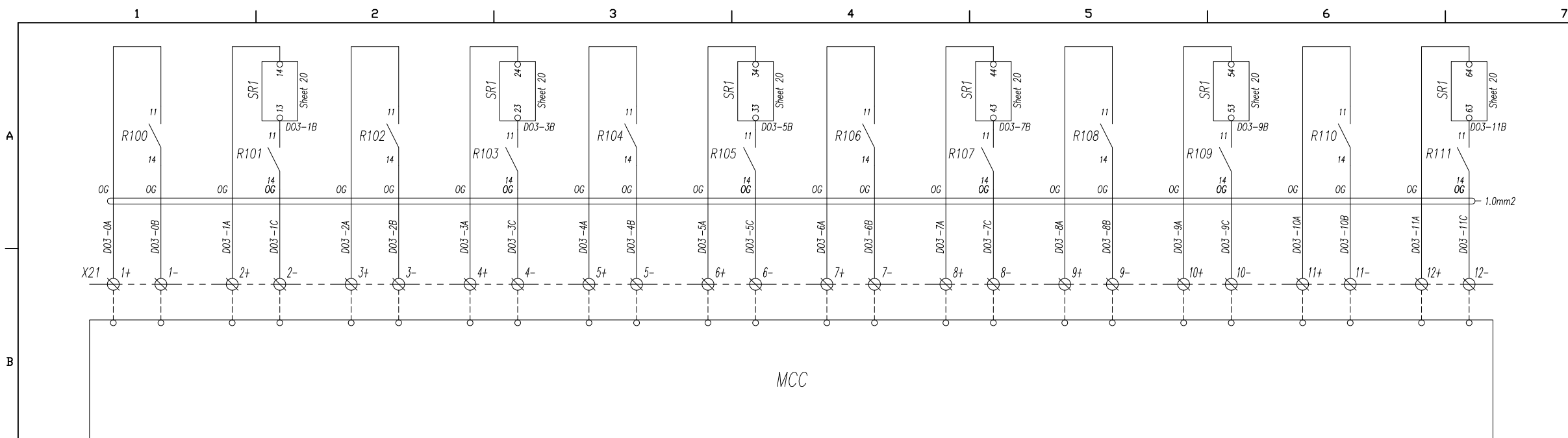

COMPRESSOR RU0001A-M-01 MOTOR START COMMAND XST-RU0001A-01 (Close pulse)	OIL PUMP RU0001A-P-01 MOTOR START COMMAND XST-RU0001A-02 (Close pulse)	SEPARATOR OIL HEATER RU0001A-H-01 ON COMMAND XS-RU0001A-01B (Close pulse)	SPARE -	CONDENSER MOTOR FAN 2 START COMMAND XST-RU0001A-03A (Close pulse)	CONDENSER MOTOR FAN 3 START COMMAND XST-RU0001A-03B (Close pulse)
COMPRESSOR RU0001A-M-01 MOTOR STOP COMMAND XSP-RU0001A-01 (Open pulse)	OIL PUMP RU0001A-P-01 MOTOR STOP COMMAND XSP-RU0001A-02 (Open pulse)	SEPARATOR OIL HEATER RU0001A-H-01 OFF COMMAND XS-RU0001A-01C (Open pulse)	SPARE -	CONDENSER MOTOR FAN 2 STOP COMMAND XSP-RU0001A-03A (Open pulse)	CONDENSER MOTOR FAN 3 STOP COMMAND XST-RU0001A-03B (Open pulse)

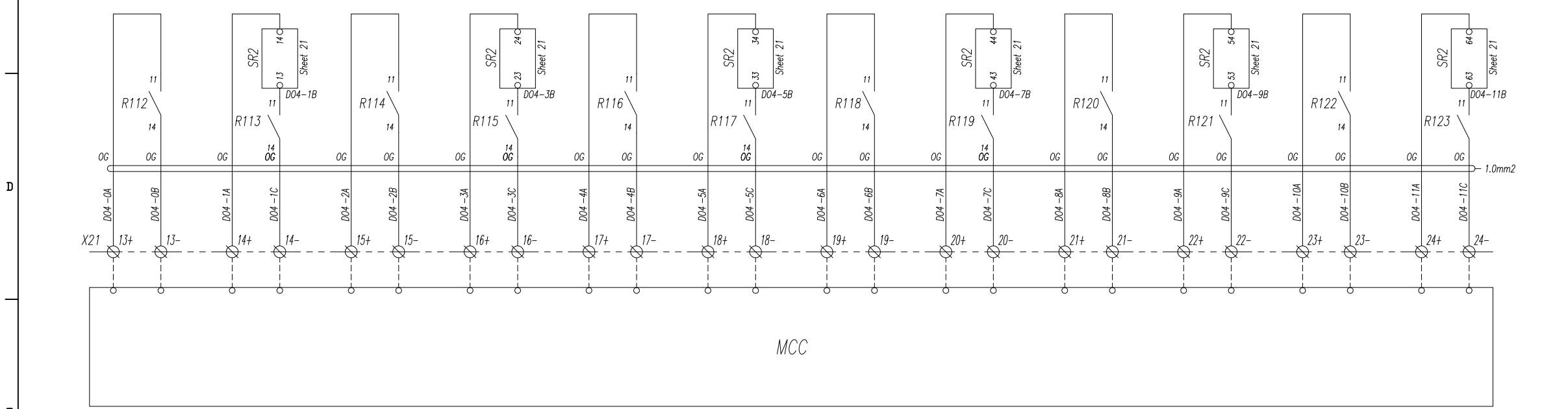

COMPRESSOR RU0001B-M-01 START COMMAND XST-RU0001B-01 (Close pulse)	OIL PUMP RU0001B-P-01 MOTOR START COMMAND XST-RU0001B-02 (Close pulse)	SEPARATOR OIL HEATER RU0001B-H-01 ON COMMAND XS-RU0001B-01B (Close pulse)	SPARE -	CONDENSER MOTOR FAN 2 START COMMAND XST-RU0001B-03A (Close pulse)	CONDENSER MOTOR FAN 3 START COMMAND XST-RU0001B-03B (Close pulse)
COMPRESSOR RU0001B-M-01 STOP COMMAND XSP-RU0001B-01 (Open pulse)	OIL PUMP RU0001B-P-01 MOTOR STOP COMMAND XSP-RU0001B-02 (Open pulse)	SEPARATOR OIL HEATER RU0001B-H-01 OFF COMMAND XS-RU0001B-01C (Open pulse)	SPARE -	CONDENSER MOTOR FAN 2 STOP COMMAND XSP-RU0001B-03A (Open pulse)	CONDENSER MOTOR FAN 3 STOP COMMAND XST-RU0001B-03B (Open pulse)

GENERAL NOTES

WIRE COLOR CODE (IEC 60757)
 BK : BLACK
 BN : BROWN
 RD : RED
 OG : ORANGE
 GN : GREEN
 BU : DARK BLUE
 LB : LIGHT BLUE
 GY : GREY
 WH : WHITE
 GNYE : GREEN AND YELLOW
 SH : SCREENING METAL

WIRE MARKER
 White heat shrink type with Black letter

0	6/01/25	First Issue	SV	-	-	-
REV.	ISSUE DATE	DESCRIPTION	PREPARED	CHECKED	APPROVED	COMPANY
CLIENT:			CONSULTING ENGINEER:			
VENDOR:						
PROJECT: PR200						
DRAWING TITLE: PLC Wiring and Layout Drawing						
DRAWING NO. E1027-HSE-VD-IN-DIG-008			REV. RO	SIZE A3	SCALE NA	SHEET 26/40

GENERAL NOTES

WIRE COLOR CODE (IEC 60757)

BK : BLACK

BN : BROWN

RD : RED

OG : ORANGE

GN : GREEN

BU : DARK BLUE

LB : LIGHT BLUE

GY : GREY

WH : WHITE

GNYE : GREEN AND YELLOW

SH : SCREENING METAL

WIRE MARKER

White heat shrink type with Black letter

0	6/01/25	First Issue	SV	-	-	-
---	---------	-------------	----	---	---	---

REV.	ISSUE DATE	DESCRIPTION	PREPARED	CHECKED	APPROVED	COMPANY
------	------------	-------------	----------	---------	----------	---------

CLIENT:	CONSULTING ENGINEER:

VENDOR:

PROJECT: **PR200**

DRAWING TITLE:

PLC Wiring and Layout Drawing

DRAWING NO.	REV.	SIZE	SCALE	SHEET
E1027-HSE-VD-IN-DIG-008	R0	A3	NA	27/40

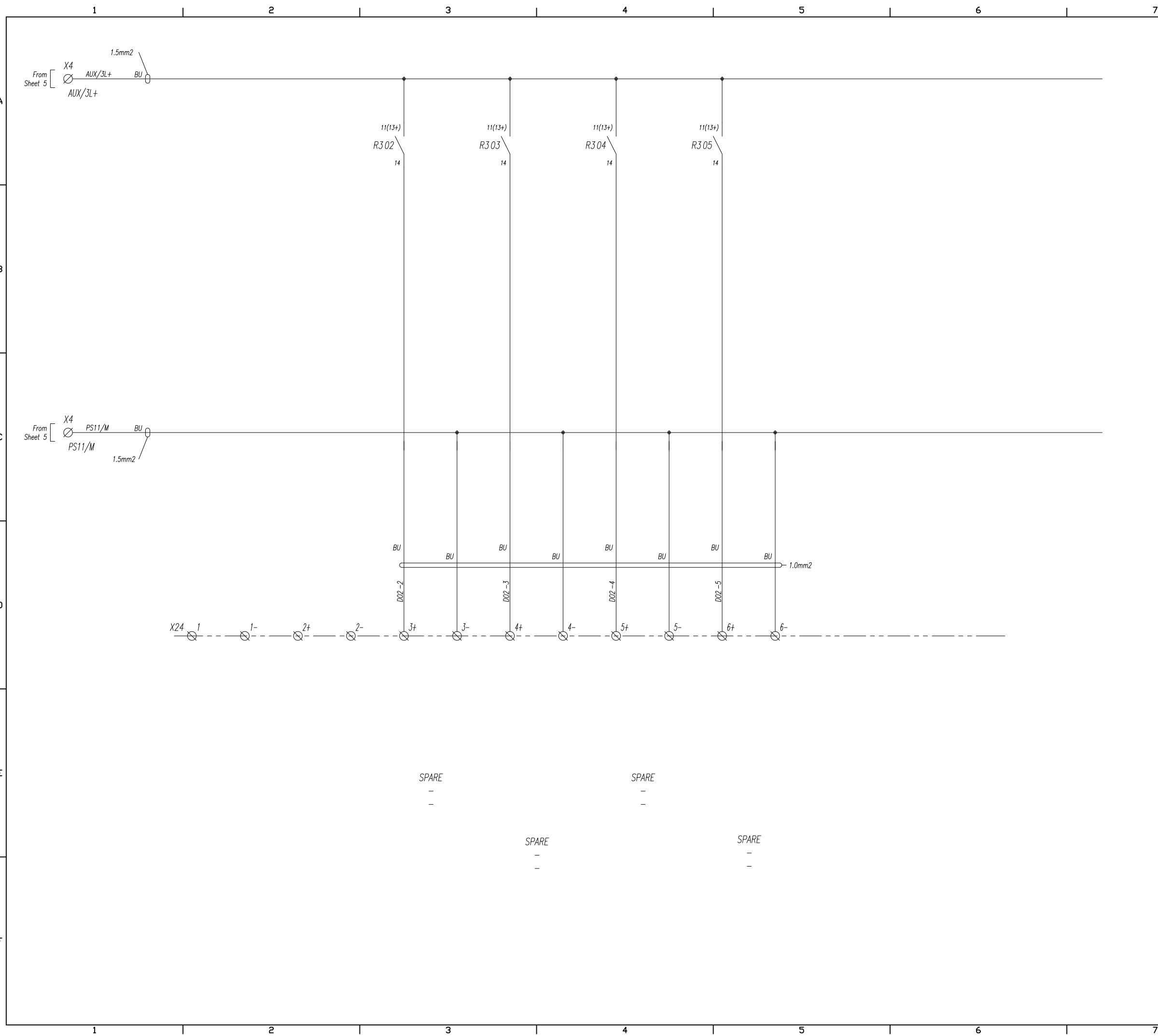

GENERAL NOTES

WIRE COLOR CODE (IEC 60757)

- BK : BLACK
- BN : BROWN
- RD : RED
- OG : ORANGE
- GN : GREEN
- BU : DARK BLUE
- LB : LIGHT BLUE
- GY : GREY
- WH : WHITE
- GNYE : GREEN AND YELLOW
- SH : SCREENING METAL

WIRE MARKER

White heat shrink type with Black letter

0	6/01/25	First Issue	SV	-	-	-
REV.	ISSUE DATE	DESCRIPTION	PREPARED	CHECKED	APPROVED	COMPANY
CLIENT:			CONSULTING ENGINEER:			
VENDOR:						
PROJECT: PR200						
DRAWING TITLE: PLC Wiring and Layout Drawing						
DRAWING NO. E1027-HSE-VD-IN-DIG-008			REV. RO	SIZE A3	SCALE NA	SHEET 28/40

1 UCP-RU0001

2 UCP-RU0001

5 UCP-RU0001

8 GENERAL NOTES

INTERNAL USE TERMINALS

INTERNAL USE TERMINALS

X1

INCOMING POWER UPS
110Vac/50Hz L+N

INCOMING POWER non-UPS
230Vac/50Hz L+N

PROTECTIVE EARTH

INSTRUMENT EARTH

INTRINSIC SAFETY EARTH

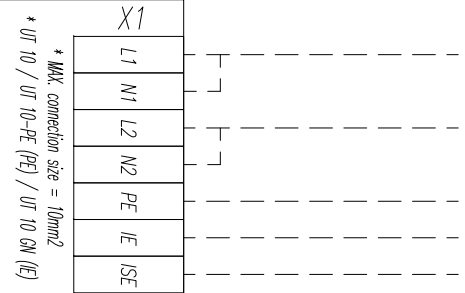
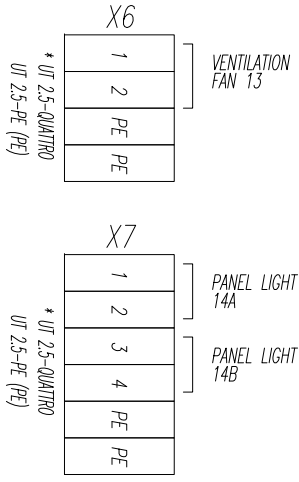
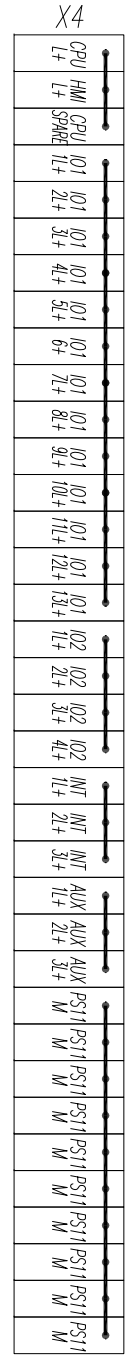

* UT 4-QUANTRO

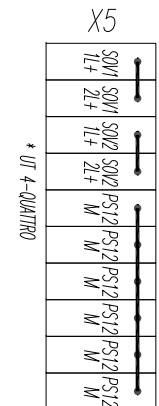

*1 : Estimated cable size, quantities and type for design

0	6/01/25	First issue	SV	-	-	-
REV.	ISSUE DATE	DESCRIPTION	PREPARED	CHECKED	APPROVED	COMPANY
CLIENT:			CONSULTING ENGINEER:			
VENDOR:						
PROJECT: PR200						
DRAWING TITLE: PLC Wiring and Layout Drawing						
DRAWING NO. E1027-HSE-VD-IN-DIG-008			REV. RO	SIZE A3	SCALE NA	SHEET 29/40

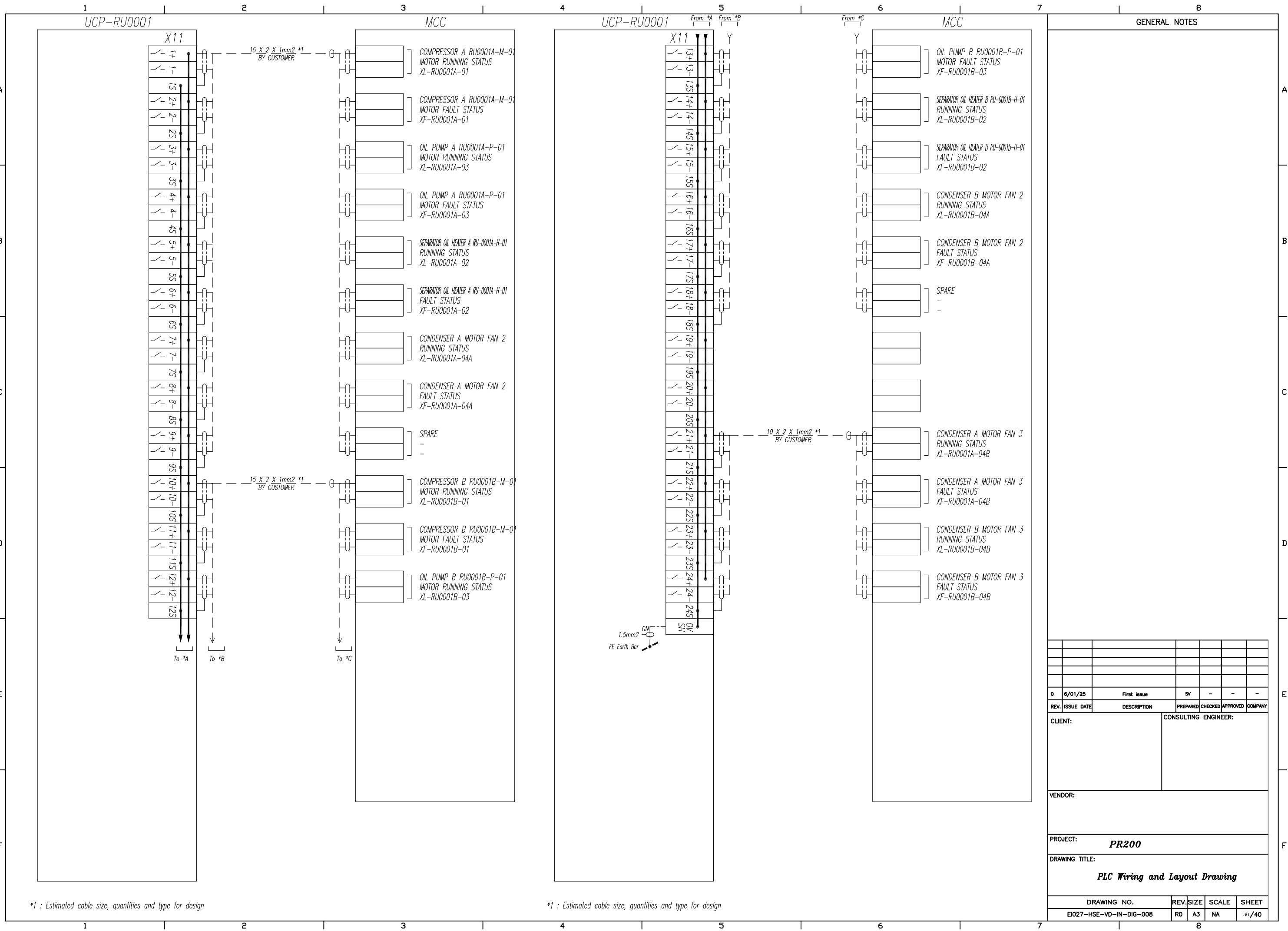

*1 : Estimated cable size, quantities and type for design

*1 : Estimated cable size, quantities and type for design

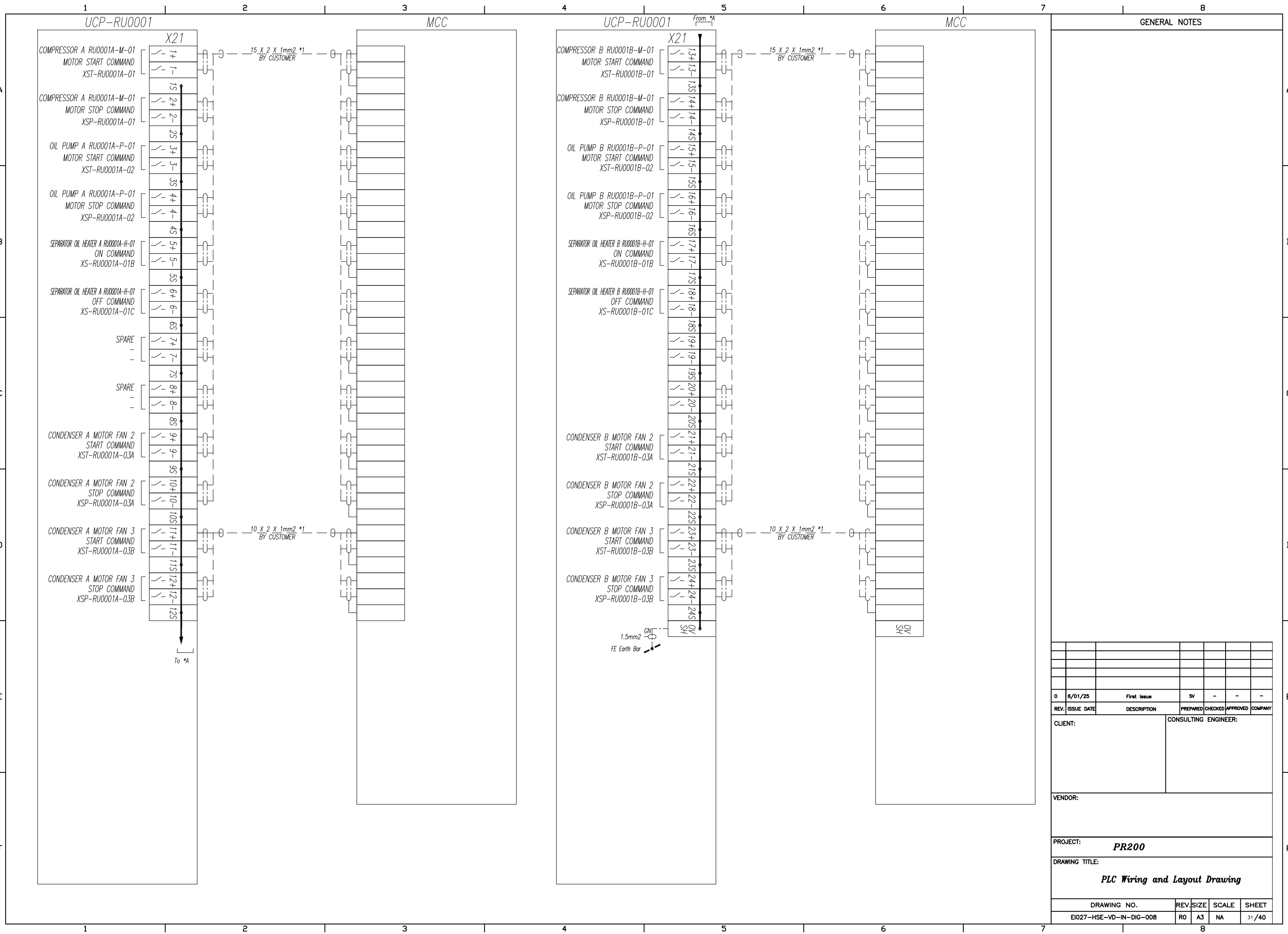

GENERAL NOTES

0	6/01/25	First Issue	SV	-	-	-
REV.	ISSUE DATE	DESCRIPTION	PREPARED	CHECKED	APPROVED	COMPANY
CLIENT:			CONSULTING ENGINEER:			
VENDOR:						
PROJECT: PR200						
DRAWING TITLE: PLC Wiring and Layout Drawing						
DRAWING NO. E1027-HSE-VD-IN-DIG-008			REV. R0	SIZE A3	SCALE NA	SHEET 31/40

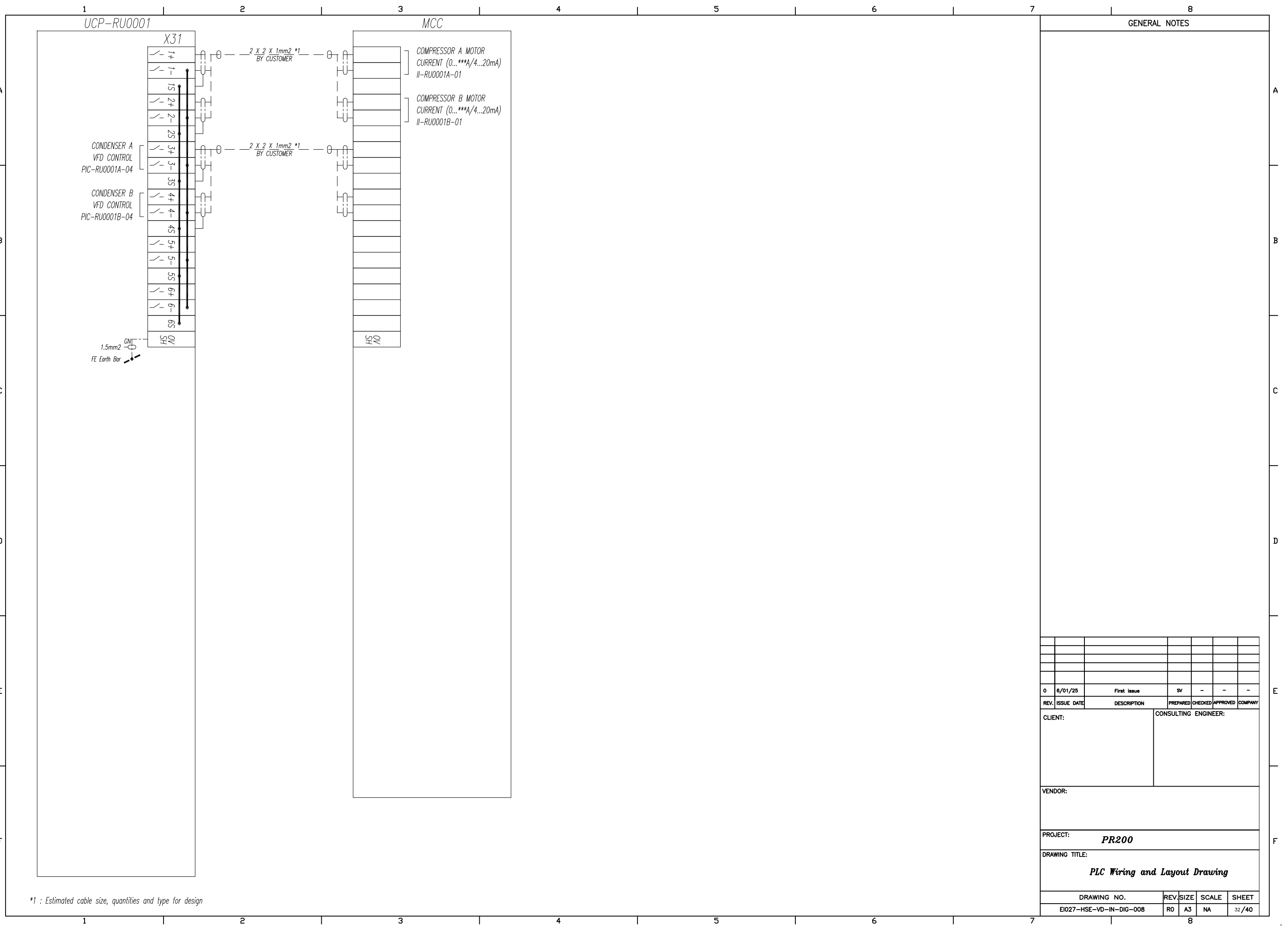

GENERAL NOTES

0	6/01/25	First issue	SV	-	-	-
REV.	ISSUE DATE	DESCRIPTION	PREPARED	CHECKED	APPROVED	COMPANY

CLIENT: _____ CONSULTING ENGINEER: _____

VENDOR: _____

PROJECT: **PR200**

DRAWING TITLE: **PLC Wiring and Layout Drawing**

DRAWING NO.	REV.	SIZE	SCALE	SHEET
E1027-HSE-VD-IN-DIG-008	R0	A3	NA	32/40

*1 : Estimated cable size, quantities and type for design

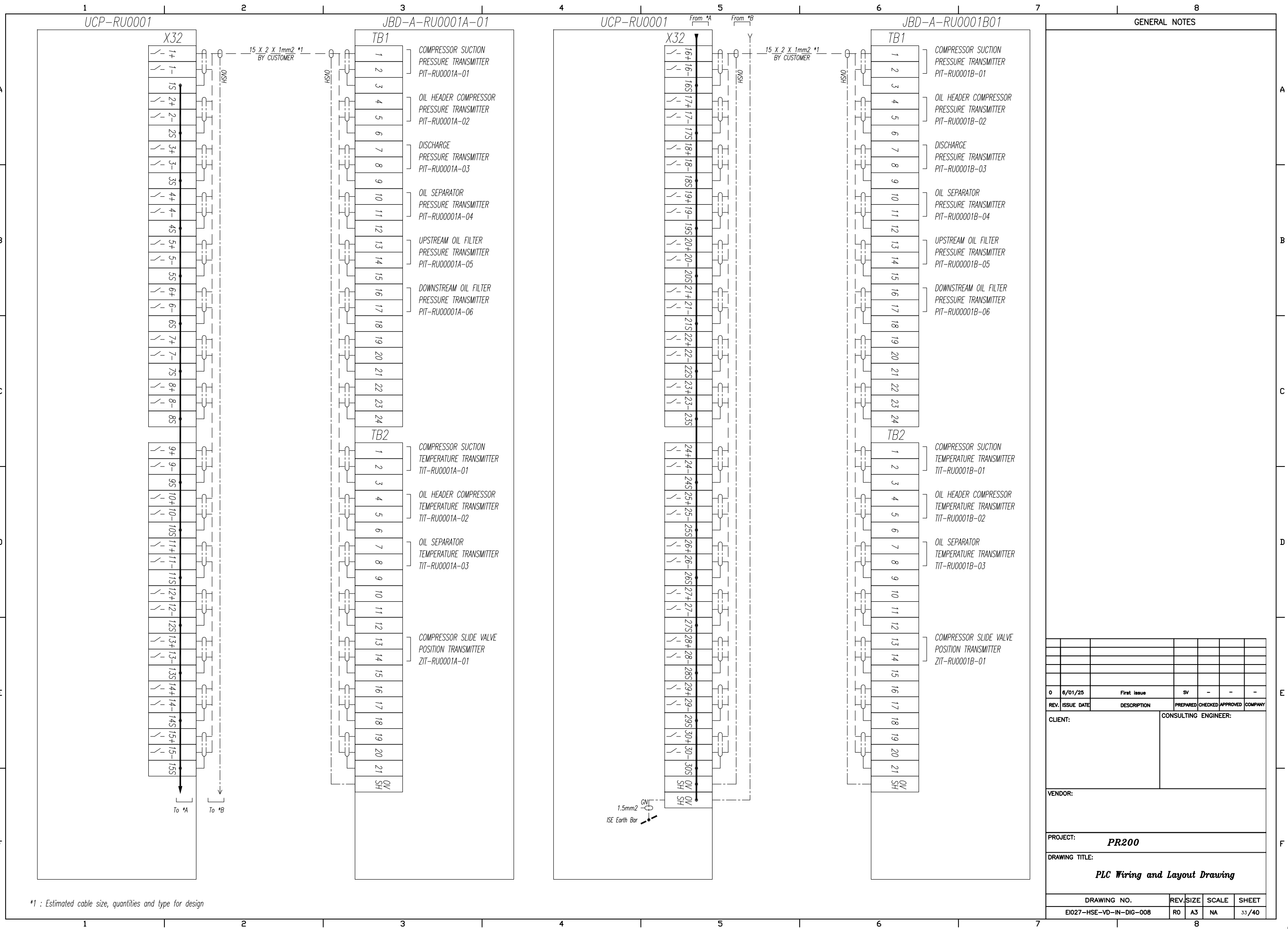

GENERAL NOTES

0	6/01/25	First Issue	SV	-	-	-
REV.	ISSUE DATE	DESCRIPTION	PREPARED	CHECKED	APPROVED	COMPANY
CLIENT:			CONSULTING ENGINEER:			
VENDOR:						
PROJECT: PR200						
DRAWING TITLE: PLC Wiring and Layout Drawing						
DRAWING NO.			REV.	SIZE	SCALE	SHEET
E1027-HSE-VD-IN-DIG-008			R0	A3	NA	33/40

*1 : Estimated cable size, quantities and type for design

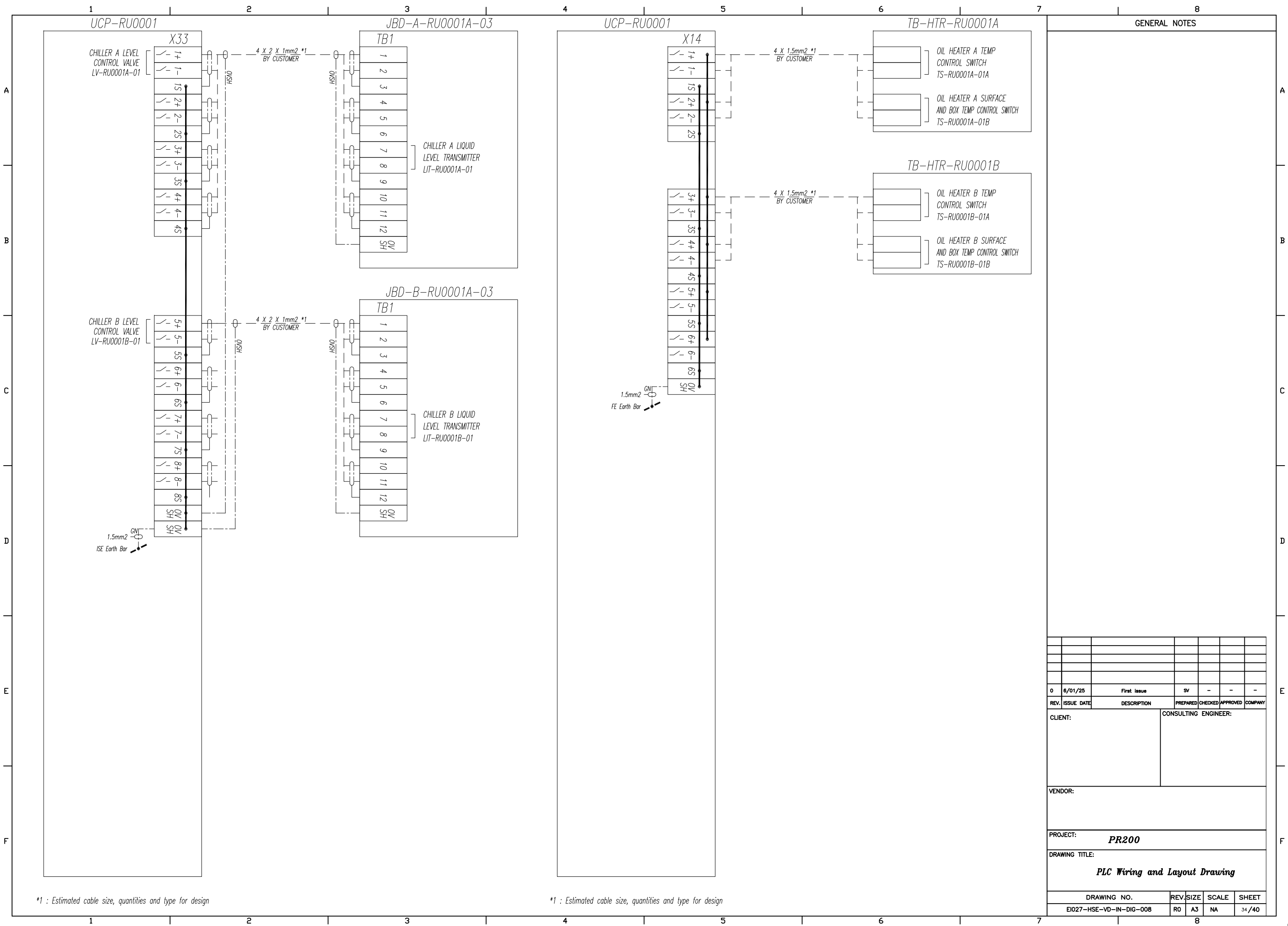

REV.	ISSUE DATE	DESCRIPTION	PREPARED	CHECKED	APPROVED	COMPANY
0	6/01/25	First Issue	SV	-	-	-

CLIENT: _____ CONSULTING ENGINEER: _____

VENDOR: _____

PROJECT: **PR200**

DRAWING TITLE: **PLC Wiring and Layout Drawing**

DRAWING NO.	REV.	SIZE	SCALE	SHEET
E1027-HSE-VD-IN-DIG-008	R0	A3	NA	34/40

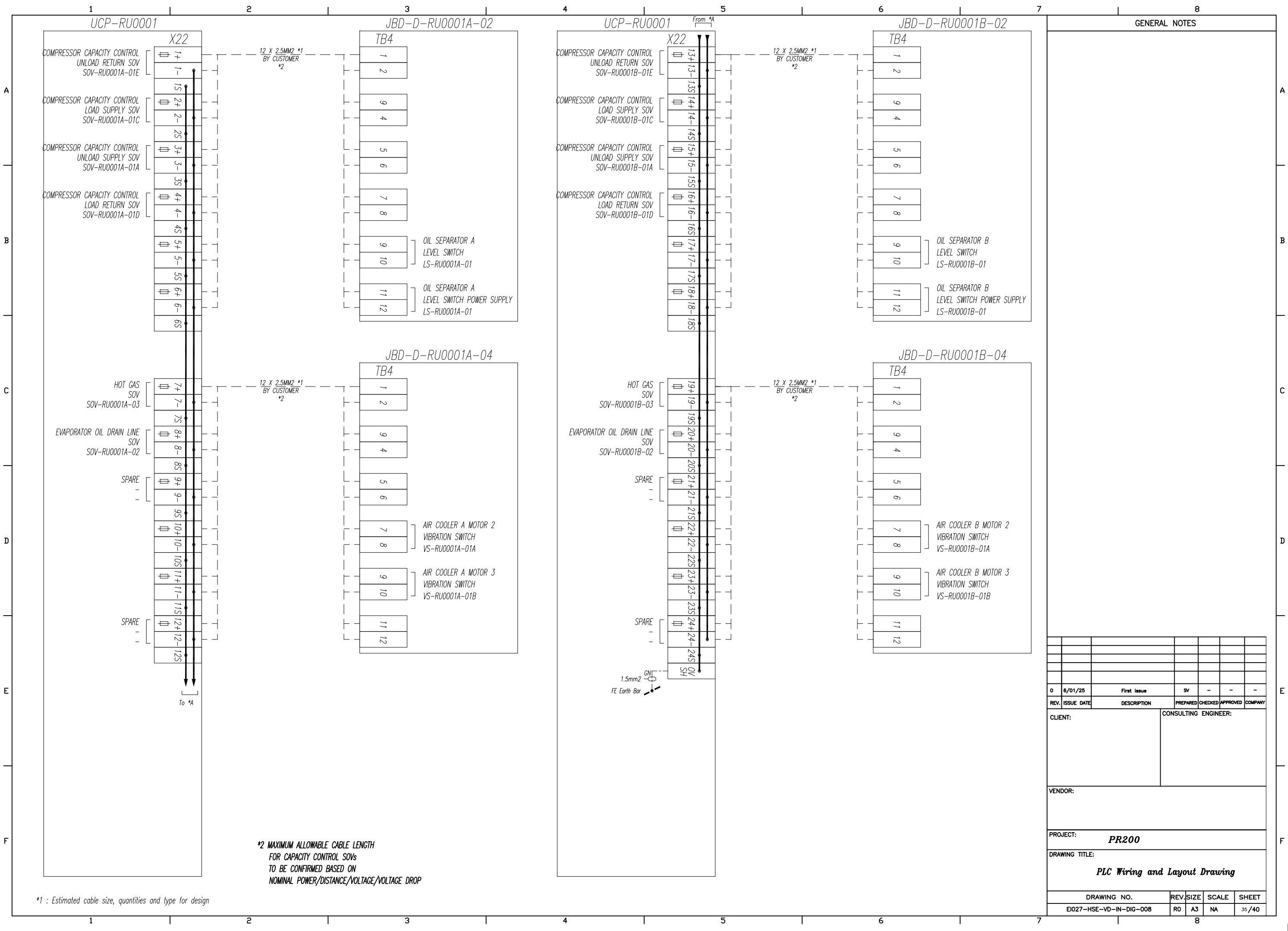

GENERAL NOTES

0	6/01/25	First Issue	SV	-	-
REV.	ISSUE DATE	DESCRIPTION	PREPARED	CHECKED	APPROVED
CLIENT:			CONSULTING ENGINEER:		
VENDOR:					
PROJECT: PR200					
DRAWING TITLE: PLC Wiring and Layout Drawing					
DRAWING NO.		REV.	SIZE	SCALE	SHEET
E1027-HSE-VD-IN-DIG-008		R0	A3	NA	35/40

*1 : Estimated cable size, quantities and type for design

*2 MAXIMUM ALLOWABLE CABLE LENGTH FOR CAPACITY CONTROL SOVs TO BE CONFIRMED BASED ON NOMINAL POWER/DISTANCE/VOLTAGE/VOLTAGE DROP

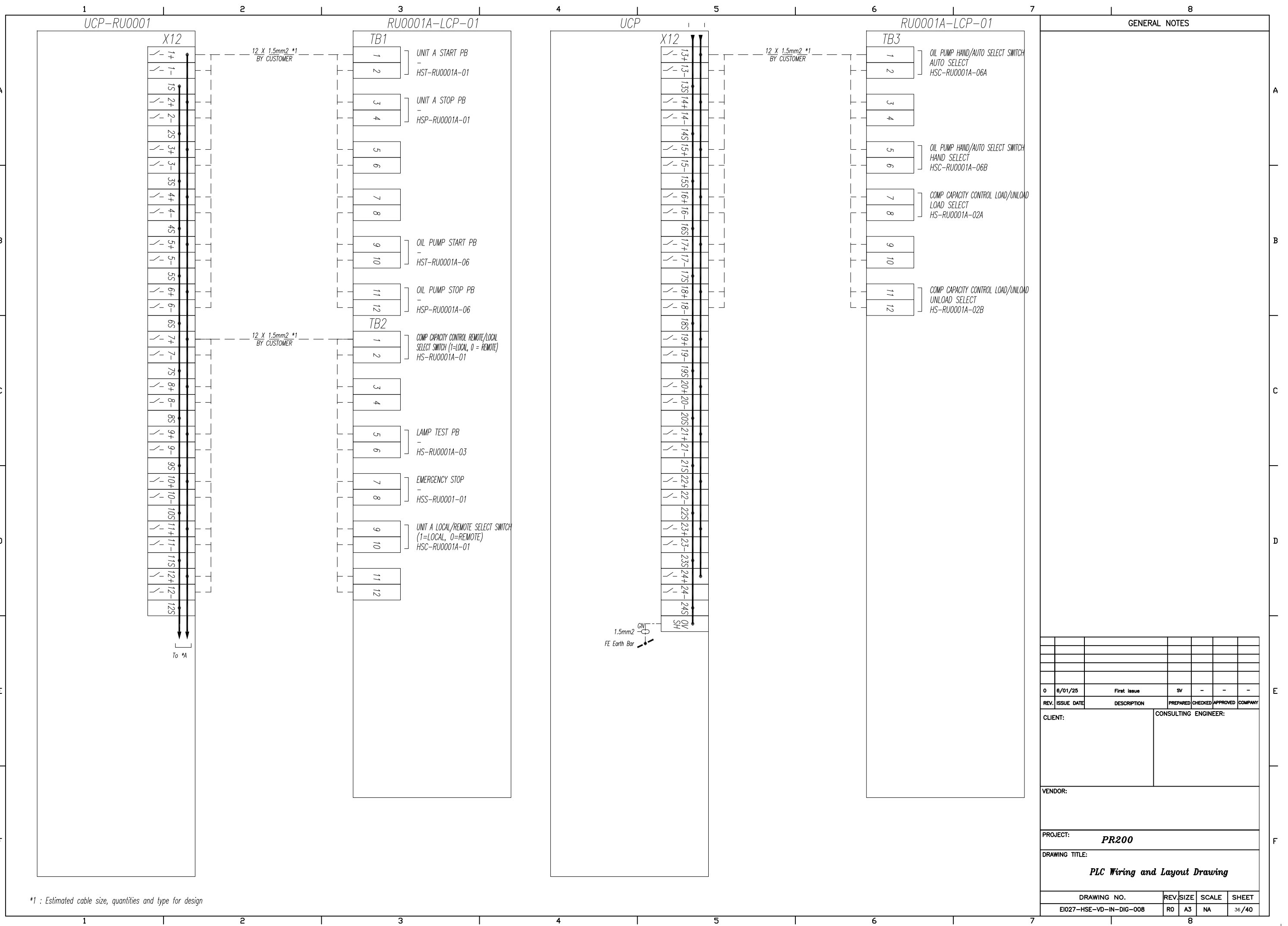

*1 : Estimated cable size, quantities and type for design

REV.	ISSUE DATE	DESCRIPTION	PREPARED	CHECKED	APPROVED	COMPANY
0	6/01/25	First Issue	SV	-	-	-
CLIENT:			CONSULTING ENGINEER:			
VENDOR:						
PROJECT: PR200						
DRAWING TITLE: PLC Wiring and Layout Drawing						
DRAWING NO. E1027-HSE-VD-IN-DIG-008			REV. R0	SIZE A3	SCALE NA	SHEET 36/40

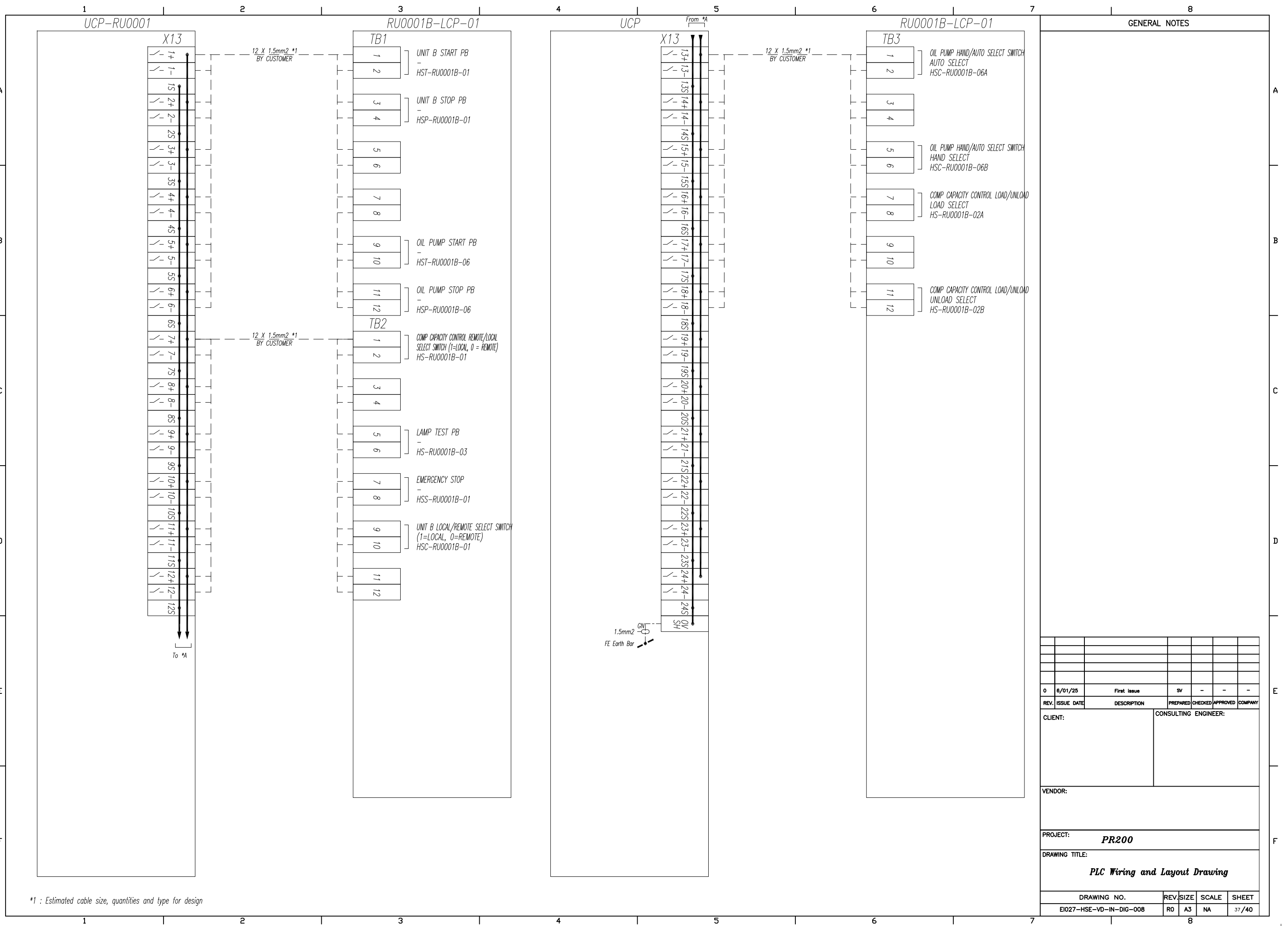

*1 : Estimated cable size, quantities and type for design

REV.	ISSUE DATE	DESCRIPTION	PREPARED	CHECKED	APPROVED	COMPANY
0	6/01/25	First Issue	SV	-	-	-

CLIENT: _____ CONSULTING ENGINEER: _____

VENDOR: _____

PROJECT: **PR200**

DRAWING TITLE: **PLC Wiring and Layout Drawing**

DRAWING NO.	REV.	SIZE	SCALE	SHEET
E1027-HSE-VD-IN-DIG-008	R0	A3	NA	37/40

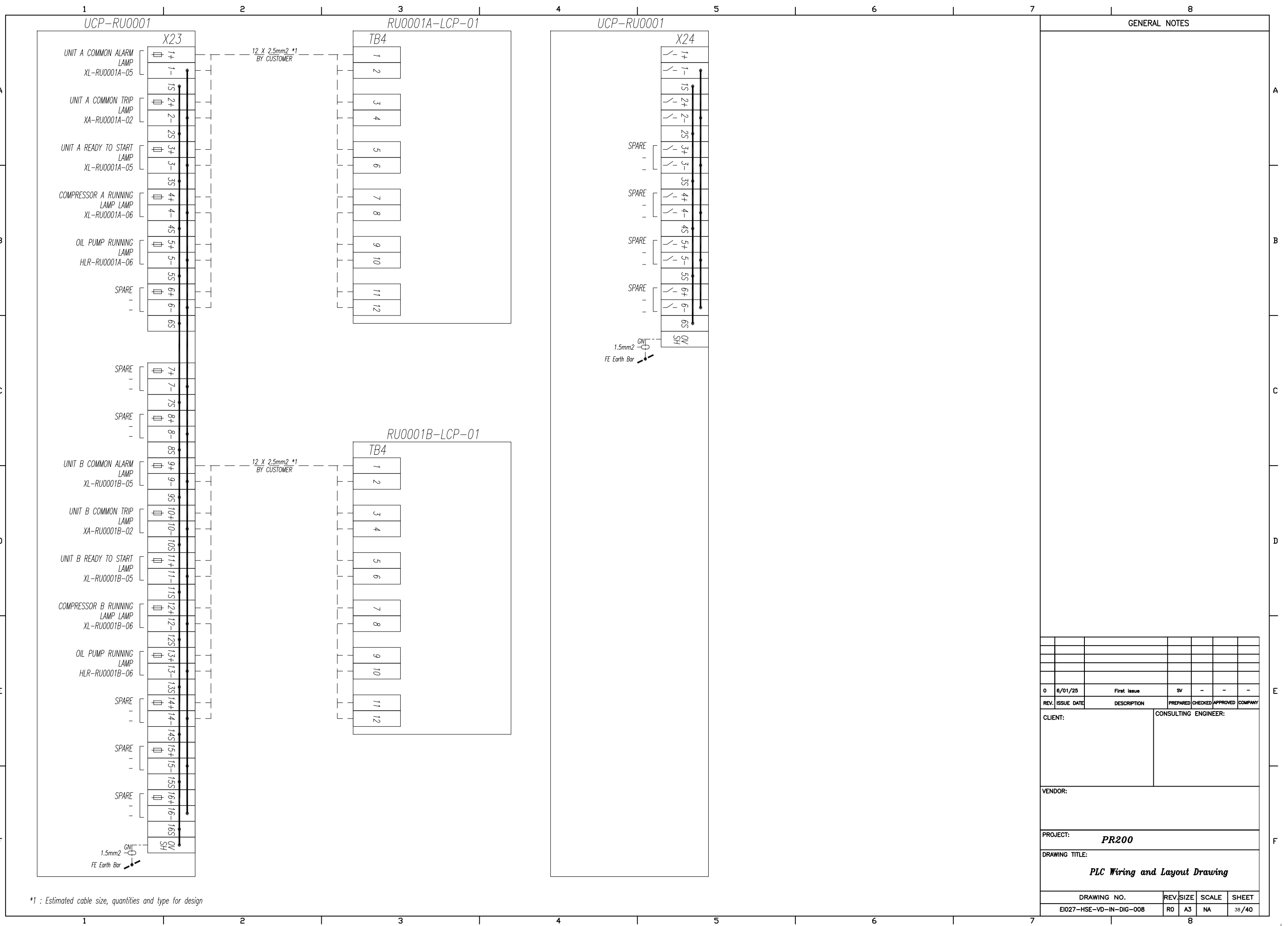

GENERAL NOTES

REV.	ISSUE DATE	DESCRIPTION	PREPARED	CHECKED	APPROVED	COMPANY
0	6/01/25	First issue	SV	-	-	-
CLIENT:			CONSULTING ENGINEER:			
VENDOR:						
PROJECT: PR200						
DRAWING TITLE: PLC Wiring and Layout Drawing						
DRAWING NO. E1027-HSE-VD-IN-DIG-008			REV. RO	SIZE A3	SCALE NA	SHEET 38/40

*1 : Estimated cable size, quantities and type for design

NO.	TAG NO.	INSTRUMENT/PARTS NAME	SPEC/SERVICE	MANUFACTURER	MODEL/CODE	QTY.	REMARKS
1	MCB10, MCB20	MINIATURE CIRCUIT BREAKER	2P/400VAC/60VDC/10kA/16AT-C	SIEMENS	5SY4216-7	2	
2	MCB11, MCB12	MINIATURE CIRCUIT BREAKER	2P/400VAC/60VDC/10kA/10AT-C	SIEMENS	5SY4210-7	2	
3	MCB13...15	MINIATURE CIRCUIT BREAKER	2P/400VAC/60VDC/10kA/2AT-C	SIEMENS	5SY4202-7	3	
4	MCB201, MCB202	MINIATURE CIRCUIT BREAKER	1P/230VAC/60VDC/10kA/6AT-C	SIEMENS	5SY4106-7	2	
5	MCB101...104	MINIATURE CIRCUIT BREAKER	1P/230VAC/60VDC/10kA/4AT-C	SIEMENS	5SY4104-7	4	
6	MCB105	MINIATURE CIRCUIT BREAKER	1P/230VAC/60VDC/10kA/2AT-C	SIEMENS	5SY4102-7	1	
7	-	BUSBAR FOR MCB	10mm2/FOR 2P MCB	SIEMENS	5ST3735	-	
8	-	BUSBAR FOR MCB	10mm2/FOR 1P MCB	SIEMENS	5ST3731	-	
9	PS11	POWER SUPPLY	100-240VAC/24VDC 10A	PHOENIX CONTACT	QUINT PS/1AC/24DC/10	1	
10	PS12	POWER SUPPLY	100-240VAC/24VDC 20A	PHOENIX CONTACT	QUINT PS/1AC/24DC/20	1	
11	FAN13A	VENTILATION FAN	230VAC/50Hz/19W/87m3/h/204x204mm/RAL7035	RITTAL	SK 3325.107	1	
12	FLT1A, FLT1B	OUTLET FILTER	204x204mm/RAL7035	RITTAL	SK 3325.207	2	
13	TS13A	ENCLOSURE INTERNAL THERMOSTAT	230/115/60/48/24VAC _ 60/48/24VDC	RITTAL	SK 3110.000	1	
14	FL14A, FL14B	PANEL LIGHT	100-240V/14W/with DOOR SWITCH	RITTAL	SZ 2500.110	2	CABLE: SZ 2500.400
15	SK15	RECEPTACLE	250V/16A/CF Type	PHOENIX CONTACT	EO-CF-UT/LED/GN	1	
16	DP1	DOCUMENT POCKET	228x254x17 (A4)	RITTAL	SZ 2514.000	1	
17	PB1, PB2	EMERGENCY STOP PUSH BUTTON	2NC/220VAC_3A/24VDC_1.5A/MAINTAINED/RED/MASHROOM	SCHNEIDER	XB7NS8442	2	LABEL: A22Z-3466-1 PROTECTION COVER: A22Z-EG1
18	X1(L1,N1,L2,N2)	TERMINAL BLOCK	1000V/125A/GRAY/1.5-35.0mm2	PHOENIX CONTACT	UT 35	4	
19	X1(PE)	TERMINAL BLOCK	1000V/125A/GREEN-YELLOW/1.5-35.0mm2	PHOENIX CONTACT	UT 35-PE	1	
20	X1(FE,ISE)	TERMINAL BLOCK	1000V/125A/GREEN/1.5-35.0mm2	PHOENIX CONTACT	UT 35 GN	2	
21	X4,X5	TERMINAL BLOCK	500V/32A/GRAY/0.14-4.0mm2/4 COONECTION	PHOENIX CONTACT	UT 4-QUATTRO	34	END PLATE: D-UT 2.5/4-QUATTRO, BRIDGE: FBS **-6
22	X6,X7	TERMINAL BLOCK	500V/24A/GRAY/0.14-2.5mm2/4 CONNECTION	PHOENIX CONTACT	UT 2.5-QUATTRO	6	END PLATE: D-UT 2.5/4-QUATTRO, BRIDGE: FBS **-5
23	X6,X7 (PE)	TERMINAL BLOCK	8kV(surge voltage)/GREEN-YELLOW/0.14-2.5mm2	PHOENIX CONTACT	UT 2.5-PE	5	END PLATE: D-UT 2.5/10, BRIDGE: FBS **-5
24	X11..14, X21, X24, X31	TERMINAL BLOCK	400V/20A/GRAY/0.14-2.5mm2/KNIFE DISCONNECT	PHOENIX CONTACT	MTK-P/P / 3104013	228	END PLATE: D-UT 2.5/4-TWIN, BRIDGE: FBS **-5
25	X11..14, X21, X24, X31, X32, X33 (FE)	TERMINAL BLOCK	1000V/24A/GREEN/0.14-0.25mm2	PHOENIX CONTACT	UT 2.5 GN	152	END PLATE: D-UT 2.5/10, BRIDGE: FBS **-5
26	X22, X23 (L+)	TERMINAL BLOCK	24VDC/6.3A/FUSE(5x20)/LED/BLACK/0.14-4.0mm2	PHOENIX CONTACT	UT 4-HESI LED24	40	BRIDGE: FBS **-6
27	X22, X23 (M)	TERMINAL BLOCK	1000V/41A/GRAY/0.14-4.0mm2	PHOENIX CONTACT	UT 4	40	END PLATE: D-UT 2.5/10, BRIDGE: FBS **-6
28	X22, X23 (FE)	TERMINAL BLOCK	1000V/41A/GREEN/0.14-4.0mm2	PHOENIX CONTACT	UT 4 GN	51	END PLATE: D-UT 2.5/10, BRIDGE: FBS **-6
29	X32, X33	TERMINAL BLOCK	400V/20A/BLUE/0.14-2.5mm2/KNIFE DISCONNECT	PHOENIX CONTACT	UT 2.5-MT BU	76	END PLATE: D-UT 2.5/4-TWIN, BRIDGE: FBS **-5
30	-	END TERMINAL BLOCK	MOUNTING END CLAMP FOR DIN RAIL	PHOENIX CONTACT	CLIPFIX 35	-	-
31	-	DIN RAIL	DIN RAIL NS 35	-	-	-	ESTIMATED LENGTH: 14m
32							
33	SR1, SR2	SAFETY RELAY	24VAC_DC/8X1/1X2	PHOENIX CONTACT	PSR-SCP-24UC/ESAM4/8X1/1X2	2	
34	R100..123, R208..215, R224..231 R300..305	RELAY	24VDC(Coil)/230VAC_3A/24VDC_2A/SPDT	PHOENIX CONTACT	PLC-RSC-24DC/21	46	BRIDGE: FBST 500-PLC RD/BU
35	R200..207, R216..223	SSR	24VDC(Coil)/3V..33VDC_2A	PHOENIX CONTACT	PLC-OSC-24DC/24DC/2	16	BRIDGE: FBST 500-PLC RD/BU

0	6/01/25	First Issue	SV	-	-	-	-
REV.	ISSUE DATE	DESCRIPTION	PREPARED	CHECKED	APPROVED	COMPANY	
CLIENT:			CONSULTING ENGINEER:				
VENDOR:							
PROJECT: PR200							
DRAWING TITLE: PLC Wiring and Layout Drawing							
DRAWING NO.			REV.	SIZE	SCALE	SHEET	
E1027-HSE-VD-IN-DIG-008			RO	A3	NA	39/40	

NO.	TAG NO.	INSTRUMENT/PARTS NAME	SPEC/SERVICE	MANUFACTURER	MODEL/CODE	QTY.	REMARKS
36	A1	PLC COMMUNICATION MODULE	MODBUS RTU 485	SIEMENS	6ES7241-1CH32-0XB0	1	
37	A2	PLC CPU MODULE	CPU1217C	SIEMENS	6ES7217-1AG40-0XB0	1	MEMORY CARD 24MB: 6ES7954-8LF04-0AA0
38	A3,A4,A5,A6	PLC DIGITAL INPUT/OUTPUT MODULE	DI16/DO16/24VDC/0,5A	SIEMENS	6ES7223-1BL32-0XB0	4	
39	A7,A8,A9	PLC ANALOGUE INPUT MODULE	A18/24VDC	SIEMENS	6ES7231-4HF32-0XB0	3	
40	A10	PLC ANALOGUE OUTPUT MODULE	A04/24VDC	SIEMENS	6ES7232-4HD32-0XB0	1	
41	HMI1	OPERATOR PANEL	TP1200-COMFORT /24VDC/12" COLOR	SIEMENS	6AV2124-0MC01-0AX0	1	
42	PR10	UNIVERSAL POWER RAIL	24VDC/4A	PEPPERL+FUCHS	UPR-3S	1	
43	MPS10	POWER FEEDER MODULE	20..30VDC/4A/W20mm	PEPPERL+FUCHS	KFD2-EB2	1	
44	M11..18, M21..28, M31..36	ISOLATED BARRIER	19..30VDC/W12.5mm/2W TRANSMITTER/HART	PEPPERL+FUCHS	KCD2-STC-EX1	22	
45	M41,42	ISOLATED BARRIER	19..30VDC/W20mm/IP CONVERTER/HART	PEPPERL+FUCHS	KFD2-SCD2-EX1.LK	2	
46	CAB1	INDUSTRIAL ETHERNET CABLE	INDUSTRIAL ETHERNET CABLE 3M WITH 2X RJ45 CONN.	SIEMENS	6XV1870-3QH30	1	
47							
48							
49							
50	-	CABINET ENCLOSURE MODEL	-	RITTAL	VX 8808.000/vx 8108.245	1	
51	-	CABINET ENCLOSURE 2ND MOUNTING PLATE	-	RITTAL	VX5051.043/5051.045	1	
52	-	CABINET ENCLOSURE BASE	-	RITTAL	VX 8640.003/VX8640.034	1	
53	-	CABINET ENCLOSURE DOOR LOCK	-	RITTAL	VX8618.250/2467000	1	
54	-	CABINET ENCLOSURE CABLE ENTRY	-	RITTAL	VX88020850	1	
55							
56							
57							
58							
59							
60							
61							
62							
63							
64							
65							
66							
67							
68							
69							
70							

0	6/01/25	First Issue	SV	-	-	-	-
REV.	ISSUE DATE	DESCRIPTION	PREPARED	CHECKED	APPROVED	COMPANY	
CLIENT:			CONSULTING ENGINEER:				
VENDOR:							
PROJECT: PR200							
DRAWING TITLE: PLC Wiring and Layout Drawing							
DRAWING NO.			REV.	SIZE	SCALE	SHEET	
E1027-HSE-VD-IN-DIG-008			RO	A3	NA	40/40	